

Mr. & Mrs. Alexander Sadowski

U.S. DEPARTMENT OF COMMERCE

WEATHER BUREAU

RESEARCH PAPER NO. 41

The Tornadoes at Dallas, Tex., April 2, 1957

U.S. DEPARTMENT OF COMMERCE

FREDERICK H. MUELLER, Secretary

WEATHER BUREAU

F. W. REICHELDERFER, Chief

RESEARCH PAPER NO. 41

The Tornadoes at Dallas, Tex., April 2, 1957

A Collection of Reports by

WALTER H. HOECKER, JR.

ROBERT G. BEEBE

DANSY T. WILLIAMS

JEAN T. LEE

STUART G. BIGLER

E. P. SEGNER, JR.



WASHINGTON, D.C.

1960

TABLE OF CONTENTS

	Page
Introduction.....	1
The Life Cycle of the Dallas Tornado.....	3
The Dimensional and Rotational Characteristics of the Tornadoes and Their Cloud System.....	53
The Synoptic Situation.....	114
The Role of a Subsidence Layer.....	143
A Summary of Eyewitness Interviews.....	159
Estimates of Minimum Wind Forces Causing Structural Damage.....	169

The Tornadoes at Dallas, Tex., April 2, 1957

INTRODUCTION

WALTER H. HOECKER, JR.

U.S. Weather Bureau, Washington, D.C.

The study of the tornadoes of April 2, 1957, at Dallas, Tex., presented here is an assembly of independent efforts on some of the important aspects of these tornadoes and the associated weather situation. It is not intended as an exhaustive study. Initially, R. G. Beebe of the Kansas City Severe Local Storms Forecast Unit and W. H. Hoecker of the Severe Local Storms Research Unit, Washington, D.C., prepared separate studies using portions of the large number of photographs taken of these tornadoes. When it was learned of other studies that were being prepared by personnel of the Severe Local Storms Forecast Unit at Kansas City, and by contract tornado investigators of the Texas A. & M. Research Foundation, Dr. H. Wexler, Director of Meteorological Research, U.S. Weather Bureau, suggested that all these efforts be assembled into a single research paper. The papers are published in full as submitted, with the exception that the contributions of S. G. Bigler and E. P. Segner of the Texas A. & M. Research Foundation (contract investigators for the Weather Bureau) are condensations of their original contract reports. This was necessitated by the length of their contributions.

The series of photographs of the Dallas tornadoes presented in the first report of this paper by Beebe results from his interest in collecting all possible tornado photographs for the purpose of obtaining clues to the mechanics and origin of tornadoes.

The second report, based on a photogrammetric analysis of tornado photographs, applies techniques of photogrammetry used many years ago but revived by Hoecker in an earlier tornado study, for which a large number of tornado pho-

tographs also had been collected. Considerable information about the size and structure of tornadoes can be obtained from such studies of tornado sequence pictures.

The third report of the series, by J. T. Lee of the Weather Bureau Severe Local Storms Forecasting Center and the research staff of the Kansas City District Meteorological Office, stems from Mr. Lee's long interest in forecasting tornadoes and severe local storms and in the mechanisms causing them.

D. T. Williams, of the research staff of the Kansas City District Meteorological Office, who contributed the fourth report, has also had a longtime interest in severe local storms. His particular interest has been in the effect of inversions and subsidence layers in delaying the release of potential convective energy in the severe storms area of the United States.

The fifth report, submitted by S. G. Bigler, then of the research staff of the Texas A. & M. Research Foundation and now with the Weather Bureau, is the result of his particular interest in the radar aspects of severe local storms and in collecting data from all manifestations of the tornado, such as eyewitness accounts, damage effects, and photographs, to mention a few items.

The last report, by E. P. Segner, Jr., a registered professional engineer, involving computations of wind speeds needed to cause certain structures to yield, is a realistic approach to the tornado wind speed problem. The main drawback of the method is that it yields minimum wind speeds required to cause the observed effects—not the total speed that occurred or that might have occurred.

The matter of public response to tornado warn-

ings was discussed by Bigler in the fifth report of this series and also by M. C. Harrison, Meteorologist in Charge, U.S. Weather Bureau Office at Dallas, in a communication¹ with the Director of Meteorological Research. Bigler found that citizens of Dallas thought tornado forecasts were of value, but found that they knew little or nothing of personal safety rules regarding an encounter with a tornado. Harrison, on the other hand, thought that public broadcasting of personal safety rules had helped some people to take the best possible cover when they realized that a tornado was endangering them.

¹ Mr. Harrison's views are contained in a memorandum to the Director of Meteorological Research, dated Oct. 7, 1958.

Here then under one cover is the most thoroughly studied tornado situation known at this date. In addition, it is different from most tornado studies in that instead of offering mere qualitative descriptions involving freak damage, considerable quantitative results are presented. The tornado funnels, for example, have been scaled from start to finish and the dimensions of the parent cloud have been determined; the engineering report contains computations on the actual wind speeds needed to cause the observed effects; and in the study of the subsidence layer quantitative stability figures are used. It is hoped that the reader will obtain a better understanding of tornadoes in general as a result of considering the material presented in this tornado research paper.

THE LIFE CYCLE OF THE DALLAS TORNADO

ROBERT G. BEEBE*

U.S. Weather Bureau, Kansas City, Mo.

[Manuscript received September 19, 1958; revised October 27, 1959]

ABSTRACT

A series of photographs of the funnel of the Dallas 1957 tornado is described and keyed into a second series showing the damage done by the tornado.

The Dallas tornado of April 2, 1957, afforded tornado researchers the first opportunity to study the complete life cycle of a tornado from photos of the funnel and destruction on the ground. Although thousands of tornado photos have been taken since the development of cameras over 100 years ago, most of these are single shots or a rapid sequence of photos from the same location. Until the Dallas tornado there was not a single case in which the complete life cycle of a tornado vortex was recorded photographically, although the Scottsbluff tornadoes of June 27, 1955, [1] did provide the first clues regarding the life cycle. The purpose of this report is to illustrate and describe the first photographic record of the complete life cycle of a tornado.

The Dallas tornado occurred around 4:30 p.m., CST, and lighting conditions for photography were good. The tornado was within sight of many thousands of persons so that many photos were taken. The Weather Bureau's records include over 450 black-and-white photos, 250 color transparencies, and nearly 2,000 feet of movie film. These photos were taken by some 125 photographers from even more locations at varying distances and from different sides of the tornado. From these many photos, representative shots illustrative of the tornado's life cycle were selected, and are shown here.

In addition to these complete and detailed photographic records, this tornado occurred in an area where radar data, upper air observations, surface observations (the tornado dissipated about a mile from the Weather Bureau station at Love Field), and many eyewitness accounts

were available. Thus, this tornado was observed in more detail than any other in history.

The day after the Dallas tornado, Mr. Stuart G. Bigler, Project Supervisor of the Texas A. & M. Tornado Damage Survey Team, working under U.S. Weather Bureau Contract Cwb-9116 [2], went to Dallas to conduct the damage survey. From a chartered airplane, Mr. Bigler obtained aerial photos of the entire length of the tornado damage path. Representative photos from this series are shown in connection with individual funnel photos.

A map of Dallas showing the tornado path, the location of the photographers as they snapped the photos illustrated here, and the tornado location along the path at the time of the respective photo is shown in figure A. The tornado location was determined by setting up a theodolite at the photographer's location for each photo. The azimuth of the theodolite was set on the basis of street bearings from detailed Dallas maps. The large numbers in figure A refer to the tornado photos to follow and each photographer's name is placed near a circle showing the location from which he took the photos. The dashed lines show the path along which the camera was pointed. Known times, indicated along the track in CST, were obtained from records of the Dallas Power & Light Co., containing the times of severance of powerlines.

The first photograph, figure B, was taken at 1530 CST from the campus of Southern Methodist University, which is about 2 miles north of Poynter's location, about an hour before the Dallas tornado developed. The camera was pointed to

*Present affiliation: Midwest Weather Service, Kansas City, Mo.

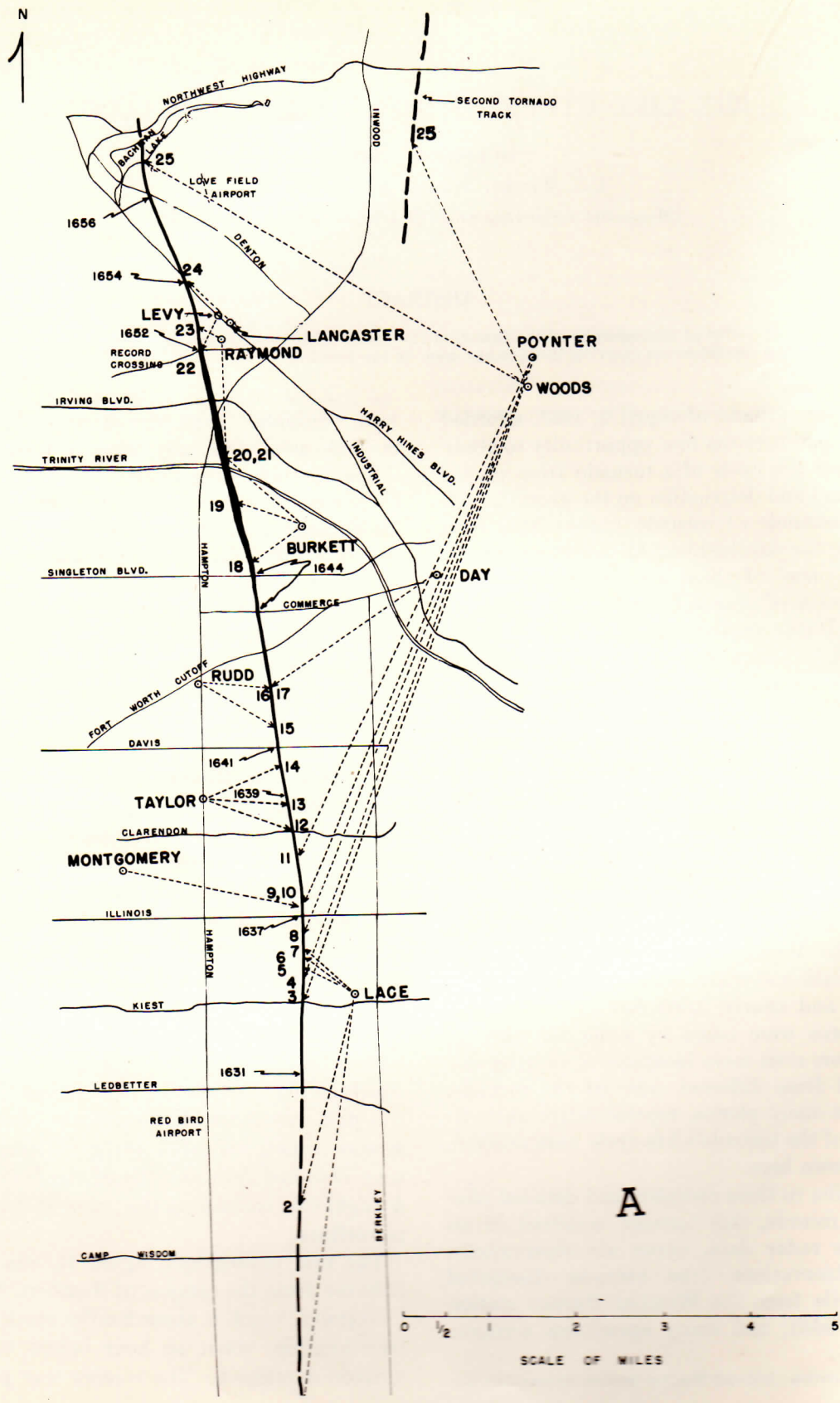

A

the no
of th



the north and the photographer, Mr. Clint Grant, of the *Dallas Morning News*, stated that: "A

prominent dark cloud was going southwest; the cumulus in the back was boiling." Although it is

doubtful that the cloud could have moved south-westward against the general southerly flow, this photo does show that convective clouds were at least in the vicinity, whereas some witnesses described the clouds as definitely of the stratus type.

Photo No. 1 was taken at about the time the tornado was forming. Several witnesses described the bulge and intermittent funnel-shaped cloud wisps as very turbulent and with an ominous appearance. Mr. Ed Lace, the photographer, explained that, although he had never seen a tornado and had no knowledge that this formation would develop into one, he took this and some subsequent photos because of the interesting cloud formations. The height of the cloud base above the ground (ceiling) was estimated at 600 to 800 feet near Redbird Airport.

Photo No. 2 was taken about 5 minutes after No. 1. Note that the funnel-shaped wisp had completely disappeared at this time. A dust whirlwind on the ground was occasionally visible to observers in the area, but is not visible in the photo.

Photo No. 3 illustrates the incipient tornado (see arrow) some 5 minutes later and after slight damage occurred on the ground. Even so, the tornado is hardly in evidence at the cloud base here; none of the cloud protuberances would be identified as a tornado by most observers at this stage. Note that the cloud base is a little lower (see the arrow) in the vicinity of the forming

tornado than at either side. Photo No. 3a illustrates the damage at 1631 which was 1 mile upstream along the tornado track, or about 2 minutes before the photo shown in No. 3. Some scattering of lumber from the house under construction may be observed at the left-hand side of the damage photo No. 3a. In the center of the photo another house under construction suffered more damage. At the time of the tornado the wall studs were in place and were all knocked down. At the completed home (with three cars in the driveway) between these two points a picture window was blown out and the north wall was also shifted outward.

Photo 4 shows some funnel development (at the arrow) which occurred during the very short time interval between photos 3 and 4. Photo 5, taken at a distance of less than three-quarters of a mile, shows further funnel development (see arrow). At the time of these two photos, only minor, intermittent damage was occurring at the ground.

Photo 6 shows additional funnel development (at the arrow) a little later, and here the dust whirl on the ground may be noted. At this time, the tornado was near the intersection of Saner and Garapan Streets, and the dust seen in photo 6 may be from the street.

Photo 7 shows increased funnel development (see arrow) and lowering, plus large pieces of debris rising into the air. This possibly is the rooftop that is missing from one of the two houses shown in the upper center of aerial damage photo No. 7a (see arrow). During this formative stage, the strength of the tornado was gradually increasing as evidenced by the extent of the damage. The condensation funnel appeared to form and lower gradually. The path width at the ground remained very narrow, not exceeding 10 yards, and the damage was spotty.

Photo 8, taken only seconds later, shows additional development and lowering of the condensation funnel and more dust around the base of the dust whirl. Note that a kink in the condensation funnel is forming about midway between the cloud base and the ground. Photo 8a shows spotty, minor damage, mostly to roofs. From this point northward along the track, the extent of damage became more intense, and the path width increased slightly. Also, the destruction slowly became continuous.

Photo 9 was taken from a point northeast of

PHOTO CREDITS

E. H. LACE, 3103 Eisenhower, Dallas 34, Tex.

CARL A. POYNTER, 4024 Swiss Avenue, Dallas 4, Tex.

MRS. CHARLES H. MONTGOMERY, 3115 Wilton Avenue, Dallas 11, Tex.

STEPHEN TAYLOR STUDIO, 609 South Hampton Road, Dallas, Tex.

RUDD STUDIO, 2121 West Colorado, Dallas, Tex.

ROBERT E. DAY, 2533 Engle, Dallas 33, Tex.

CHARLES B. RAYMOND, 6026 Wyche Boulevard, Dallas, Tex.

MAURICE LEVY, NBC News, Dallas, Tex.

EDWARD G. WOODS, 508 Eugene Street, Longview, Tex.

BILL BURKETT, Commercial Photographers, Inc., 1104 Main, Dallas, Tex.

J. D. LANCASTER, Joy Manufacturing Co., 6540 Hines Boulevard, Dallas 35, Tex.

All damage photos by Tornado Damage Survey Project, Texas A. & M. College, College Station, Tex.

the tornado at the same time photo 10 was taken west-northwest of the tornado. From this time and during the next 2 minutes, the intensity of the tornado increased markedly. Damage photo 10a shows mostly roof damage, but 10b illustrates the first example wherein the tornado moved a building (note the white house near the center of the photo that has been shifted off its foundation).

Photo 11 is the first photo showing the condensation funnel extending to near the surface. At this time the destruction became nearly continuous so that all buildings in the path were damaged as may be observed in damage photos Nos. 11a and 11b. This condition lasted only a very short time, extending along a two-block path.

Photos 12, 13, and 14 show that the condensation funnel does not reach the ground. During this time the spread of the damage was a little less extensive as illustrated in damage photos 12a, 13a, 13b, and 14a.

Photo 15 shows considerable dust near the ground but no debris in the air. The vortex is somewhat ragged and the condensation funnel does not extend to the ground. Although considerable damage occurred, most of it was to roofs as may be noted in damage photo 15a. Photos 16 and 17, taken at the same time, show the same type of formation a half-mile farther along the track. Damage photo 16a shows a continuation of the roof and minor structural house damage.

Photo 18 was taken shortly after the tornado developed a marked increase in strength. It may be noted that the condensation funnel does not reach the ground. Damage photos Nos. 18a and 18b illustrate the marked increase in both destruction and path width. Damage photo 18c illustrates the destruction between funnel photos 18 and 19.

Photo 19 is the first closeup photo showing the condensation funnel on the ground. Here the path was marked by complete destruction to all buildings and was also much wider, as illustrated in damage photos 19a and 19b. Most of the injuries and loss of life occurred in the residential area shown here.

Photos 20 and 21 were taken at nearly the same time and near the time the tornado was at its maximum intensity. Fortunately, this occurred over open country along the Trinity River; no damage photos were taken here. Note that the photo taken with the camera pointed to the north-

west (No. 20) shows no appreciable curvature of the funnel, while the photo taken looking to the south (No. 21) shows a marked curvature. Thus, the base of the funnel was curved toward the southeast.

Photo 22 is an enlargement from a 16-mm. film and shows buildings being lifted into the air and exploding. These buildings were of light frame construction, and were set on piers with about 8-foot centers. Damage photos 22a and 22b illustrate the extent of the damage here. Note that some of the boxcars (some having a gross weight in excess of 50 tons) were overturned.

Photo 23 shows the tornado during the final stage and after it had passed the period of maximum intensity. Note that the condensation funnel is narrow even though the photo was taken from a distance of only 1,100 feet. Also, breaks are developing in the condensation funnel. Damage photo 23a illustrates the extent of damage. Much of the path in this area was over unimproved ground.

Photo 24 shows further dissipation of the tornado as it crossed Harry Hines Boulevard. Although damage photo 24a shows considerable destruction just before the tornado crossed Harry Hines, a Dallas policeman drove his car through the tornado here without sustaining any damage. Photos 24b and 24c show continued, though decreasing, damage as the tornado gradually dissipated.

A number of photos were taken in rapid succession showing the final stages of this tornado. The top of the vortex (at the cloud base) was three-quarters of a mile northeast of the tip of the vortex on the ground at the time the lower part dissipated. During this final stage the vortex was very small in diameter and knots, bends, breaks, etc., developed and moved rapidly along the vortex. The ceiling at Love Field at this time was 2,500 feet. (See Hoecker's sketches 49-51, pp. 82 and 85.)

Photo 25 shows the dissipating stage of the tornado just described, and, about 2.5 miles to the east (to the right in the photo), the formative stage of another tornado. This second tornado, appearing larger since it is closer, caused some minor damage over the north part of Dallas but did not reach its full force until it was over open country well north of Dallas. It was this tornado that Julius Hudson, Dallas pilot, flew near and described in considerable detail.



SUMMARY

From the time of the first photograph of the Dallas tornado until it began to cause damage at the ground the shape of this tornado was such that it would not be identified as a tornado by most persons. The incipient tornado moved at least 5 miles (about 11 minutes) before a vortex became visible. Although some damage occurred during this time, it was spotty and minor. The extent of the damage then increased gradually; the "skips" became less frequent, the path width increased very slightly, and the condensation fun-

nel slowly lowered to the ground. The distance covered by the tornado from the maturing stage to the point where the tornado reached its maximum intensity was 5 miles; this it covered during an 11-minute period. (There was a short period when the condensation funnel extended to at least near the surface and with continuous damage over a distance of one or two blocks.) Shortly before the condensation funnel lowered to the ground the extent of the damage increased markedly, the path widened to near 200 feet from

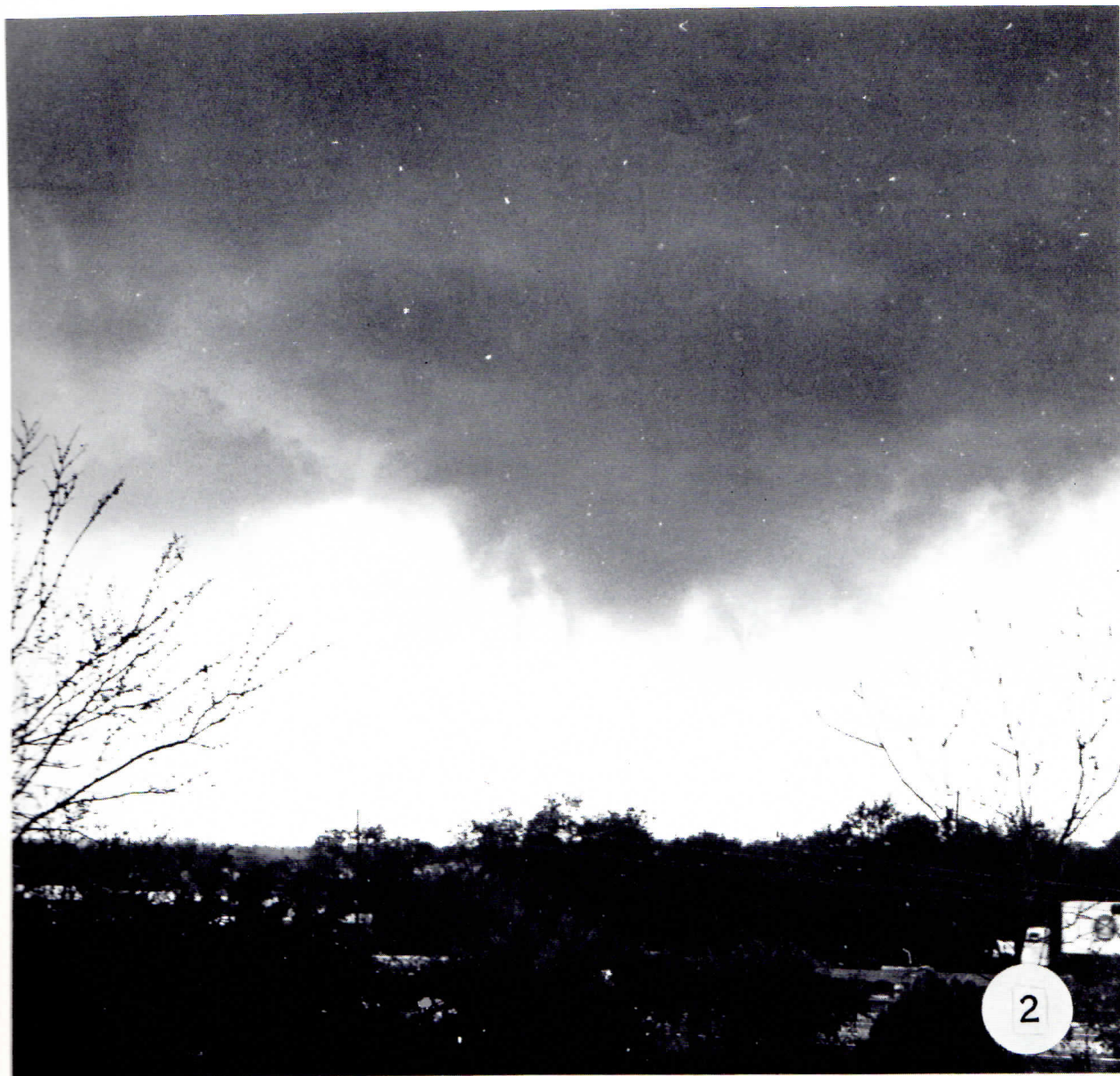

about 30 to 50 feet, and the destruction was complete and without "skips." The tornado maintained this maximum intensity during the next 3 miles.

Then the vortex became smaller in diameter,

the path width decreased, gaps and knots developed in the vortex, the cloud base became appreciably higher, and, finally, the vortex at the ground lifted or dissipated. The path length of this final stage was about 2 miles.

REFERENCES

1. R. G. Beebe, "Notes on Scottsbluff, Nebraska, Tornadoes, June 27, 1955," *Bulletin of the American Meteorological Society*, vol. 40, No. 3, March 1959, pp. 109-116.
2. Stuart G. Bigler, "The Dallas Tornado of 2 April 1957," *Scientific Report No. 2*, Contact Cwb-9116, Department of Oceanography and Meteorology, Agricultural and Mechanical College of Texas, College Station, Tex., August 1957.

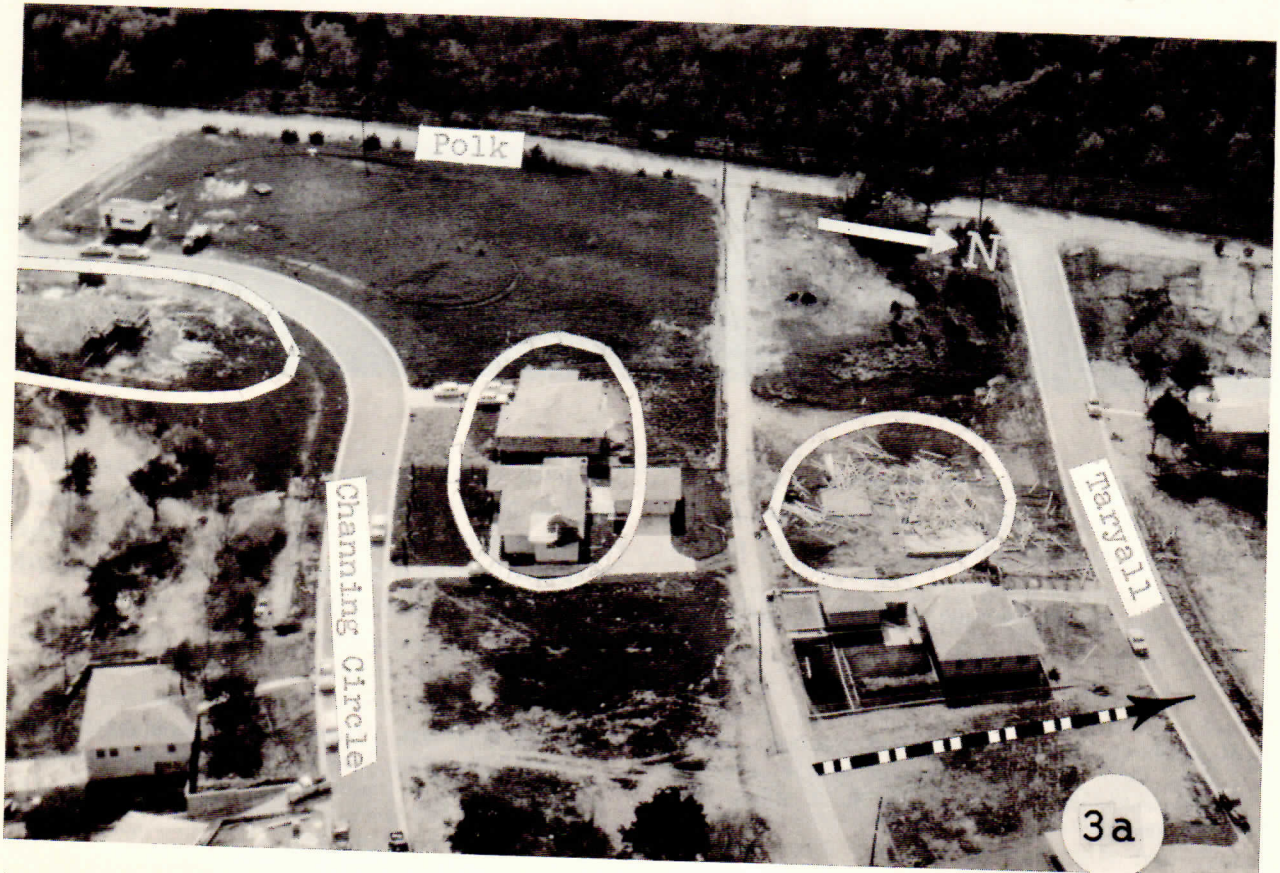



3

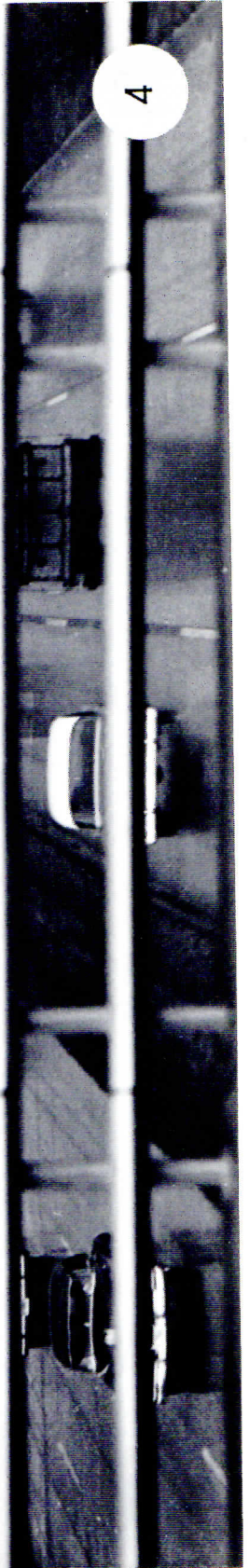

4



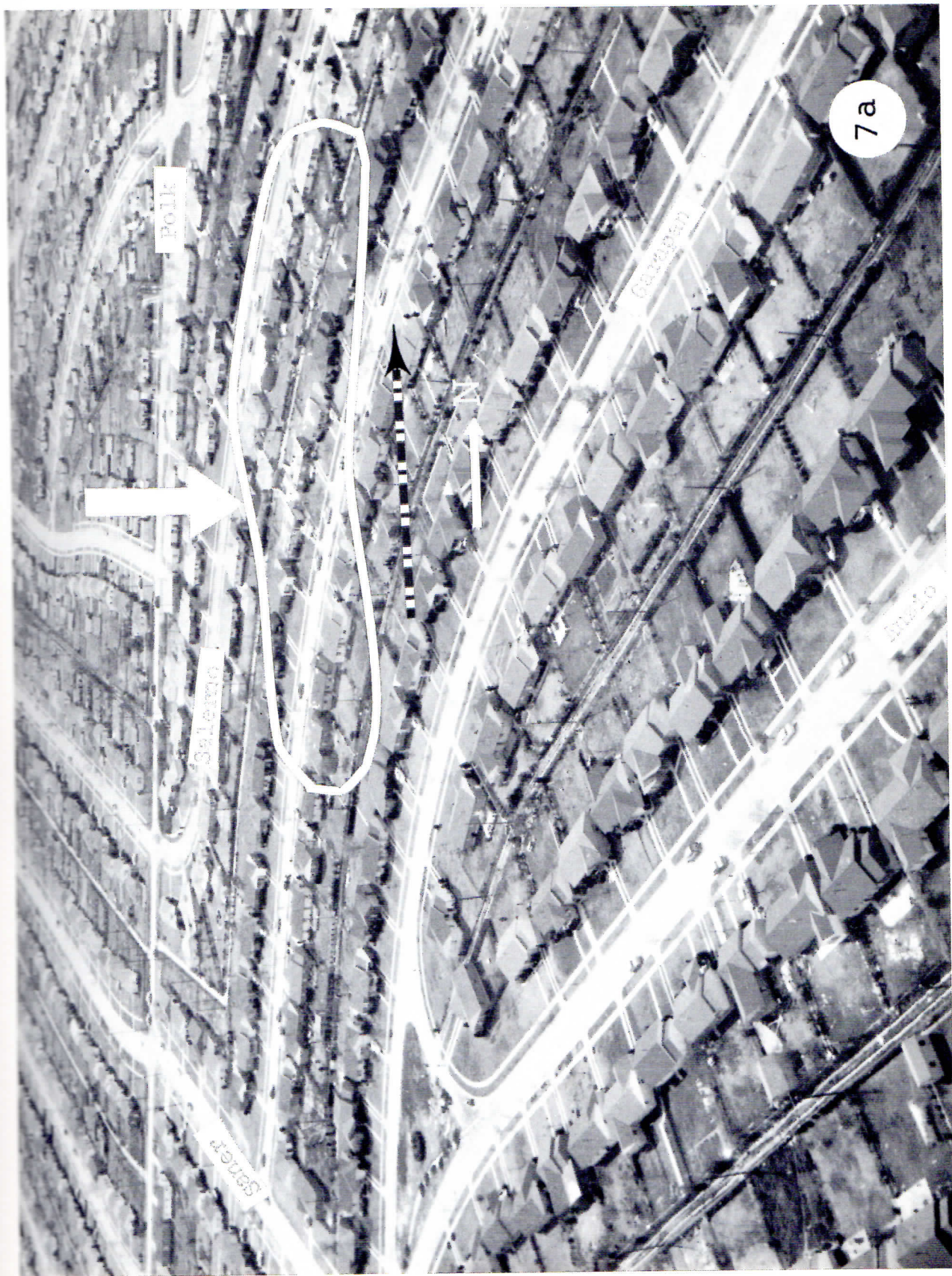



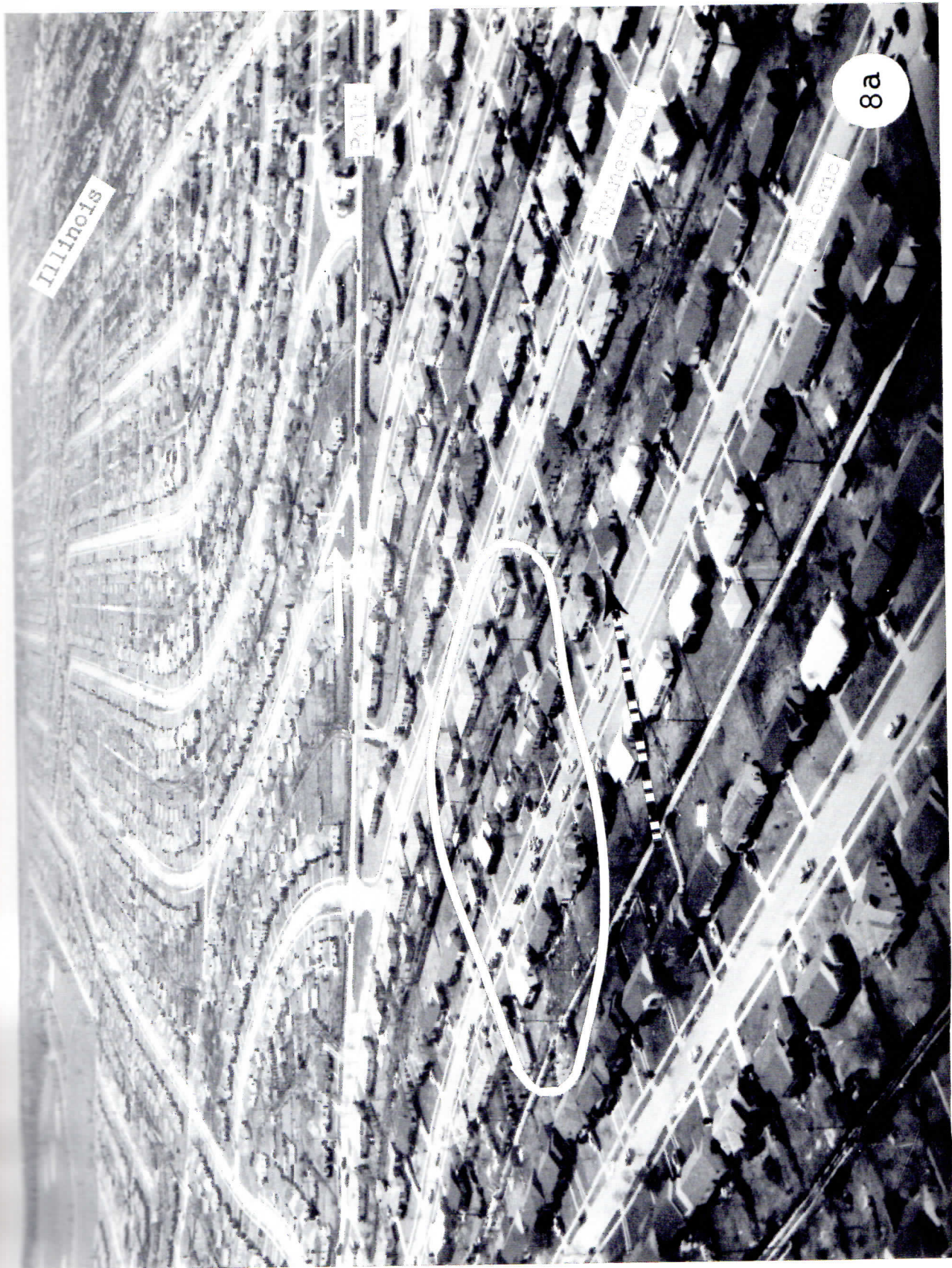





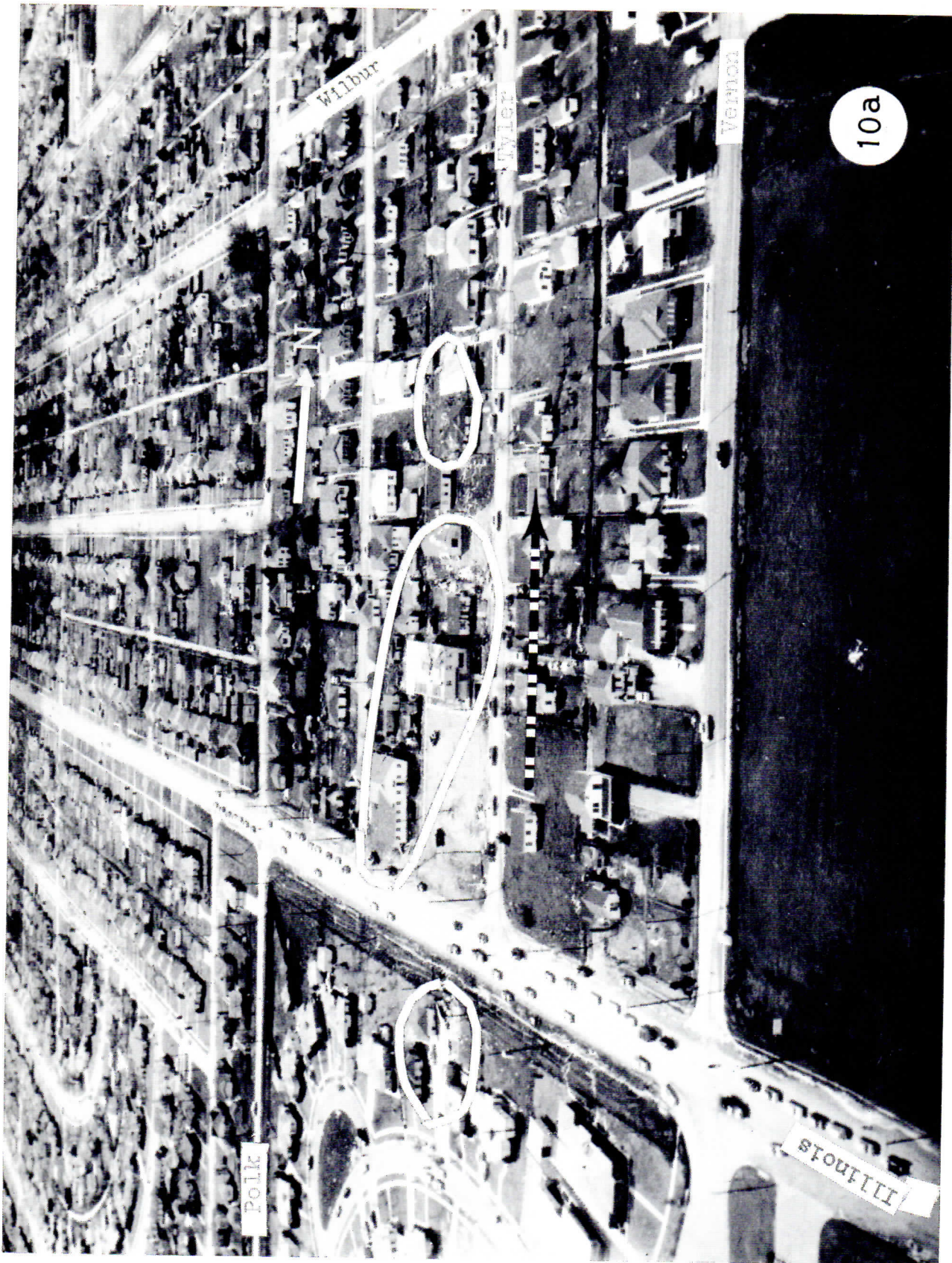

10a

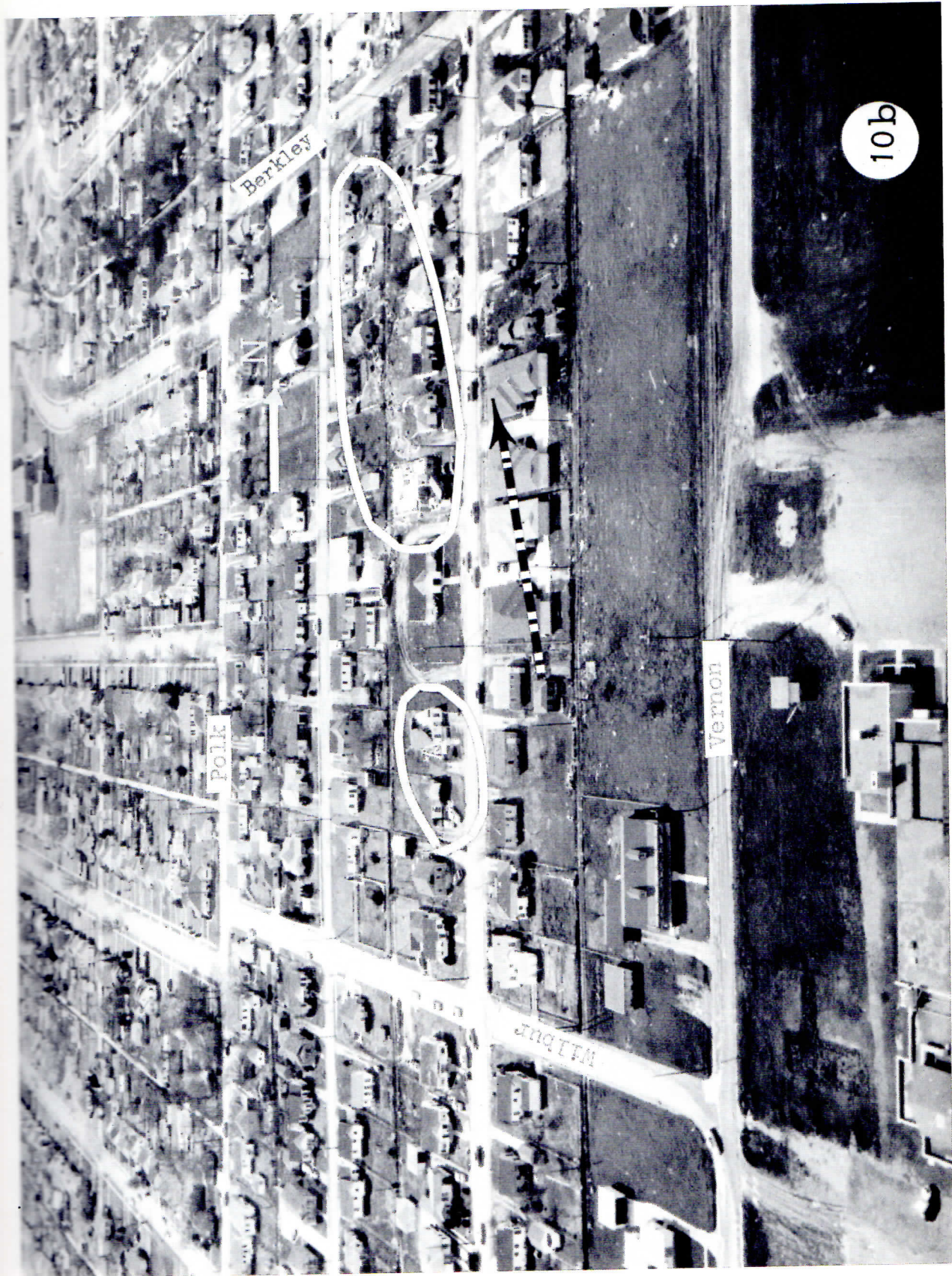

10b



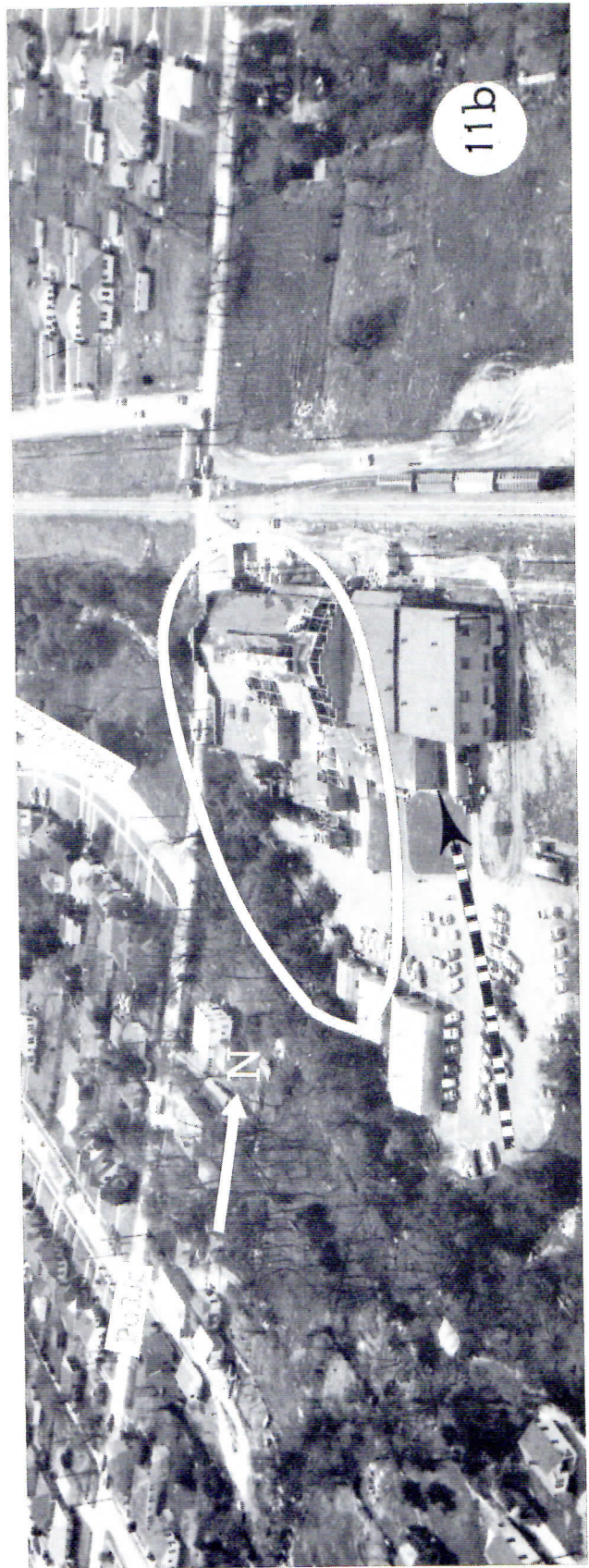
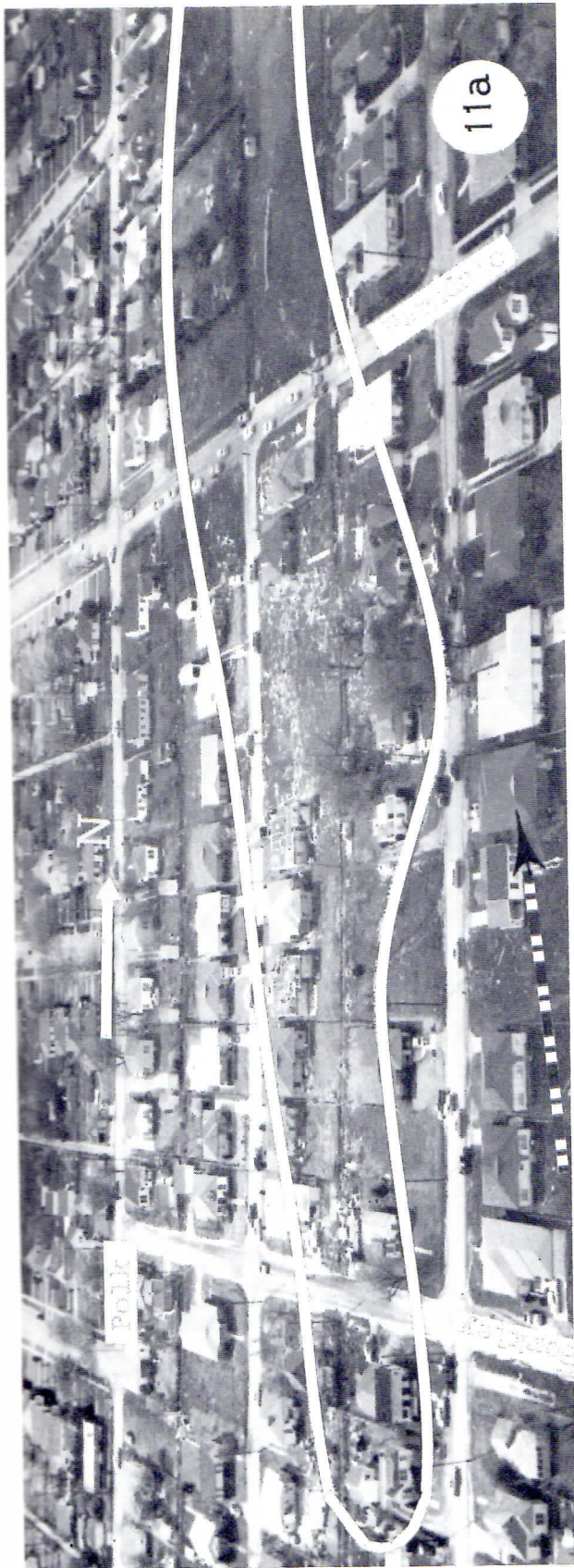



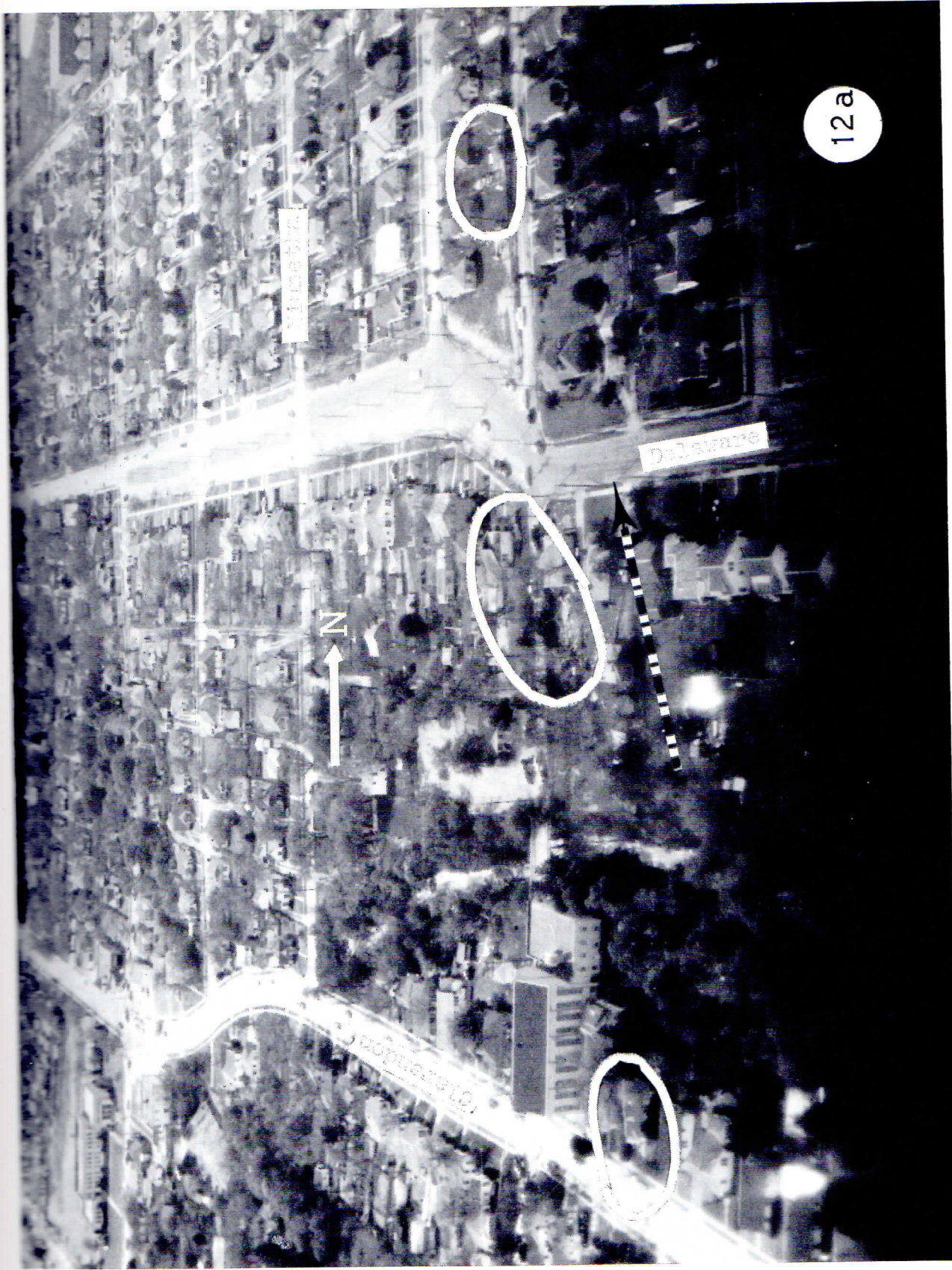

12a



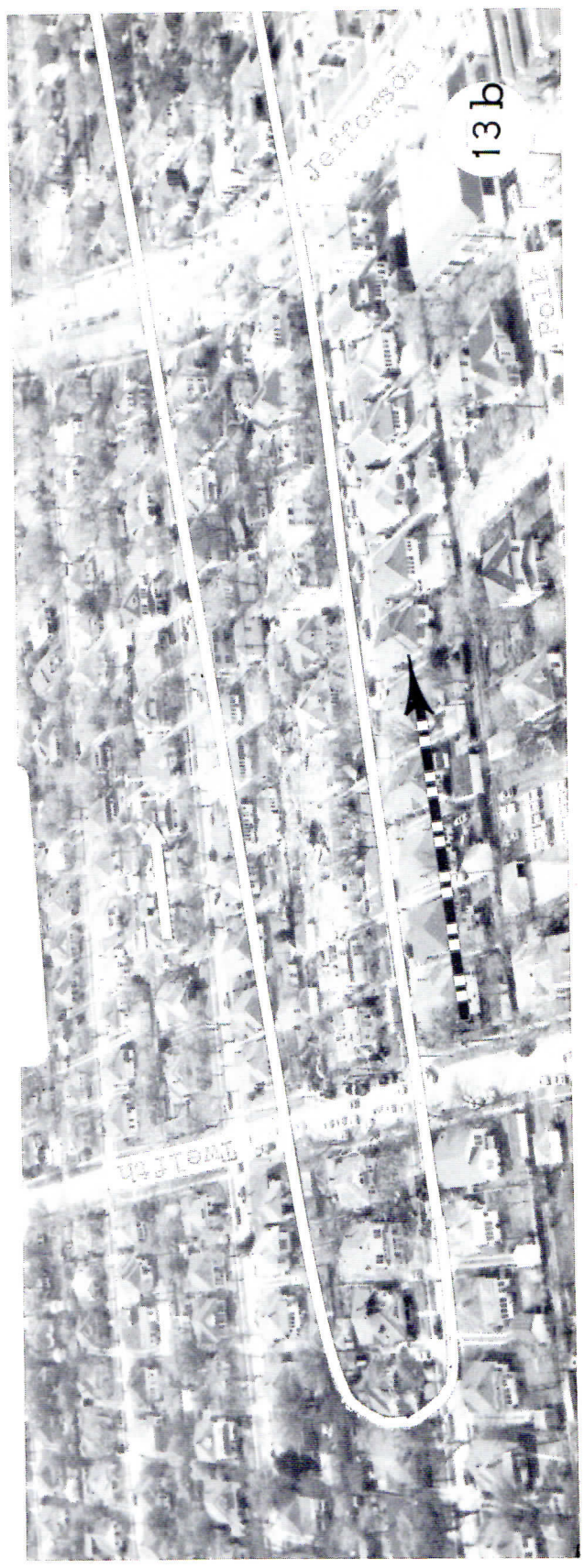



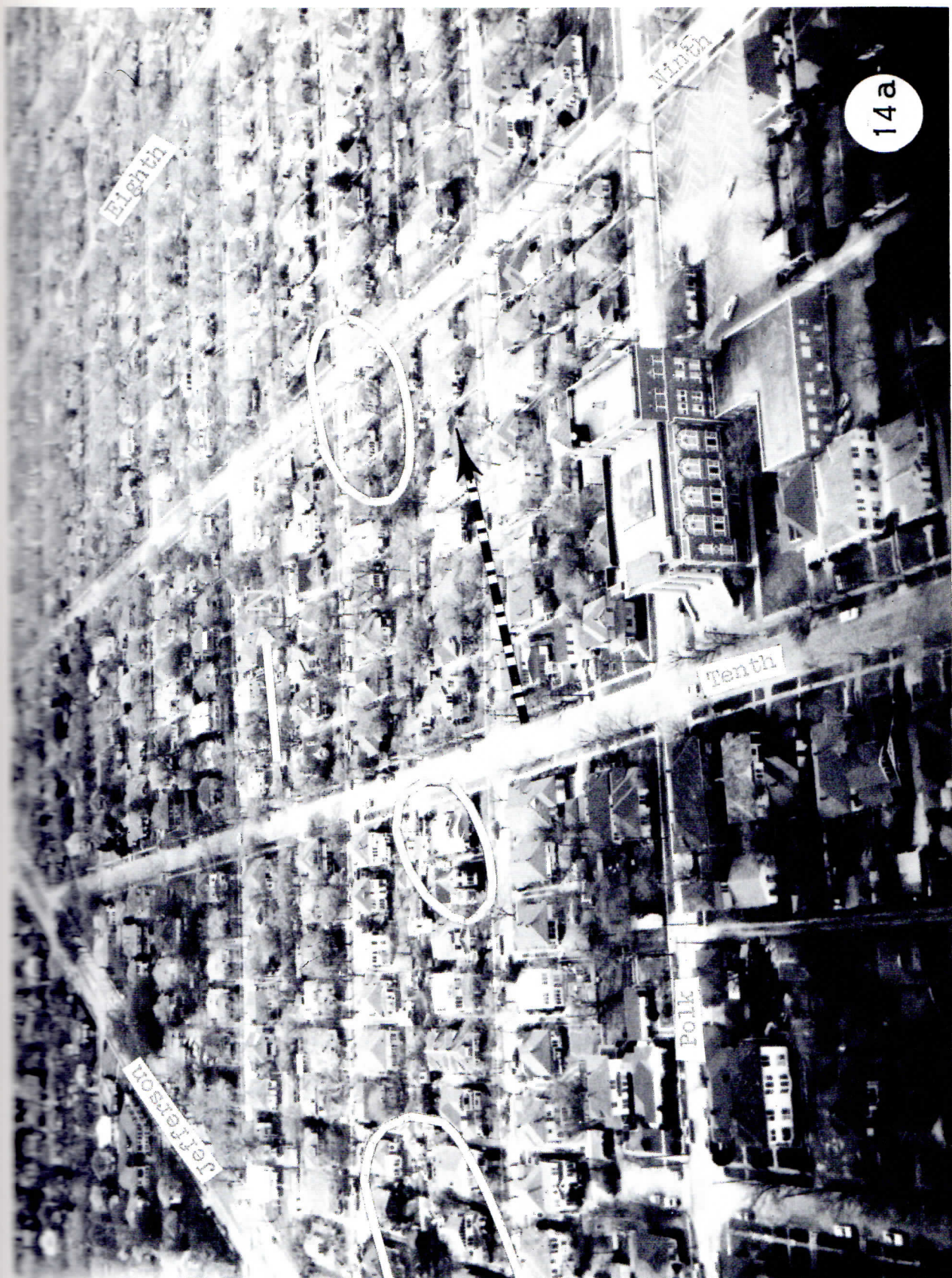

14a





15



15 a

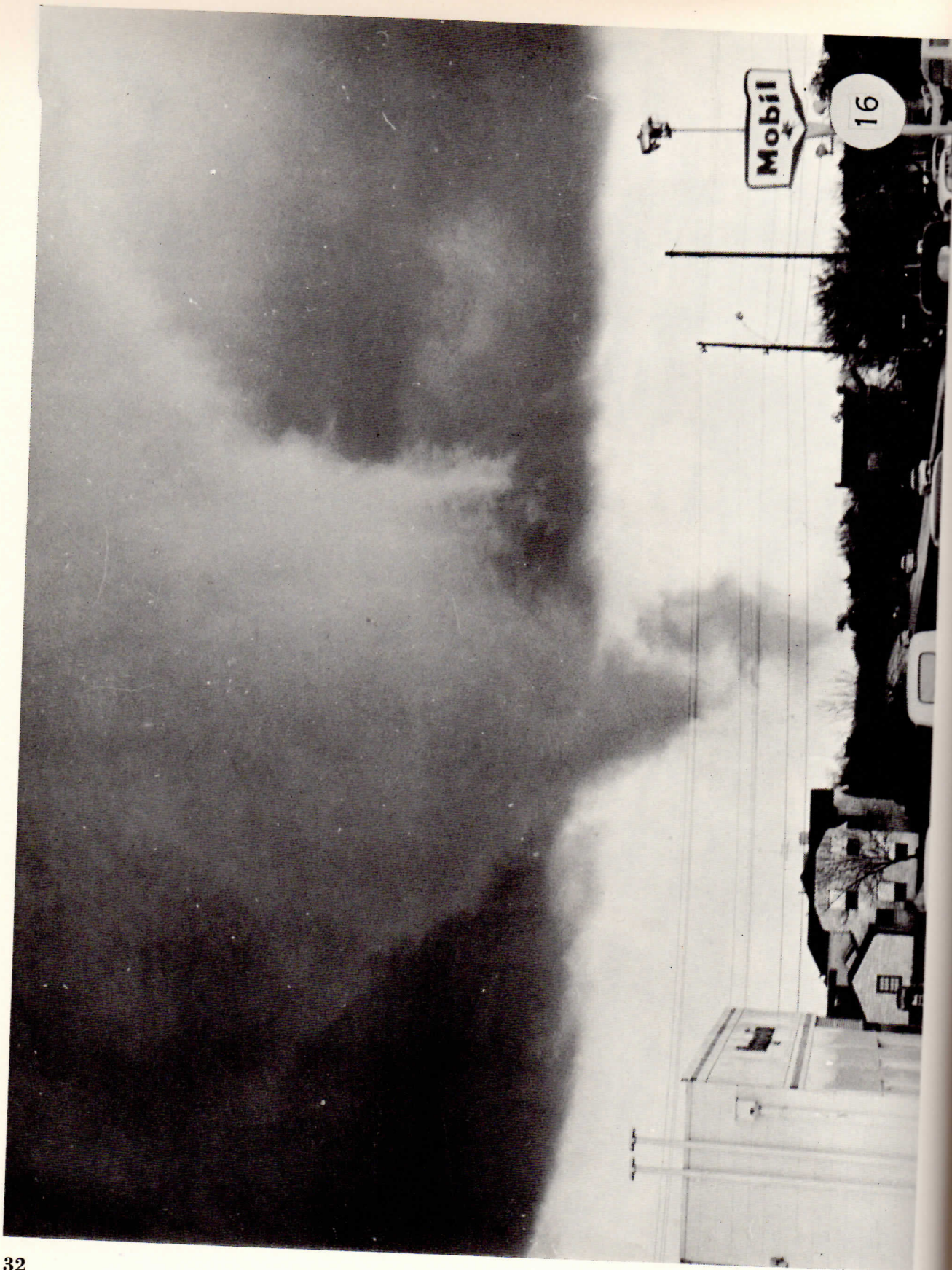



16

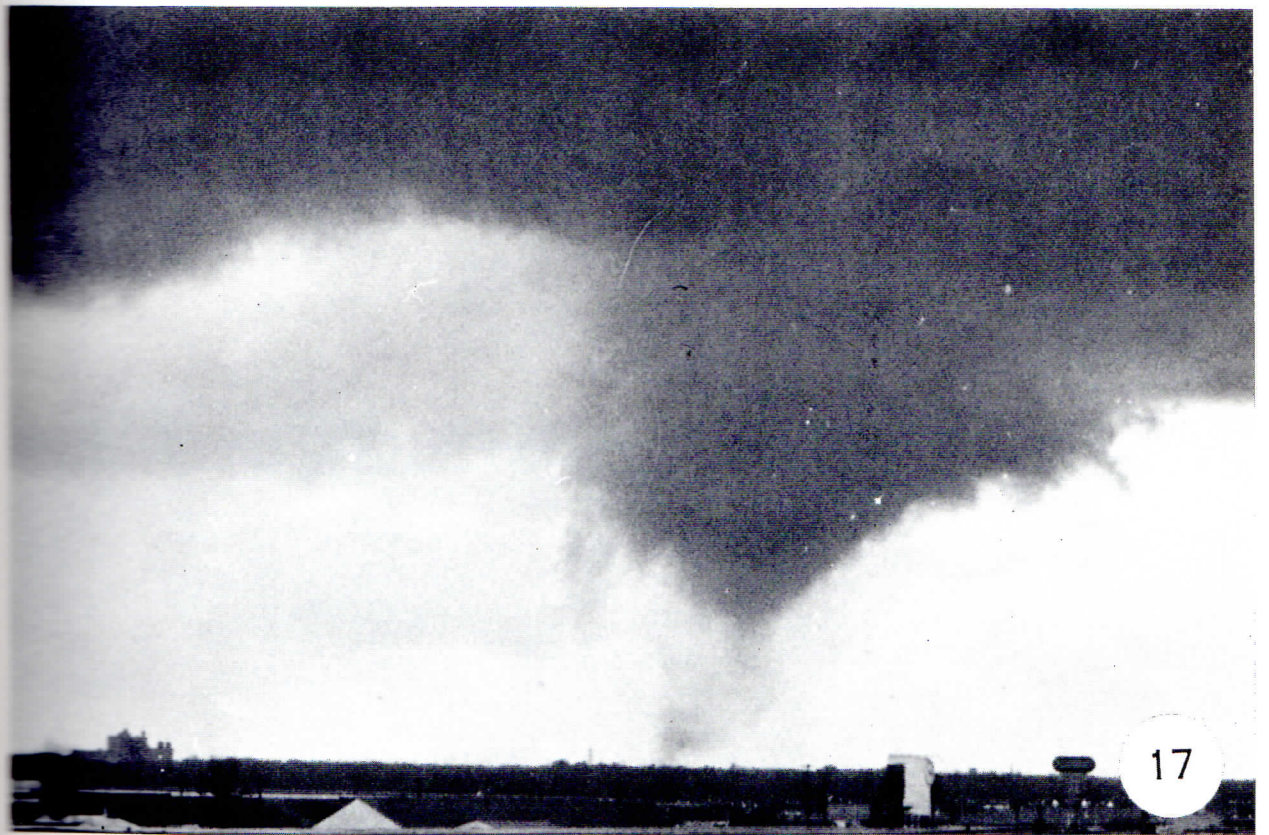





18



18a



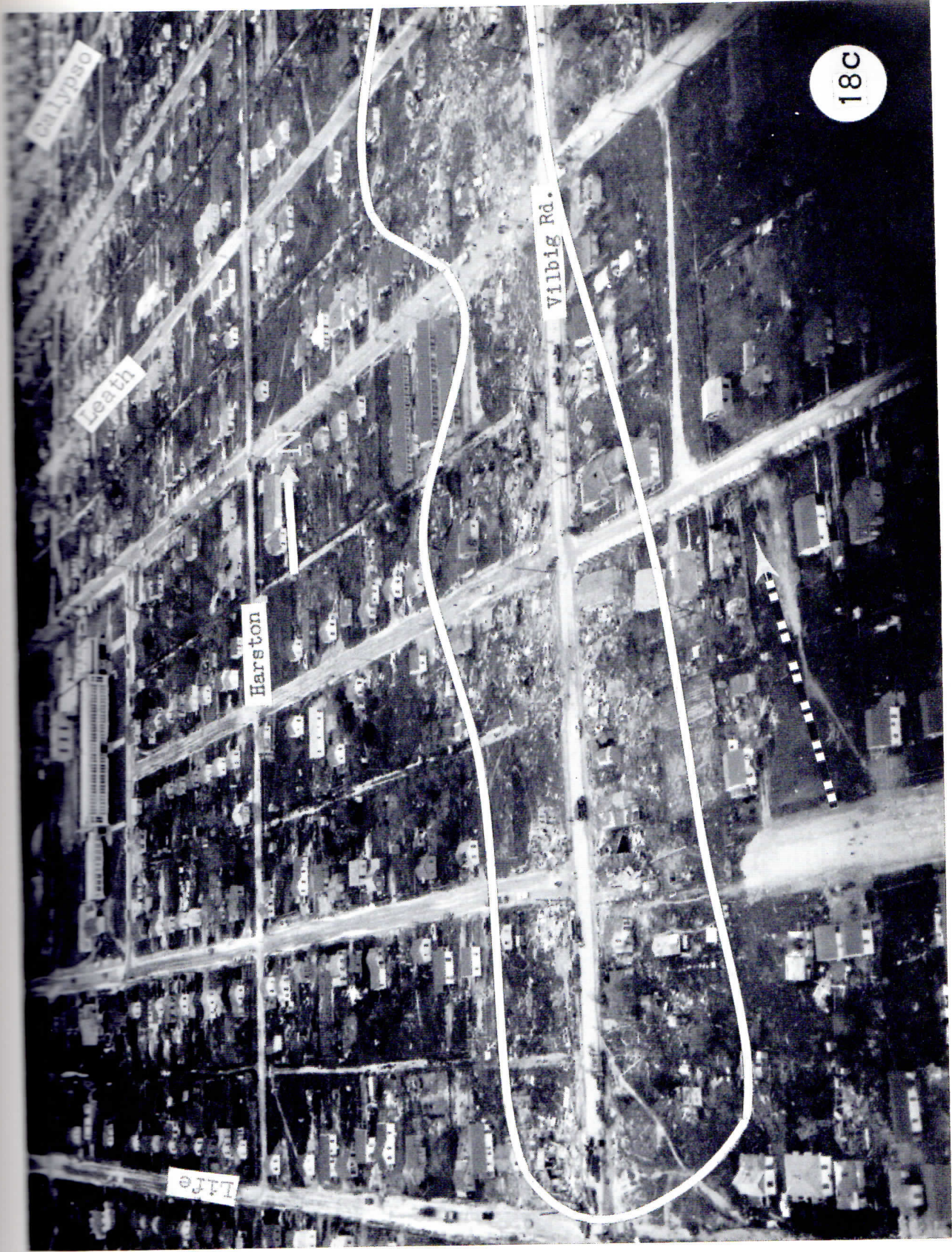
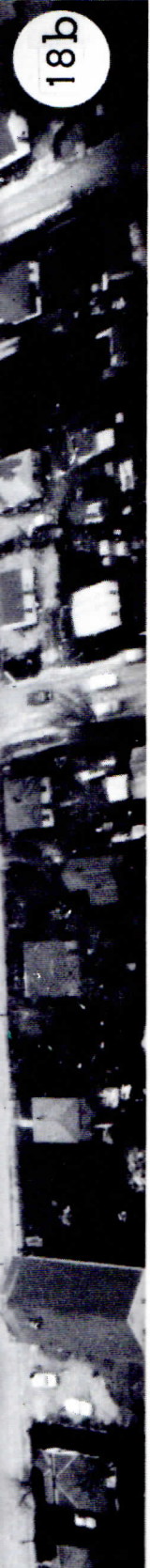



Levee

19



9





191b



20



21



21

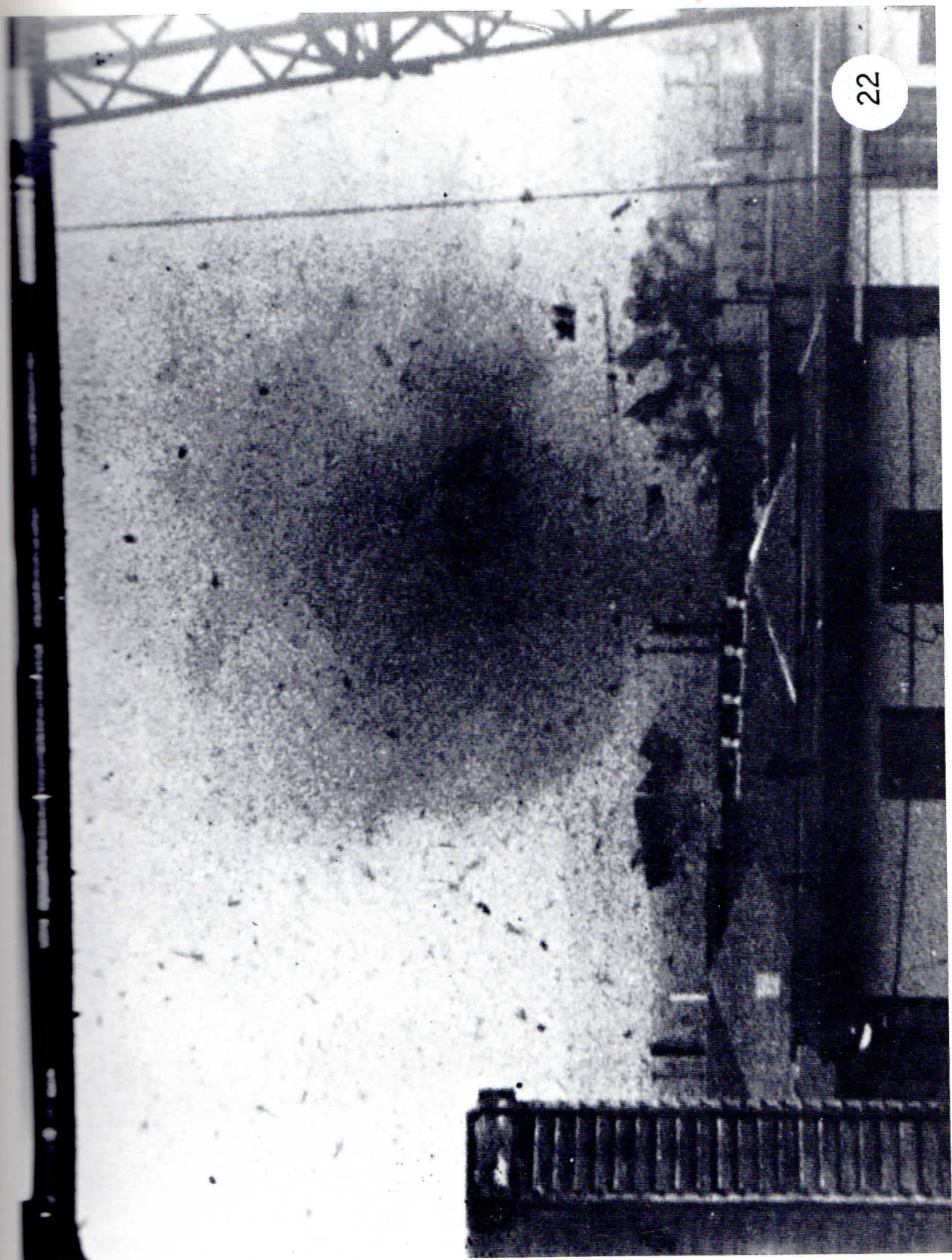

22





22a

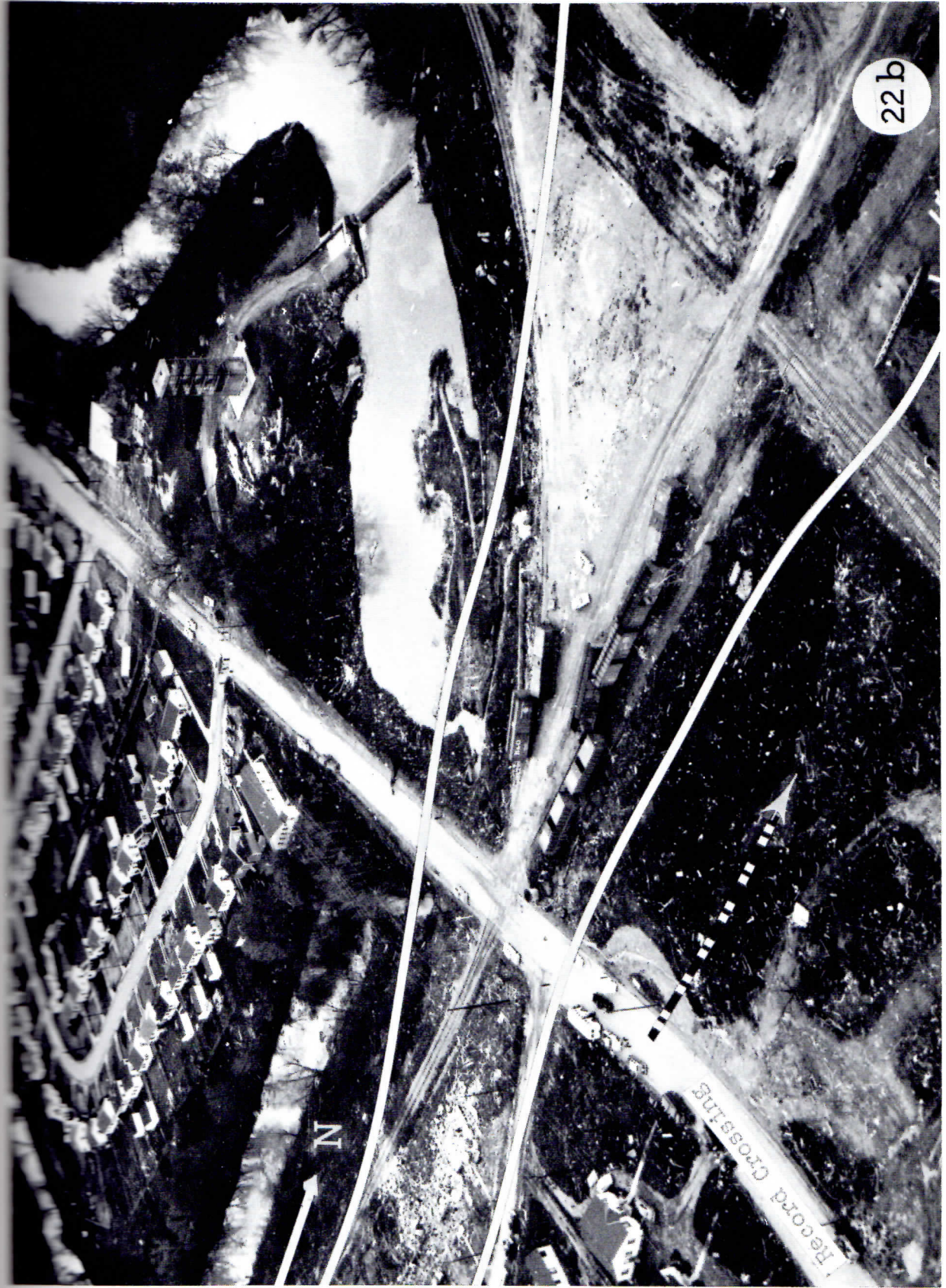

22b

N

Record Crossing

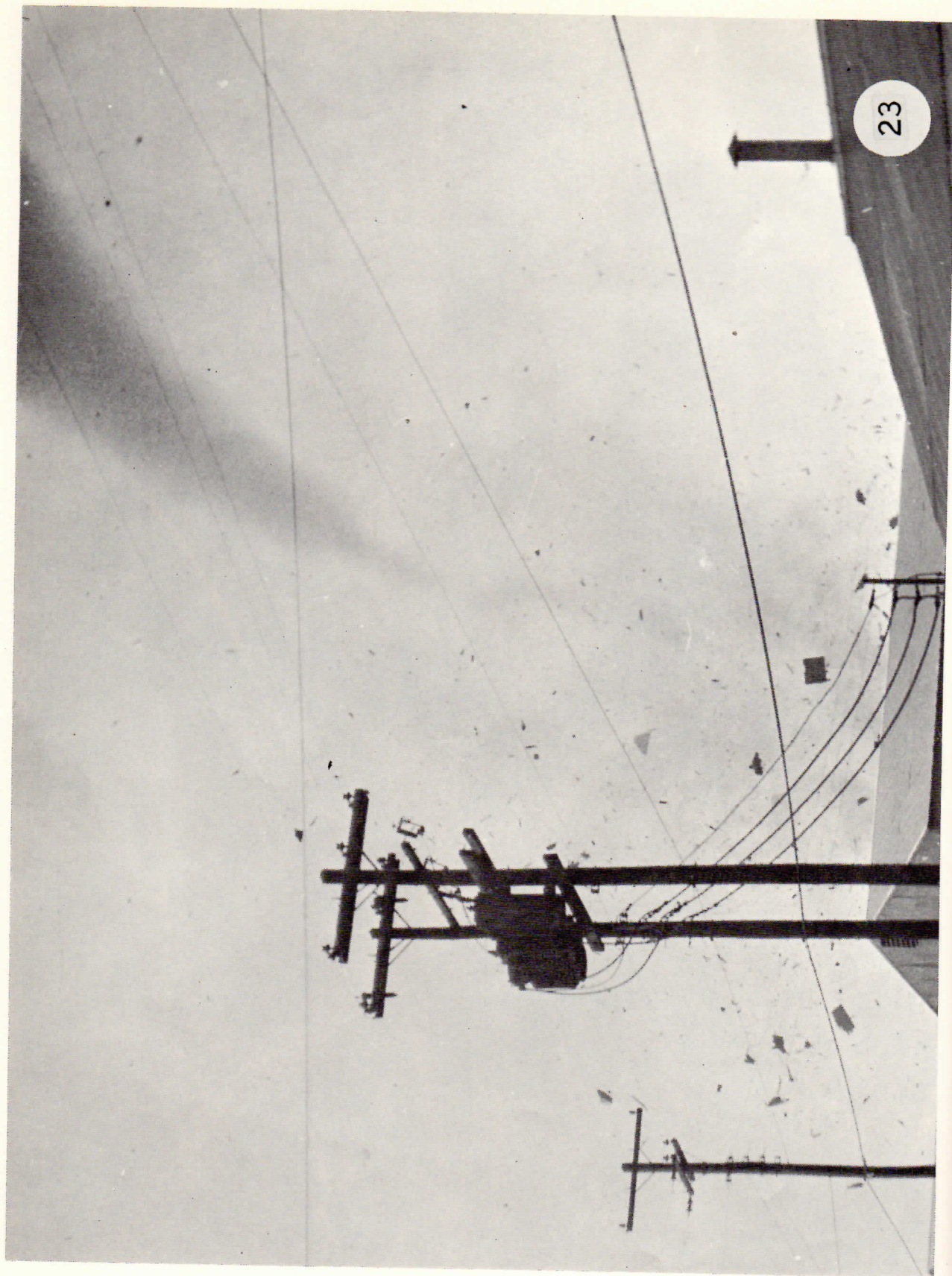

23



23 a





24



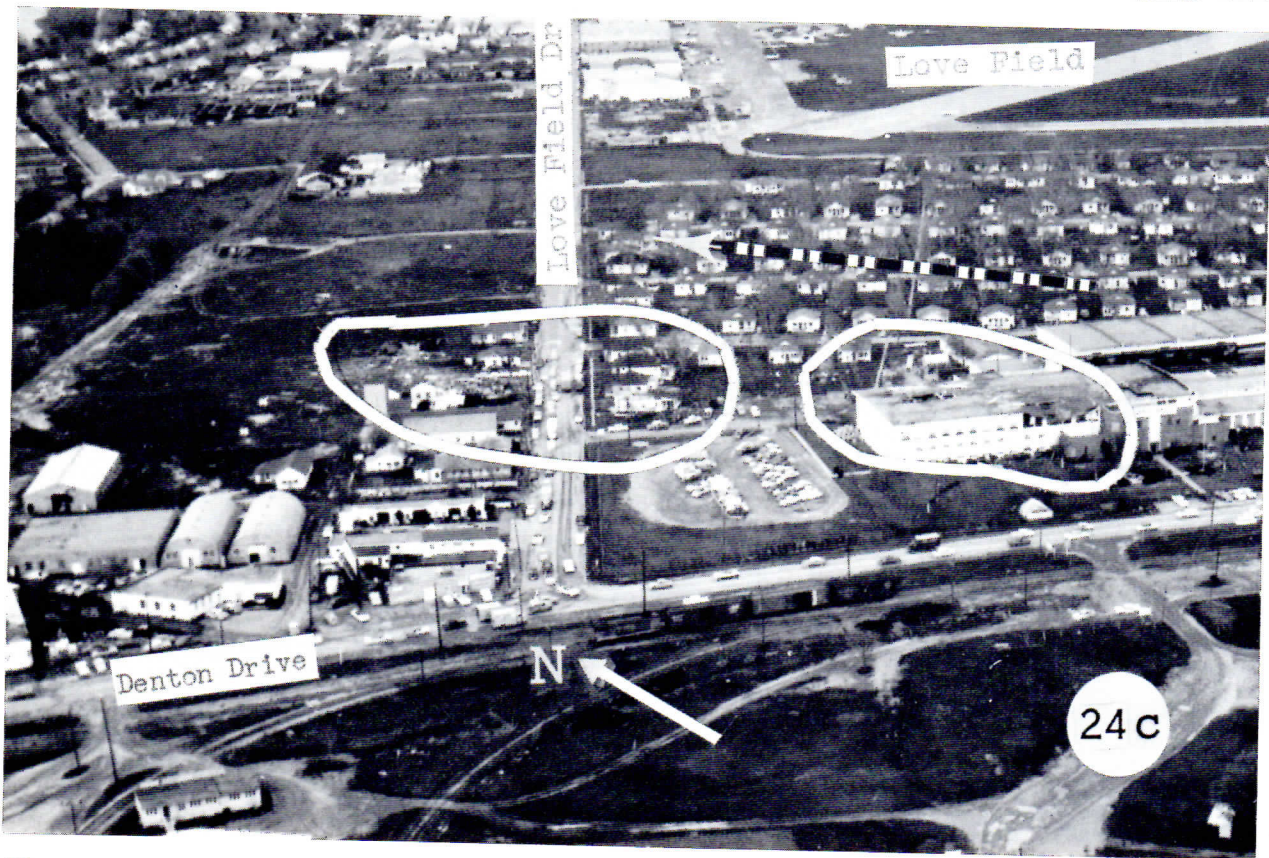
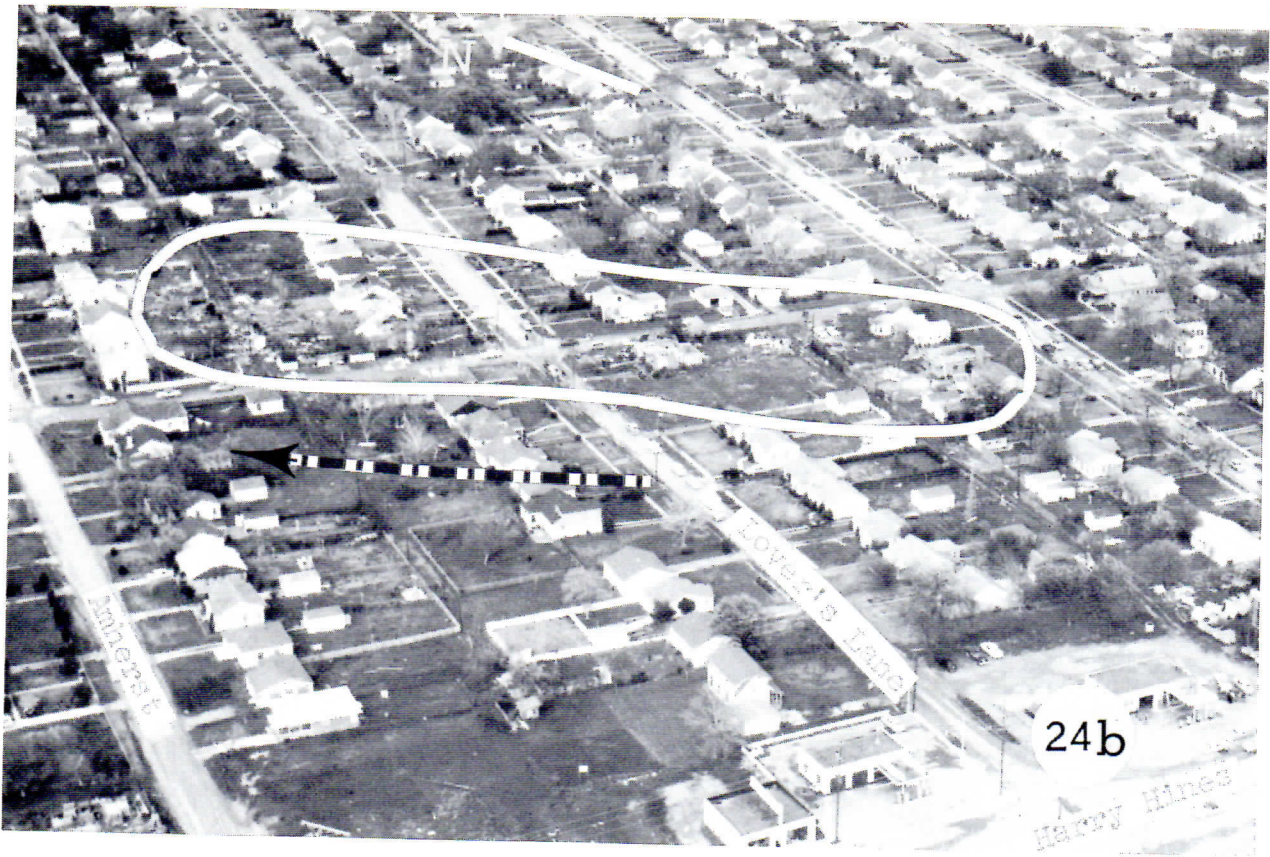

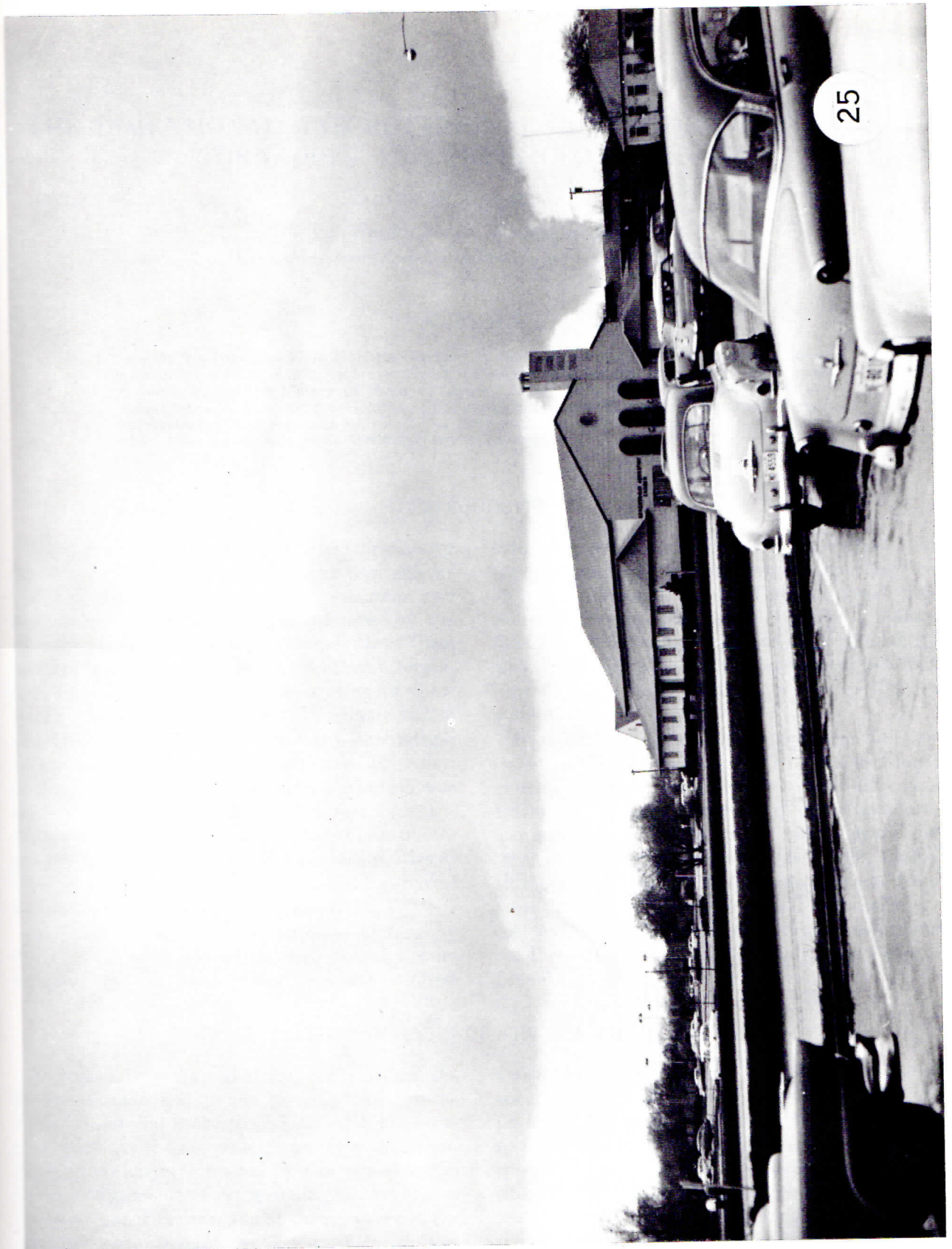

THE DIMENSIONAL AND ROTATIONAL CHARACTERISTICS OF THE TORNADOES AND THEIR CLOUD SYSTEM

WALTER H. HOECKER, JR.

U.S. Weather Bureau, Washington, D.C.

[Manuscript received November 14, 1958; revised September 21, 1959]

ABSTRACT

Scaled drawings made from photographs of the Dallas tornadoes and associated cloud system are used to obtain measurements of their size and shape and their minute-by-minute changes during the history of these tornadoes. Information on the wind field near the major tornado is provided by scaling of the movement of effluent from a fortunately placed smokestack. Measurements of rotational characteristics and convergence are also provided from the smoke-puff-derived tornado-wind vectors.

1. INTRODUCTION

During the time that the Dallas tornado of April 2, 1957, was moving along the west side of that city dozens of photographers, amateur and professional alike, were taking pictures of the tornado. Subsequently, several hundreds of these pictures were collected. Sufficient other information was obtained to allow the scaling of these pictures by photogrammetric [1] methods and to allow locating of the tornado for any photograph by use of the principles of perspective [2]. Out of these hundreds of photographs a selection was made that would allow the synthesis of a historical sequence of scaled photographs. These photographs have been converted into outline drawings, all reduced to the same scale, and significant measurements attached to the drawings.

The times of severance of major powerlines by the tornado as it moved through the city were recorded by the local power company. These

data provided a timetable of the tornado's passage and allowed a rather accurate determination of its translational speed. The additional data collected have made it possible to assign a definite time for each photograph used in this analysis series. Of necessity some interpolation between time fixes has been required but the results are quite consistent.

In the following section the significant dimensional and shape changes of the tornado funnel and its attendant debris cloud will be discussed. During the scaling process many of the measurements shown in the sketches were checked by other scaled photographs taken at or very nearly at the same time by other photographers from other locations. This was done to minimize errors in the scaling process as well as to determine the three-dimensional disposition of the tornado funnel.

2. QUANTITATIVE ANALYSIS OF THE SCALED PHOTOGRAPHS

Figure 1 is a map showing the path of the Dallas tornado and to the east the path of the funnel cloud that accompanied it. Along the tornado path are shown some of the main thoroughfares of the city intersected by the tornado. On the right-hand side of the tornado path are shown the locations of the tornado at the times when the pictures were taken corresponding to the 51

scaled sketches of figure 2. Each number corresponds to a sketch. On the left-hand side of the path are the minute-by-minute locations of the tornado as determined by the powerline severance times listed by Bigler [3]. From figure 1 the time of each sketch of figure 2 was determined to the nearest 0.1 minute. The same has been done for the funnel cloud sketches (fig. 3). However,

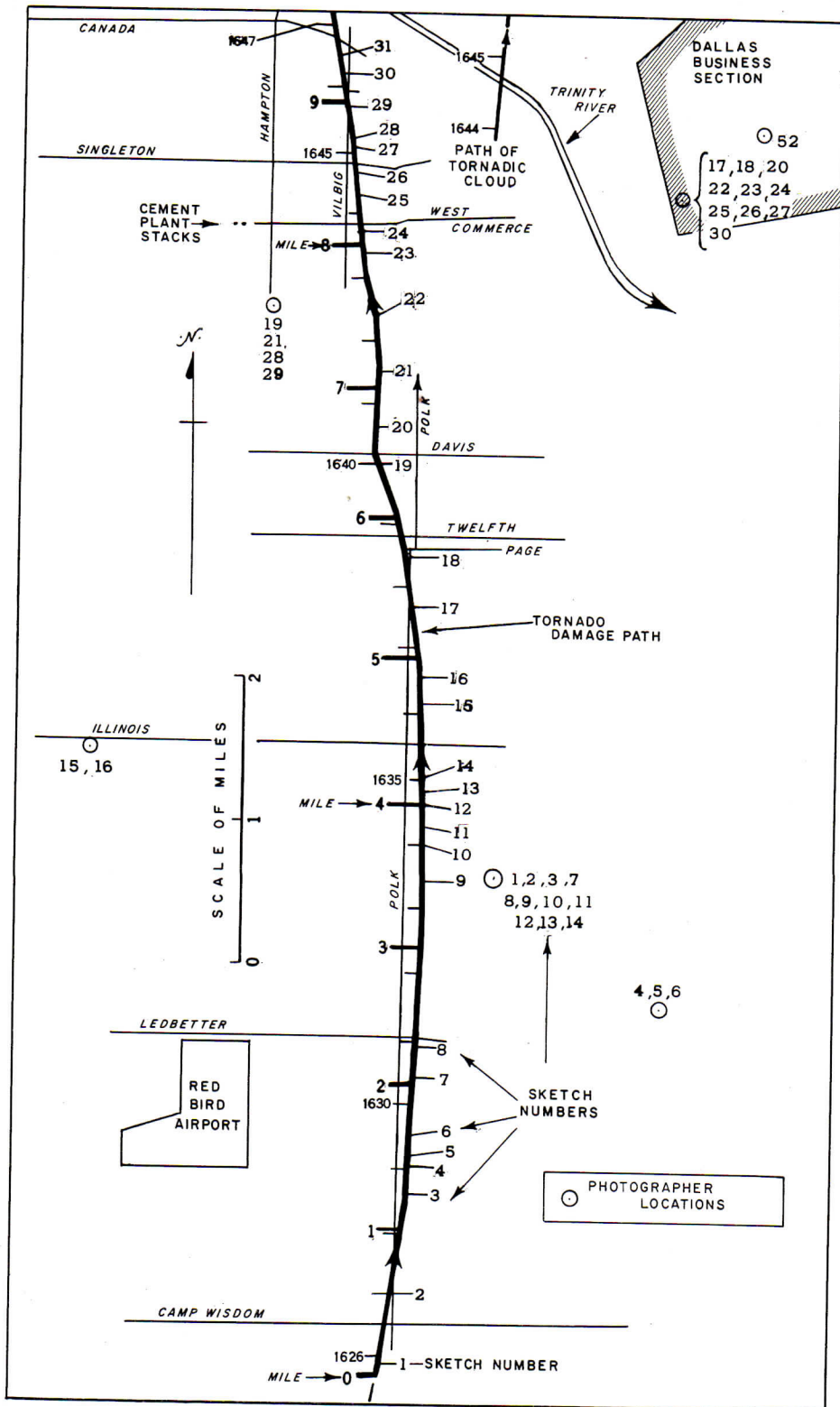

FIGURE 1.—South section.—Dallas tornado damage path and path of tornadic cloud. To the left of the damage path is marked the mileage along the damage path and the minute-by-minute locations of the tornado. To the right of the damage path are the locations of the tornado at the times of the numbered sketches of figure 2. The photographer-locations for the various sketches are shown by the circled dots.

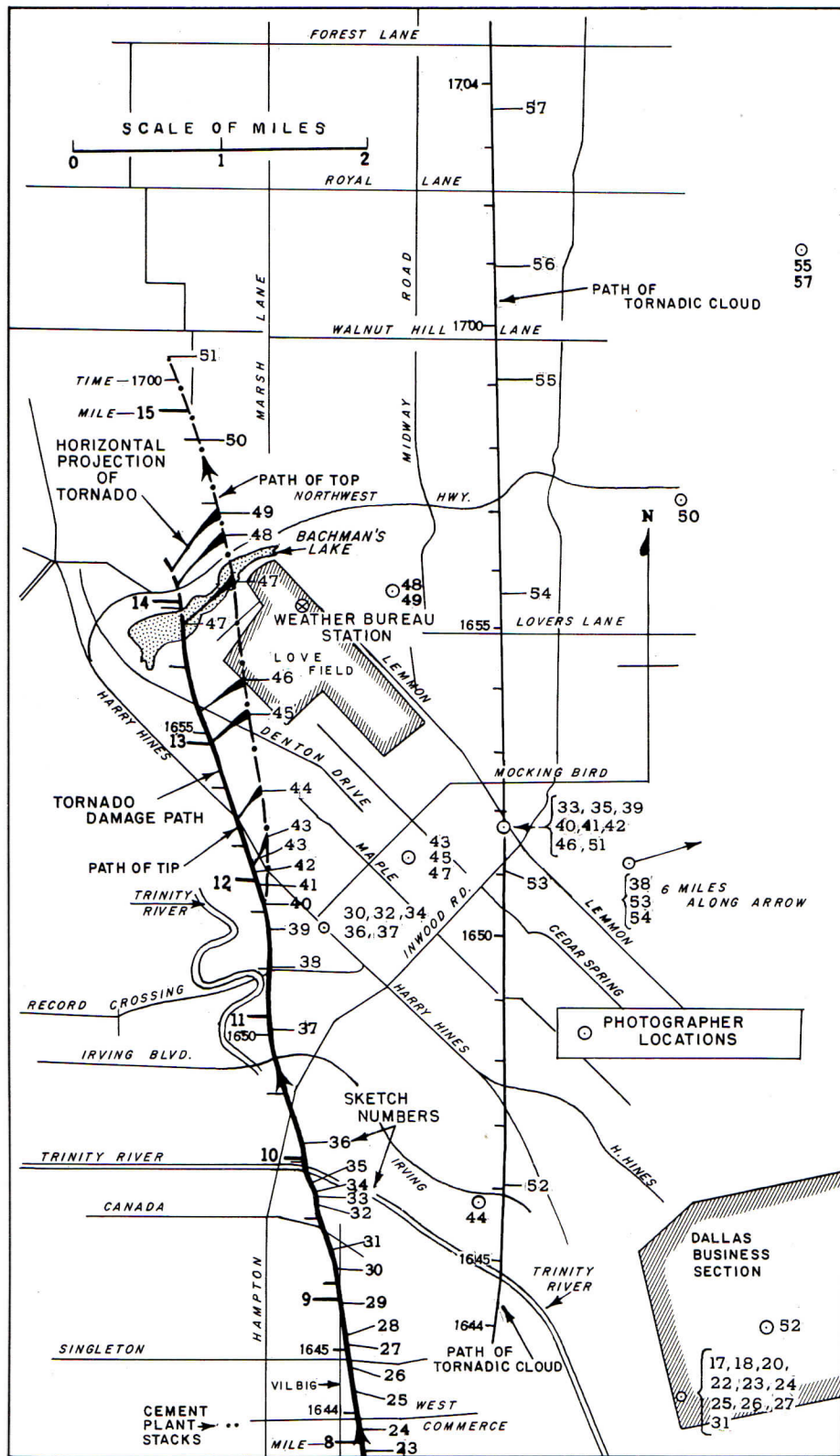

FIGURE 1.—North section.—Dallas tornado damage path and path of tornadic cloud. The same conventions apply to this section as to the south section. Just before mile 12, the tornado tip and top started to diverge in an east-west direction, the top followed the dash-dot path while the tip continued along the solid line.

since there was no ground intersection path for the latter, the sketch locations were determined from photographs showing both the tornado and the funnel cloud. Using cross-bearing views containing locatable landmarks the geographical location of the funnel cloud was obtained. Also shown are the 1-mile intervals along the paths. Observe that the paths of the tip and the top of the tornado began to diverge somewhere before the 12th mile.

The location from which any picture was taken, corresponding to a given sketch, can be found by matching a sketch number (along the right-hand side of the tornado path) with a number at one of the photographer locations shown on the map (fig. 1).

The direction from photographer to tornado is indicated by the arrow in the upper right-hand corner of each sketch of figure 2. The numbers just below the direction box show the time (csr) to tenths of a minute. Between each two sketches, at the lower border, is the time difference between adjacent sketches.

Table 1 lists the location-mile for each sketch, the time of the sketch, and the time interval between sketches.

The tornado moved generally south to north for nearly 16 miles along the west side of the city. The tornado covered this distance in a little over 34 minutes for an average speed of about 27 miles per hour. Details of the damage and eyewitness accounts relative to the actions of the tornado are described elsewhere [3, 4].

Sketch 1

The first photograph used in this analysis, taken at 1625.9 csr, seems to have been taken before a recognizable funnel formed and no funnel-like structure was visible in the picture. Only cloud shreds could be seen projecting downward from the wedgelike cloud structure that lay just below the main portion of the cloud. One wonders why the picture was taken since no particular tornado-shaped cloud had yet appeared. Evidently some unusual feature caused attention to be drawn to this cloud since another photographer was taking movies of it at nearly the same time. Fluctuations in density of the cloud projection along the lower boundary as shown by the movie suggested upward movement of air into the lowered portion of the cloud.

TABLE 1.—Time and location data for the sketches of fig. 2

Sketch No.	Location-mile	Central stand-ard time	Time lapse (min-utes)	Time difference (min-utes)	Sketch No.	Location-mile	Central stand-ard time	Time lapse (min-utes)	Time difference (min-utes)
1.....	0.10	1625.9	0.0		27.....	8.69	1645.0	19.1	.1
2.....	.65	1627.0	1.1	1.1	28.....	8.72	1645.1	19.2	.6
3.....	1.35	1628.8	2.9	1.8	29.....	8.92	1645.7	19.8	.5
4.....	1.45	1629.0	3.1	.2	30.....	9.20	1646.2	20.3	.3
5.....	1.52	1629.2	3.3	.2	31.....	9.32	1646.5	20.6	.7
6.....	1.66	1629.5	3.6	.3	32.....	9.63	1647.2	21.3	.1
7.....	2.05	1630.4	4.5	.9	33.....	9.70	1647.3	21.4	.1
8.....	2.30	1630.9	5.0	.5	34.....	9.73	1647.4	21.5	.2
9.....	3.45	1633.4	7.5	2.5	35.....	9.81	1647.6	21.7	.6
10.....	3.70	1634.0	8.1	.6	36.....	10.10	1648.2	22.3	1.8
11.....	3.82	1634.3	8.4	.3	37.....	10.90	1650.0	24.1	1.1
12.....	4.00	1634.6	8.7	.3	38.....	11.36	1651.1	25.2	.6
13.....	4.08	1634.8	8.9	.2	39.....	11.62	1651.7	25.8	.4
14.....	4.14	1635.0	9.1	.2	40.....	11.79	1652.1	26.2	.3
15.....	4.68	1636.2	10.3	1.2	41.....	11.91	1652.4	26.5	.2
16.....	4.87	1636.6	10.7	.4	42.....	12.03	1652.6	26.7	.2
17.....	5.36	1637.6	11.7	1.0	43.....	12.12	1652.8	26.9	.8
18.....	5.72	1638.5	12.6	.9	44.....	12.50	1653.6	27.7	1.1
19.....	6.43	1640.0	14.1	1.5	45.....	13.00	1654.7	28.8	.6
20.....	6.69	1640.6	14.7	.6	46.....	13.22	1655.3	29.4	1.4
21.....	7.10	1641.5	15.6	.9	47.....	13.81	1656.7	30.8	.6
22.....	7.50	1642.4	16.5	.9	48.....	14.10	1657.3	31.4	.3
23.....	7.90	1643.3	17.4	.9	49.....	14.20	1657.6	31.7	1.3
24.....	8.07	1643.7	17.8	.4	50.....	14.65	1658.9	33.0	1.3
25.....	8.35	1644.3	18.4	.6	51.....	15.10	1700.2	34.3	1.3
26.....	8.50	1644.7	18.8	.4					
				.3					

The shredded cloud elements were between 900 and 1,200 feet from the ground at the time (1625.9 csr) of sketch 1 (fig. 2) and the distance from the left side (east side) of the wedgelike structure to the right-hand side of the downward hanging cloud elements was about 4,100 feet. The general cloud base elevation was about 1,400 feet. The camera was pointed just a little to the west of south; this is indicated by the direction arrow in the upper right-hand side of the sketch box. At this position the tornado was 3.6 miles from the photographer and its location on the path was set as mile zero in figure 1.

The wedgelike element from which the cloud shreds depended shows more advantageously in another photograph taken from more than twice the distance as this one and from a point north-east of the tornado. In this latter photograph

Central stand- ard time	Time lapse (min- utes)	Time differ- ence (min- utes)
1645.0	19.1	.1
1645.1	19.2	.6
1645.7	19.8	.5
1646.2	20.3	.3
1646.5	20.6	.7
1647.2	21.3	.1
1647.3	21.4	.1
1647.4	21.5	.2
1647.6	21.7	.6
1648.2	22.3	1.8
1650.0	24.1	1.1
1651.1	25.2	.6
1651.7	25.8	.4
1652.1	26.2	.3
1652.4	26.5	.2
1652.6	26.7	.2
1652.8	26.9	.8
1653.6	27.7	1.1
1654.7	28.8	.6
1655.3	29.4	1.4
1656.7	30.8	.6
1657.3	31.4	.3
1657.6	31.7	1.3
1658.9	33.0	1.3
1700.2	34.3	

there appeared to be three wedges stacked one above the other, yet merged, where the end of each higher one extended farther southeast. From beneath the lowest wedge, and apparently north-west of its southeastern edge, descended the tornado. These stacked wedges resembled the stacked lenticular clouds sometimes seen over the Owens Valley in California.

Sketch 2

In sketch 2, 1.1 minutes later at 1627.0 csr, the tornado cloud had moved 0.5 mile closer to the photographer and a small funnel had projected downward about 450 feet below the cloud base to the right of it, or 900 feet below the cloud base to the left of it, and it was 700 feet from the ground. The wedge-shaped structure indicated in sketch 1 was still evident and the center of the funnel was about 2,800 feet west of the edge of it.

The funnel was 300 feet wide at the 1,100-foot level. Shredded cloud ends extended downward to the right of the funnel and a twisted-appearing cloud tag was just to the left of the funnel. The view was still just a little west of south since the tornado was moving nearly toward the photographer. The tip was rather diffuse in contrast to the sharply defined sides of the funnel higher up. This tip was the region where condensation was presumably taking place so the droplets would be smaller, and the smaller diameter of the tip allowed a shorter optical path length, hence the hazy appearance. The wedge-shaped structure from which the funnel was descending was presumed to extend toward the north (on the right-hand side of the sketch) rather than to the west which latter direction was its projected direction.

Sketch 3

In sketch 3 (equivalent to photo No. 1 in the section by Beebe) the tornado and accompanying clouds had moved closer to the photographer placing the tornado at mile 1.35 (see fig. 1). Here the funnel had descended to within 350 feet of the ground from 700 feet 1.8 minutes earlier in sketch 2. The portion below 850 feet in elevation had a considerable component toward the east showing a severe bend in the vortex. That portion was nearly transparent and it was accompanied by several cloud tags along its length. Small shredded cloud tags or cloud ends extended

downward from the main cloud just to the right (the west) of the tornado. Note that the break in profile between the upper right-hand side of the funnel and the main cloud, located by the arrow in sketch 3, was the same height as in sketch 2. In addition, the height of the cloud base to the left of the funnel in both sketches 2 and 3 was at nearly the same level, namely about 1,800 feet. The distance across the funnel cloud near 1,800 feet in elevation in sketch 3, where the funnel appeared to "break" with the parent cloud, was 3,000 feet, virtually three-fifths of a mile. The wedge-shaped cloud was still visible beneath the parent cloud.

Sketch 4

Two-tenths of a minute later, sketch 4 (1629.0 csr) shows the funnel somewhat broadened at the 480-foot level and above, with a 30- to 40-foot wide "stinger" that reached downward and most likely touched the ground. A house in the foreground hid that detail. Only the narrow lower portion and the lower right-hand side of the wider portion had any appreciable optical density. The remainder of the funnel was rather transparent. At 680 feet above the ground the nearly transparent funnel was 220 feet across. The time difference between these stages was short but the tornado shape and size did change considerably. The direction of view was to the southwest so that the tip, if in the plane of the photograph, would have been nearly 250 feet southeast of the main center. Note the size of the tornado compared to the square city block shown in this sketch.

Sketch 5

Sketch 5 shows changes even though it was only 0.2 minute after sketch 4. The long tubular tip had lagged to the southeast more than in sketch 4; it had been nearly 250 feet from beneath the center in No. 4 and at the time of sketch 5, was 500 feet to the southeast. If its true direction of lag was to the south the distance was even greater. The narrow tube was 40 to 50 feet in diameter, the midportion of the funnel reduced to 170 feet wide near the 650-foot level (it was 220 feet across in sketch 4) and the portion above that appeared to have narrowed a little. The level at which the funnel faired into the cloud was at 1,050 feet, as before. The cloud base to the left

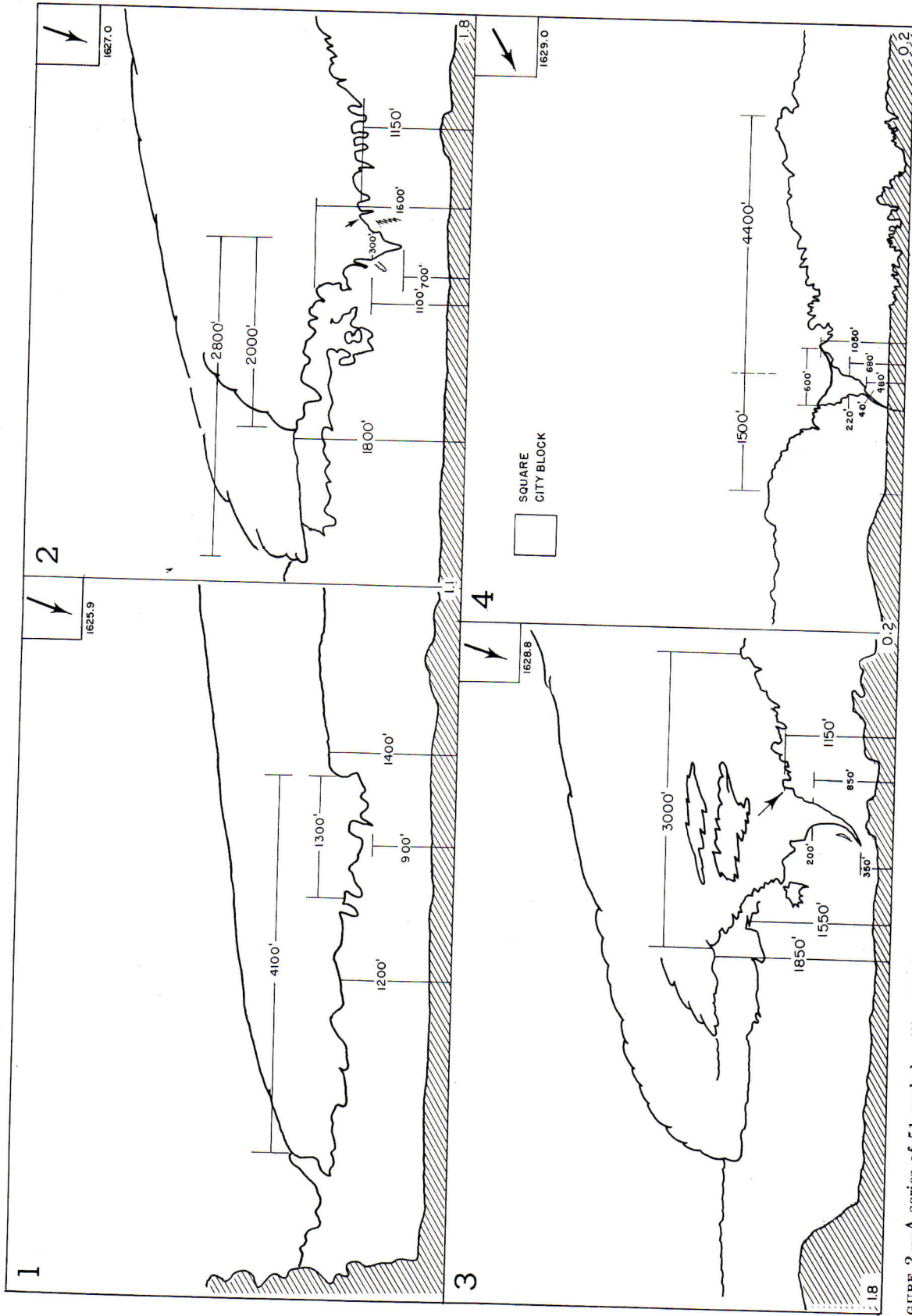

FIGURE 2.—A series of 51 scaled outline tracings from photographs of the Dallas, Tex., tornado of April 2, 1957. Scale for all drawings of figure 2 is identical. Arrow in upper right-hand corner of each sketch shows direction from photographer to tornado (e.g., SSW in sketch 1.); time (cst) of photo is just below arrow. Time (min.) between photos is near baseline in corners or between sketches. Sketches 1-4.—The wedge-shaped cloud from which the tornado extended is apparent. In the box of sketch 4 is drawn a square city block (one-twelfth mile) to scale for comparison with the size of the tornado.



FIGURE 2.—A series of 51 scaled outline tracings from photographs of the Dallas, Tex., tornado of April 2, 1957. Scale for all drawings of figure 2 is identical. Arrow in upper right-hand corner of each sketch shows direction from photographer to tornado (e.g., SSW in sketch 1.); time (cst) of photo is just below arrow. Time (min.) between photos is near baseline in corners or between sketches. Sketches 1-4.—The wedge-shaped cloud from which the tornado extended is apparent. In the box of sketch 4 is drawn a square city block (one-twelfth mile) to scale for comparison with the size of the tornado.

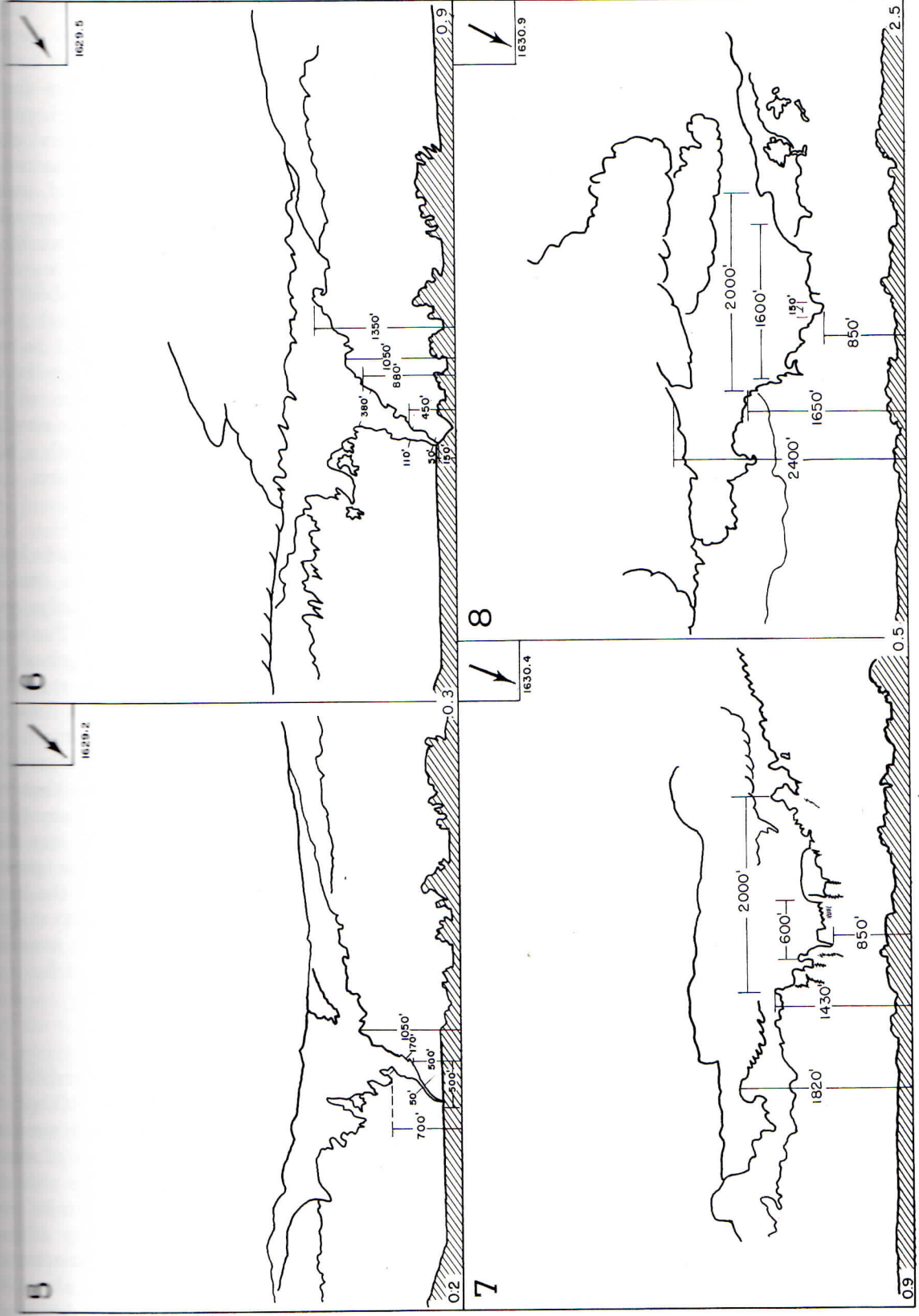

FIGURE 2.—Sketches 5-8.—Note the predominance of vertically aligned cloud tags under the bulging tornado cloud. At sketch 8, the tornado decreased its activity.

of the funnel (the southeast) was higher than to the right, as was the case before. At this stage the funnel above the narrow tube was getting ragged and patchy and did not at all present a smooth appearance. It appeared in the photograph more like the stack smoke from a locomotive. The direction to the tornado was to the southwest. Observe that in sketch 4 only the narrow tube slanted while the wide upper portion had a vertical axis; but in sketch 5, the midportion had become tilted. The tilted portion had moved upward from 480 feet above the ground to 700 feet. The greatest angle of tilt in sketch 5 was 50° from the vertical. Observe that with decreasing elevation from the level of maximum tilt the tube in both sketches 4 and 5 returned toward the vertical. This tendency for the portion of the funnel nearest the ground to be vertical has been observed in many tornado photographs.

Sketch 6

In sketch 6 (at 1629.5 CST) the funnel straightened although it slanted 25° from the vertical along its entire length. The lowest visible portion was 50 feet wide and it opened up to 380 feet in diameter at the 880-foot level, and at 450 feet above the ground its diameter was about 110 feet. The funnel had a ragged outline and its optical density was very nonhomogeneous; it was more or less transparent up to the 880-foot level. The projected ground intersection of the tip was about 440 feet southeast of the center of the top portion, the lag being only a little less than that in sketch 5. As before, the variable opacity of the funnel resembled the exhaust from a locomotive. The dust cloud, if any, was obscured by the foreground obstructions.

Sketch 7

Nine-tenths of a minute later at 1630.4 CST, the time of sketch 7, the tornado had moved so close to the photographer (1.5 mile) that the general cloud undersurface details could not be determined. (Sketch 7 is taken from photo No. 2 in the section by Beebe.) However, small details were easily seen in the photograph. Several events had taken place in the time lapse. The funnel had retracted, leaving a 2,000-foot-wide bulge of cloud which extended about 600 feet below the general cloud base at the center of the bulge. The vertically aligned cloud shreds ex-

tended downward another 100 feet to within 700 feet of the ground at the lowest. The wedge-shaped structure discussed earlier cannot be seen but other photographs, mentioned earlier but not used in this series, indicate that the wedge-shaped structure was maintained at least throughout this early period of the tornado. The general cloud base in the vicinity of the tornado remained at about 1,800 feet as before. The cloud undersurface was smoother toward the photographer and was torn-appearing only in the vicinity of the bulge. The direction of view was toward the south-southwest, and the bulge was about $1\frac{1}{2}$ miles away, whereas the distance to sketch 1 was over $3\frac{1}{2}$ miles. No cloud detail could be seen beyond the dark, low-level cloud bulge in the photograph due to the underexposure of the photographic print. Other photographs revealed that there were some low cumuli beneath a high altostratus layer to the west of this storm.

Sketch 8

In sketch 8, 0.5 minute later, the tornado bulge was only a little closer to the camera than in sketch 7. The lowest elements in the bulge were 850 feet from the ground at this time. The bulge was still 2,000 feet wide where it joined the parent cloud. The bottom was not as ragged as it was in sketch 7; however, various detached cloud shreds were in the vicinity to the right (the west-northwest). There was a suggestion of a funnel tip in the center of the bulge that was 150 feet wide, but it was rather transparent and indefinite in the photograph. There was difficulty in determining the level of the general cloud base, but there was a break in the bulge curvature on the left side (east-southeast) at 1,650 feet above the ground. The bulge was smoother and more rounded than in the last sketch.

Sketch 9

Apparently there was not much activity beneath the cloud bulge since the photographer allowed 2.5 minutes to elapse between taking the pictures from which sketches 8 and 9 were extracted. The tornado cloud at the time of sketch 9 (1633.4 CST) was only 0.6 mile away with the result that again only the closeup details were visible. There were various vertically aligned cloud tags in the area to which the cameraman's attention was drawn. A small bulge about 600 feet wide was shown which reached downward

to about
from the
high. 7
(south)
about 50
enough
small vo
the time
section v
view was
nado wa

Sketch 1
By the
re-formi
and the
(Identica
All the
peared a
was abo
its paren
the surf
ground a
the funne
appearin
doubtedl
ground b
dant clo
(slightly
was soli
looking
it was m
This pen
pearance
shredded
appeared
mile or t
from sev
around i
shaped p
of the to

Sketch 1
By the
the torna
trees. ('
section b
the funne
which wa
the tip, a
Note the
ing like

to within 700
The wedge-
cannot be seen
earlier but not
wedge-shaped
throughout this
general cloud
remained at
cloud under-
photographer
the vicinity of
as toward the
as about 1 1/2
sketch 1 was
could be seen
bulge in the
obscure of the
graphs revealed
beneath a high
storm.

tornado bulge
nera than in
e bulge were
e. The bulge
t joined the
as ragged as
ous detached
he right (the
gestion of a
dge that was
nsparent and
re was diffi-
the general
in the bulge
east) at 1,650
was smoother
sketch.

activity be-
ographer al-
a taking the
l 9 were es-
me of sketch
ay with the
details were
ally aligned
cameraman's
re about 600
l downward

about 850 feet from the ground, and protruded from the cloud base which was about 1,250 feet high. The sharply tipped cloud tag to its left (south) was 150 feet across at the top and was about 500 feet long. The picture was not clear enough to determine whether or not this was a small vortex, but it did resemble one. The view at the time was to the west. Photo No. 3 in Beebe's section was taken at nearly the same time but the view was toward the south-southwest and the tornado was 8 miles away.

Sketch 10

By the time of sketch 10, 0.6 minute later, the re-forming funnel was still about 0.6 mile away, and the view had changed to the west-northwest. (Identical to photo No. 5 in the section by Beebe.) All the torn-appearing cloud tags had disappeared and the funnel was again organized. It was about 1,700 feet across where it faired into its parent cloud and extended to 1,600 feet above the surface. The tip was 670 feet from the ground and was 90 feet across. The surface of the funnel was smooth in contrast to the ragged-appearing bulge of the last three sketches. Undoubtedly there was already a dust cloud at the ground but it was hidden by the trees. The pendant cloud, located to the west of the funnel (slightly to the left in this sketch at the arrow) was solid-appearing and other pictures taken looking north toward the tornado revealed that it was more than 1,000 feet west of the funnel. This pendant cloud did not have the smooth appearance of the funnel but it had the vertically striated or striated appearance on its edges. It appeared to move along with the funnel for a mile or two and appeared, from evidence obtained from several photographs, to be rotating slowly around it. The volume occupied by the funnel-shaped pendant cloud apparently exceeded that of the tornado itself for the next few minutes.

Sketch 11

By the position of sketch 11 (at 1634.3 csr) the tornado had moved away from the obscuring trees. (This is identical to photo No. 6 in the section by Beebe.) Here the angle subtended by the funnel had considerably narrowed. That part which was visible extended upward 530 feet from the tip, and the tip was 620 feet from the ground. Note the small dust cloud at the ground appearing like a spinning top, that was only 90 feet

high, yet four times taller than the average house, and 50 feet wide and tapered to a point at the ground. The vertical distance from the top of the dust cloud to the tip of the tornado was 530 feet. The pendant cloud mentioned in the last sketch appeared farther away to the west of the tornado. Since the camera angle had changed little, the pendant may have rotated a short distance around the tornado. The direction of view was toward the northwest and the time lapse since sketch 10 was 0.3 minute. Stratus and bulging cumulus clouds could be seen in the distance beyond the area of the tornado parent cloud. Some cloud tags could be seen to the left of the funnel, and in front of the pendant cloud.

Sketch 12

In Sketch 12 (at 1634.6 csr, and identical to photo No. 7 in section by Beebe) the funnel had narrowed even more in the lower half of the visible portion; the tip had not lowered but remained 600 feet above the ground. The funnel was visible in the photo up to 1,350 feet in elevation, 200 feet more than in the prior sketch. For the first time a dwelling in the process of disintegration was photographed and pieces hurled as high as 200 feet above the ground are shown in the sketch. Some of the pieces were 20 to 30 feet across and according to Beebe were sections of roof. The dust cloud was rather unsymmetrical and extended upward toward the tip for a distance of 250 feet. Its horizontal projection was 160 feet. The blunt tip of the funnel was 40 feet across and was rather transparent, as it was in earlier sketches. The pendant cloud (to the left of the tornado), seen earlier in sketches 10 and 11, was more clearly seen here (located by the arrow). Since there was little difference between the direction toward the tornado in sketches 11 and 12, the pendant cloud, which appears farther to the left, may have moved somewhat around the tornado cyclonically with the outer or peripheral circulation. (Actually there was another cloud pendant in front of the one under discussion that was visible in sketches 11, 12, and 13 and it was probably moving around also.) The time of this sketch was 0.3 minute after sketch 11, and the tornado was 4 miles from the location at sketch 1.

Sketch 13

In sketch 13 at 1634.8 csr, 0.2 minute after the last drawing, the lower funnel changed from its

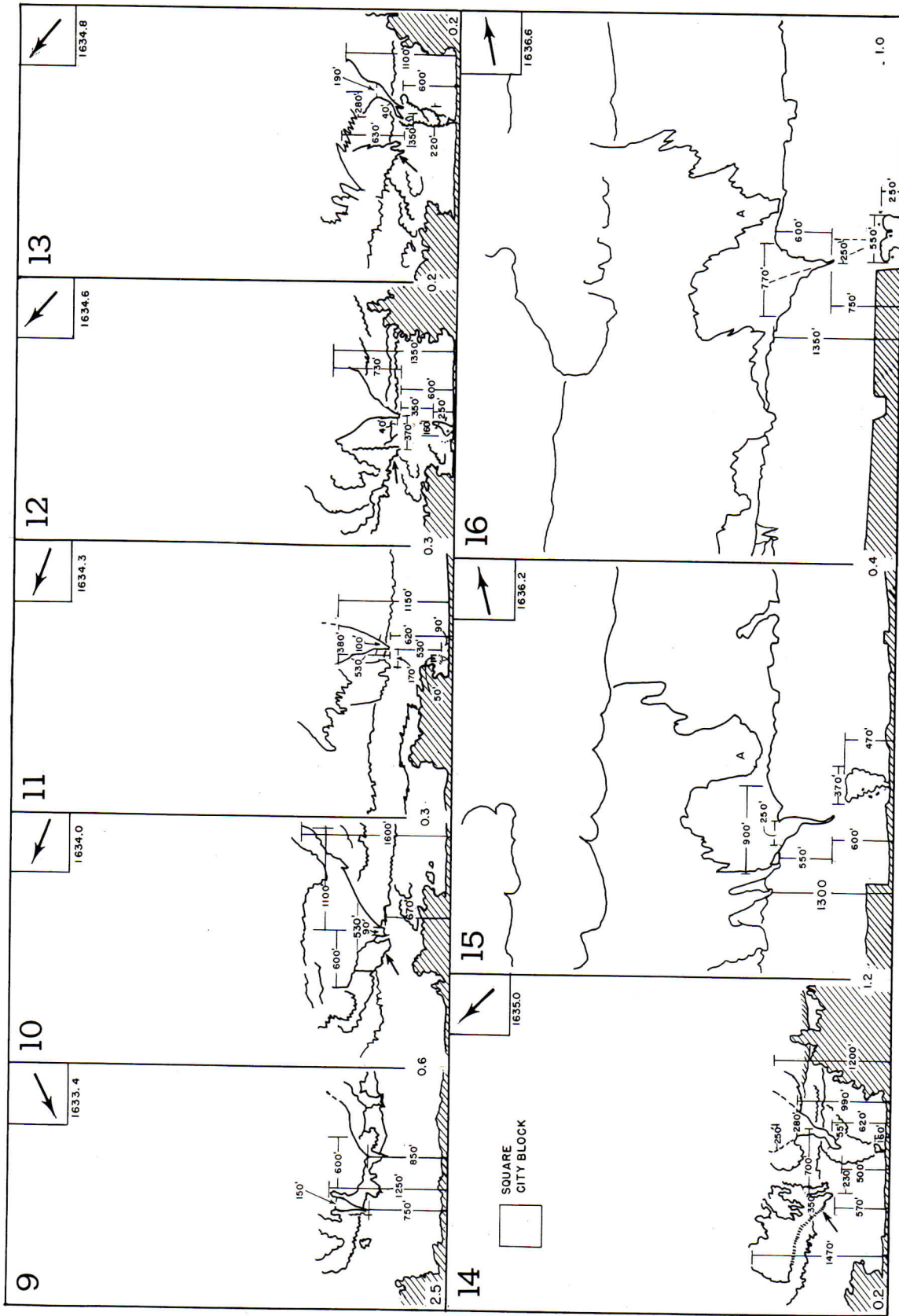

FIGURE 2.—Sketches 9—16.—At the stage of sketch 10 the tornado became reactivated. A square city block, drawn to scale (one-twelfth mile), has been placed in sketch 14 for comparison with the size of the tornado.

vertical
the rede
a spirali
high torn
tip appe
ground b
by about
funnel ex
the paren
across at
40 feet a
photograp
existed.
was more
cloud. N
to the left
center of
dust or de
many pie
the dust,
Presumab
the momen
The prom
still visibl
what larg
was an in
did not h
tornado w
elapsed si
smaller ra
the afore
two previ

Sketch 14

In sket
the north
the last sh
rowed to 2
tip had le
More of t
and a par
At the 62
diameter.
surface wa
only abou
height of
watching r
newly stir
ments mov
turbulenc
remainder
density (b

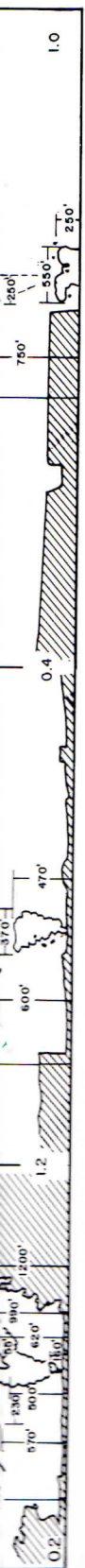

FIGURE 2.—Sketches 9-16.—At the stage of sketch 10 the tornado became reactivated. A square city block, drawn to scale (one-twelfth mile), has been placed in sketch 14 for comparison with the size of the tornado.

vertical attitude which it had maintained since the redevelopment following sketch 9. There was a spiraling dust cloud connecting the 600-foot-high tornado tip with the ground; the dust cloud tip appeared to be about 20 feet across near the ground but rapidly expanded to 220 feet across by about 270 feet in elevation. The condensation funnel extended about 630 feet downward from the parent cloud base and narrowed from 190 feet across at the lowest end of the vertical portion to 55 feet across near the tip. The double tip was photographed by several cameras so it actually existed. The diameter of the top of the funnel was more than 550 feet where it joined the parent cloud. Note that the tip of the tornado extended to the left (to the southwest) 280 feet from the center of the vertical portion of the funnel. The dust or debris cloud was of low optical density, but many pieces of timber were falling in and around the dust cloud, some from as high as 450 feet. Presumably no buildings were being wrecked at the moment, since no large chunks were visible. The prominent pendant cloud (at the arrow) was still visible and at this point appeared to be somewhat larger than the tornado. Whether or not it was an incipient funnel is not determinable, but it did not have the smooth appearance of the usual tornado vortex. Eight-tenths of a minute had elapsed since it was first exhibited here. Another smaller ragged pendant cloud was still in front of the aforementioned pendant as it had been in the two previous sketches.

Sketch 14

In sketch 14, 0.2 minute later (and still toward the northwest, but a little more northerly than the last sketch), the top of the funnel had narrowed to 280 feet at 990 feet in elevation, and the tip had lowered to 500 feet above the ground. None of the funnel was slanted at this instance and a part of the tip tilted rather pronouncedly. At the 620-foot level the funnel was 55 feet in diameter. The tapered dust cloud nearest the surface was optically dense. At the ground it was only about 20 feet wide and it extended to a height of 160 feet. It is believed, as a result of watching movies of this tornado, that this was a newly stirred up dust or debris cloud. As its elements moved upward they would be diluted by turbulence into a cloud of low optical density (but had a definite border) and was rep-

resented by the scalloped outline which extended from the top of the more dense cloud to the tornado parent cloud base. The height of the funnel was difficult to determine but possibly was in the vicinity of 1,200 feet. The prominent pendant cloud, located by the arrow, remained to the left (to the southwest) of the funnel and its center was at least 900 feet from the center of the tornado. The double tip of the pendant cloud shown in the prior sketch remained here. The bottom of the tornado tip was offset 250 feet from the center of the top portion of the funnel. Here the view was toward the northwest. Note the square city block drawn to the same scale as the tornado.

Whether or not these cloud pendants were rotating around the tornado was not easy to determine from the photographs. Movies taken at a later stage show similar pendants and smaller cloud tags actually moving around the tornado. It is possible that some of these smaller pendants were the equivalent of the peripheral clouds that were so prominent in the second Scottsbluff tornado [5]. They were much more continuous, like a cylindrical sheet, in the Scottsbluff case, however.

The tornado at this stage was less than 0.1 mile south of its position at the time of picture No. 8 in the section by Beebe. But the direction to the tornado in sketch 14 was toward the northwest and in photo No. 8 was toward the south-southwest. The darker, knoblike affair on the tip of the tornado in photo No. 8 (Beebe) is a result of the view along the highly tilted portion of the funnel tip at the 620-foot elevation in sketch 14.

Sketch 15

With sketch 15 (1636.2 cstr) the view shifted toward the east, and the photographer was 2.3 miles from the tornado. It was observed in the sketches previous to this that even though the view varied nearly continuously from a direction toward south through northwest, there was lighter shaded sky beyond the dark cloud immediately associated with the tornado. Now with the shift of view toward the east, light-shaded sky east of the funnel was visible in this photograph also. This suggests that the storm cloud containing this tornado was circular in horizontal projection, or perhaps elliptical and elongated in a north-south direction. This effect of lighter shading beyond the tornado has been noted in many other tornado photographs. The writer has seen a few photo-

graphs in which the dark cloud base beyond the tornado appeared to merge with the horizon in which case the funnel appeared white or light gray against the dark background.

In the photo for this sketch, it was difficult to determine where the funnel faired into the cloud base, but contrast between the funnel and apparent cloud base ended at 1,300 feet above the surface. The funnel bulge appeared to be about 900 feet in diameter at the cloud base, but narrowed to 250 feet at a slightly lower elevation which was 550 feet above the tip. The tip itself was about 600 feet above the ground and was quite sharply pointed. Note that the tip pointed toward the left (north) edge of the conical dust cloud. Here again the dust or debris cloud resembled a spinning top as it did in sketch 11. The dust cloud had moderate optical density and a few pieces of shattered structure could be seen near it. It was 470 feet high and 370 feet wide at its top. Pendant clouds were visible between the funnel and the photographer; the one shown at "A" most likely was not the same one that has been described in several prior sketches. This view was 1.2 minutes after sketch 14. The tornado position for sketch 15 was 0.2 mile north of the location for photos Nos. 9 and 10 in the section by Beebe.

Sketch 16

In sketch 16, the funnel became symmetrical although it had a slight slant of 20° from the vertical to the left (north, since the view was essentially to the east). The tip lifted to an elevation of 750 feet above the surface and was quite sharp. At the apparent cloud base at an elevation of about 1,350 feet, the funnel was 770 feet wide. The dust cloud was only 250 feet high but had widened to 550 feet and a few pieces of debris were visible in it. Numerous ragged or shredded cloud pendants were visible between the funnel and the photographer and, judging from the appearance of the lightly shaded cumulus clouds above the funnel in the picture, the photographer location was near the western edge of the tornado parent cloud at a distance of 2.3 miles from the funnel. It is presumed that the pendant labeled "A" is the same one labeled "A" in sketch 15.

Photo No. 11 in the section by Beebe was halfway between sketches 16 and 17. There is considerable shape resemblance between photo No. 11 and sketch 17. The curved tip appearing in sketch

17 disappears in the view of photo No. 11 because the latter view is nearly 90° in direction away from sketch 17.

Sketch 17

One minute later, the view shifted in sketch 17 to the south-southwest (time 1637.6 CST). The straightening out of the funnel in the last sketch must have been a preliminary to increased length¹ and width since in this drawing the tip had lowered nearly to the ground (only 160 feet above it). A small dust cloud, just 160 feet high, accompanied this lowered tip and it appeared to lead the tip a little. This tip exhibited the kinked characteristic shown in earlier sketches (see 13 and 15, for example), but here the kink was much closer to the ground. The tip was pointed with a component toward the east-southeast at the time of this sketch and it was at least 520 feet from beneath the center of the upper portion of the tornado. The trunk was 140 feet wide at the 770-foot level and 850 feet wide at the elevation where it faired into the 1,350-foot-high cloud base, being a little wider than in sketch 16 at the same level. Vertically shredded cloud tags were prominent to the right of the funnel (generally to the northwest). The smallness of the dust cloud may have been due to the underexposed pictures from which this sketch was taken. At this stage the funnel almost assumed the often-observed elephant-trunk shape.

Sketch 18

Although the picture from which sketch 18 (1638.5 CST) was extracted, was taken only 0.9 minute after that of sketch 17, the funnel had changed shape and dimensions considerably. The funnel as a whole became straight, and assumed a tilt of 30° from the vertical along its entire length. The funnel sides had no curves and the changes in profile were abrupt breaks such as at the 950-foot level and just above the tip. The tip had lifted from 160 feet in sketch 17 to 440 feet above the ground and was 40 feet across where it joined the main trunk. The funnel was 320 feet across at the 950-foot level, and widened to 1,150 feet where it faired into the cloud base. The more dense dust cloud (identified by the letter "H") was 190 feet high and was 240 feet across at the top. It resembled a distorted spinning top and

¹ Funnel length taken from tip along centerline of the funnel to the cloud base.

o. 11 because
 direction away

in sketch 17
 3 csr). The
 ne last sketch
 eased length
 tip had low-
 50 feet above
 feet high, ac-
 appeared to
 ed the kinked
 ches (see 18
 ank was much
 pointed with
 st at the time
 20 feet from
 portion of the
 de at the 770-
 vation where
 d base, being
 e same level.
 prominent to
 to the north-
 ud may have
 s from which
 re the funnel
 elephant-trunk

h sketch 18
 ken only 0.9
 e funnel had
 derably. The
 and assumed
 ng its entire
 rves and the
 ks such as at
 tip. The tip
 7 to 440 feet
 cross where it
 was 320 feet
 ened to 1,150
 e. The more
 letter "H")
 across at the
 hing top and

line of the funnel

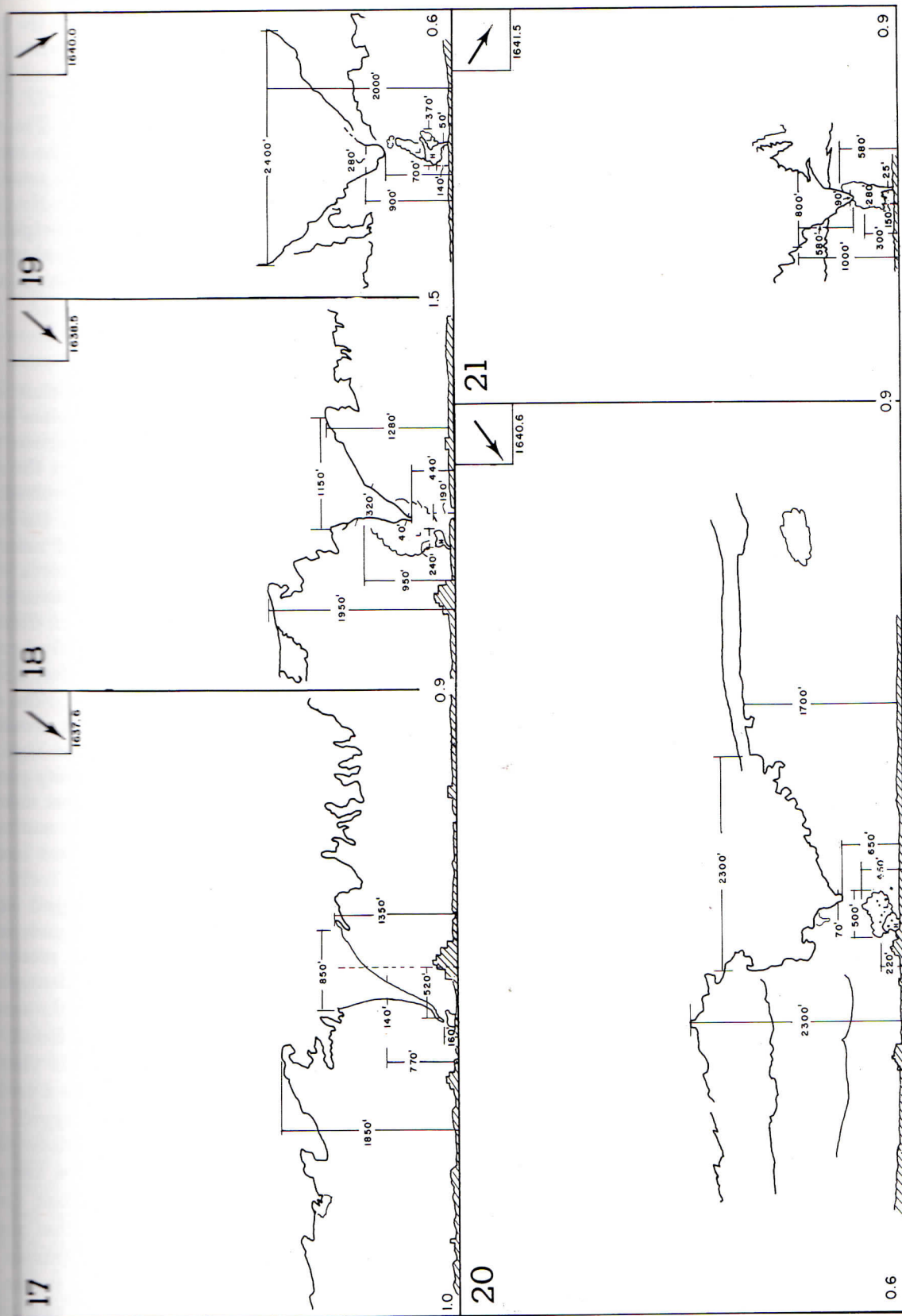

FIGURE 2.—Sketches 17-21.—Rapid changes in the shape and size of the tornado were evident in this period.

its tilted centerline almost coincided with the funnel centerline. A dust cloud of low optical density is outlined by the scalloped lines and indicated by the letter "L".

Just what was the level of the cloud base at this stage is not easily determined. To the right of the funnel the base appeared to be near 1,300 feet in elevation; to the left of the funnel (the southeast) the base appeared to be at 1,950 feet, a difference of nearly 700 feet over the one to the right. If the cloud base level represents the expansion condensation pressure, then there exists the possibility that pressure was lower to the right of the funnel than to the left, at a given level. If that was true, then the vertical pressure gradient to the right of the funnel would have been greater than the static gradient and so vertical motion of the air in that region might be expected. The ragged cloud tags which were to the right of the funnel may be indicative of this upward motion. This characteristic of differential ceiling height prevailed in sketch 17 also. The more favorable viewpoint of the last two photographs revealed this difference. The cloud base to the far left of the funnel sloped downward in a direction away from the funnel and that to the far right sloped upward away from the funnel. Where the funnel was vertical at the location of its entry into the parent cloud this distorted effect was not present and the cloud base sloped upward away from the funnel equally in both directions (see sketches 23-25). The total slope of this funnel was as shown in this sketch since another photo, simultaneous with this but taken at right angles to it, showed no slope.

Photo No. 12 in the section by Beebe locates the tornado between sketches 17 and 18 and there it was in transition between the shape of sketch 17 and that of sketch 18. Photo No. 13 places the tornado about 0.1 mile north of its location in sketch 18; observe the considerable shape change over such a short distance.

Sketch 19

The direction of view for sketch 19 (at 1640.0 CST) was toward the southeast. By this time the tip had lifted to 700 feet from 440 feet above the ground, and the funnel had become stubby. At the 900-foot level the funnel was 280 feet wide; in sketch 18 it had been 320 feet wide near that level. The dust cloud had a 50-foot-wide shaft extending upward from the ground and above the

140-foot level it widened to 370 feet; in the upper portion it appeared to be somewhat twisted. As before, the more dense portion is indicated by the "H" and the less dense portion by the "L". This stage was 1.5 minutes after sketch 18. The viewpoint was almost three times closer to the tornado than for the last sketch so that much associated cloud detail is off the picture. Photo No. 14 in the section by Beebe, located about five-eighths of the way between sketches 18 and 19, shows the funnel withdrawn from the ground much as in sketch 19.

Sketch 20

At the stage of sketch 20, 0.6 minute after sketch 19, several changes had taken place which are shown particularly well by comparison with sketch 18 whose photo was taken from the same location. The cone-shaped trunk had evolved into a wide pre-tornado-type cloud bulge, the cloud ceiling to the left of the tornado had risen 350 feet, and the ragged cloud tags to the north of the tornado had nearly disappeared. Beneath the cloud bulge was a tornado tip 70 feet in diameter and 650 feet off the ground. The vertical extent of the bulge and tip was about 1,600 feet and its width of 2,300 feet was over 0.4 mile. The dust cloud containing chunks of shattered dwellings had a lower level dense portion 220 feet high and 140 feet wide at the base and a low density portion above extending up to 450 feet (200 feet short of the tip) and 500 feet across in a southeast-northwest direction. The dust cloud was leaning toward the tip of the cloud bulge.

Although the cloud bulge had ragged edges, the tip appeared smooth. This smoothness seems to indicate the location of high speed rotary air motion; in a region where several pendant clouds of similar profile exist simultaneously the smooth one probably contains the vortex. Recall the pendant cloud in sketches 9 through 12 that accompanied the tornado; it never became a tornado and its tip particularly remained ragged. As will be seen in the discussion of the tornadic cloud bulge that existed to the east of this tornado, over Dallas, only one of several pendant clouds became smooth and that was the one that picked up light debris over north Dallas (shown by movie camera). Photo No. 15, in the section by Beebe, located the tornado less than 0.1 mile north of the location for sketch 20. The views are

nearly 90
bulge and

Sketch 2

The vi
ward th
so close th
feet of th
appeared
ground w
widening
level. An
mentioned
that exte
280 feet w
that of th
vapor con
wide and
the groun
cylindrica
since it w
minute lat
not showi
last sketch

Sketch 22

In sket
shifted to
the last s
large amo
sketches a
tance from
parison be
and lifted
duced the
sketch 21.
in sketch
leaving a
the same l
able as hig
ragged clo
of the tip
slope of th
toward the
the right)
movement.
300 feet be
tornado, an
the "H")
density du

* The sketch

feet; in the upper
slightly twisted. As
is indicated by the
by the "L". This
sketch 18. The view
closer to the tornado
at much associated
Photo No. 14 in
about five-eighths of
and 19, shows the
ground much as in

0.6 minute after
taken place which
by comparison with
taken from the same
sketch had evolved into
a bulge, the cloud
tornado had risen 350
to the north of the
ground. Beneath the
70 feet in diameter

The vertical extent
1,600 feet and its
0.4 mile. The dust
scattered dwellings
220 feet high and
low density portion
(200 feet short of
in a southeast-
cloud was leaning

had ragged edges.
smoothness seems
in speed rotary air
pendant clouds
smoothly the smooth
vortex. Recall the
rough 12 that ap-
became a tornado
lined ragged. As
the tornadic cloud
of this tornado,
pendant clouds
one that picked
Dallas (shown by
in the section by
than 0.1 mile north
The views are

nearly 90° apart yet the profiles of the tornado
bulge and tip are similar.

Sketch 21

The view for sketch 21 (1641.5 CST) shifted
toward the east-southeast. The cameraman was
so close that considerable detail of the lower 1,500
feet of the tornado was recorded. The funnel
appeared to have lowered to 450 feet from the
ground with a 90-foot-wide tip with the funnel
widening to 800 feet in diameter at the 1,000-foot
level. An odd-shaped cloud between the afore-
mentioned tip and the ground was photographed
that extended to 580 feet in elevation and was
250 feet wide. Its color² was almost identical to
that of the funnel so it is presumed that it was
water condensation. Observe the narrow 25-foot-
wide and 150-foot-long shaft that extended from
the ground to the wide cloud. This off-center
cylindrically shaped cloud was not transitory
since it was shown in a photograph about 0.4
minute later but with the narrow, low-level tube
not showing. This stage was 0.9 minute after the
last sketch.

Sketch 22

In sketch 22, the direction to the tornado
shifted to the west-southwest, and the time since
the last sketch was 0.9 minute. The relatively
large amount of time between these last few
sketches and the changing angle of view and dis-
tance from the tornado allow little direct com-
parison between them. Briefly, the tip lowered
and lifted between sketches 20 and 22, and pro-
duced the odd-shaped cloud below the tip in
sketch 21. Compared with sketch 20, the bulge
in sketch 22 had pulled upward from the tip
leaving a 180-foot-long, 70-foot-wide tip at about
the same level. Tornado cloud detail was detect-
able as high as 2,300 feet above the surface. Many
ragged cloud appendages appeared to the right
of the tip and a few were to the left. Again the
slope of the associated cloud bulge was less steep
toward the direction of movement (which was to
the right) than in the direction away from the
movement. The base of the dust cloud was nearly
300 feet behind (to the south of) the tip of the
tornado, and the high-density portion (located by
the "H") was vertical. The intervening low-
density dust cloud leaned over toward the tor-

²The sketch was extracted from a color slide.

nado tip. The dust cloud was complex as shown
by the high and low density components. The
dense portion was 250 feet high and was 80 feet
wide at the ground, or just a little over the width
of an average residential dwelling lot.

Photos Nos. 16 and 17 are located by Beebe as
being halfway between sketches 21 and 22 of this
section. The detached cloud to the right of the
tornado tip in photo No. 16 resembles that in
sketch 21, while photo No. 17 appears generally
more like sketch 22.

To the far right of sketch 22, northwest of the
tornado and 0.8 mile west of its path are shown
a tall and a short smokestack. Smoke (marked
"P") was flowing from the short stack during
the passage of the tornado, and this smoke was
used as a tracer of air flowing in the vicinity of
the tornado. Prior to the time of this sketch it
appeared that the smoke had been flowing with a
component to the left (that is, the south) but at
a shorter time before the photograph was taken
a shift toward the right (the north) had taken
place. The tornado was 1.1 miles southeast of the
stack at this time.

Sketch 23

In sketch 23, looking to the west, the funnel tip
had lowered to 530 feet above the ground, the tip
had two sections, one 70 feet wide, and a larger
section 200 feet wide at a higher elevation. (This
was 0.9 minute after the last sketch.) Higher
still the funnel had a section 750 feet in diameter.
Large vertical appendages developed and hung
from the periphery of the funnel. The one on
the right was 480 feet in vertical extent and the
one on the left (the south side) was over 700 feet
long. Whether or not these were incipient fun-
nels is not known, but in some movies taken at
about this time they appeared to be no more than
peripheral cloud appendages rotating around the
funnel, and in the movie they did not appear to
change very rapidly in shape or dimension, which
indicated nonturbulent airflow in that region. In
a later sketch one of these appendages reached
nearly to the ground, and at that stage indeed had
the appearance of a narrow vortex. Evidence of
rotational flow, described in a later section, close
to the tornado indicates that these appendages
may actually have been incipient vortices. The
dense dust cloud tapered outward from 100 feet
in width at the surface to 300 feet in diameter at
its widest, and was 330 feet high. The overhang

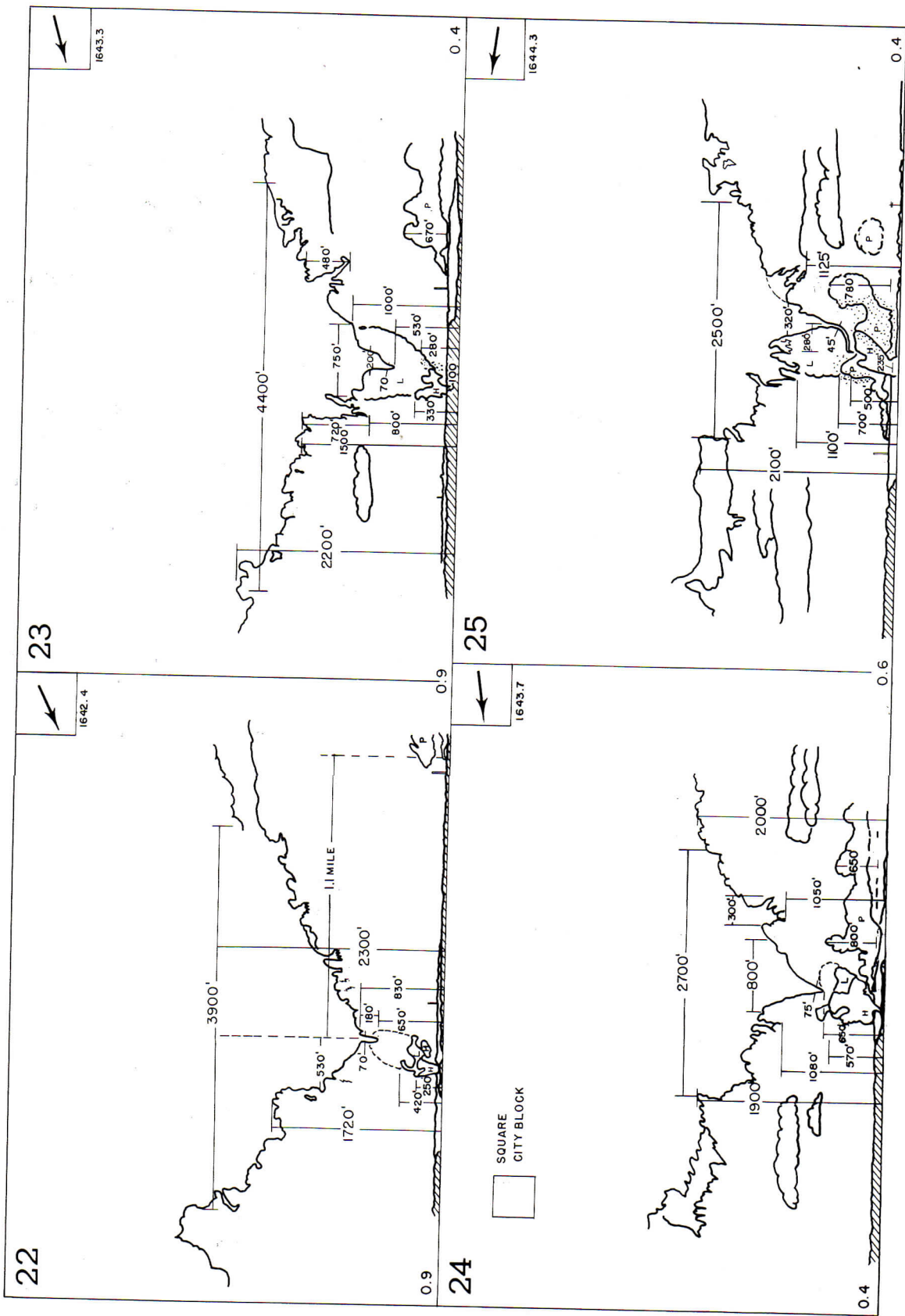

FIGURE 2.—Sketches 22-25.—The tornado had enlarged in this series. Observe the smokestack effluent moving to the right (northerly) with the tornado. A square city block, drawn to scale, has been inserted in sketch 24 for comparison with the size of the tornado.

to the
semb
graph
such
vertic
densit
tion i
to at
as w
at the
presu
photo
in an
The
of clo
earlie
east o
letter
term
indica
wind
eddies
cause
photog
not ex
wind a
sketch
stead,
weak
ever, th
the sta
plume
nado th
than at
was ma
the plu
appear
since th
the rig
rection
southea
tornado
Sketch
Four-
showed
650 feet
than in
tion in w
tip of th
to 800 f
vertical

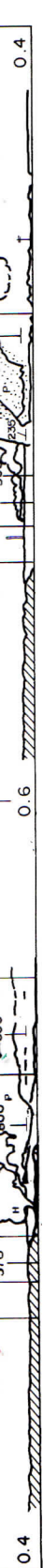

FIGURE 2.—Sketches 22-25.—The tornado had enlarged in this series. Observe the smokestack effluent moving to the right (northerly) with the tornado. A square city block, drawn to scale, has been inserted in sketch 24 for comparison with the size of the tornado.

to the right of the high density dust cloud resembled the overhang of dust clouds photographed with the Scottsbluff tornadoes [5] where such formations were taken to be evidence of vertical shear in the ascending air. The low density dust cloud extended from the dense portion in the manner shown by the scalloped lines to at least an elevation of 1,000 feet, and it was as wide at the top as the 750 feet of funnel width at that elevation. Many chunks of what were presumably shattered dwellings were seen in the photograph and are represented by the large dots in and around the dust cloud.

The tornado had continued toward its position of closest approach to the smokestacks mentioned earlier, and at this stage was 0.9 mile east-southeast of them. The smoke plume, indicated by the letter "P", appeared to indicate a condition termed "looping" in micrometeorology, which is indicative of strong lapse conditions and low wind speed [6]. Under this condition, thermal eddies cause the smoke to rise rapidly and then cause it to be carried downward again. Later photographs indicate that a strong lapse rate did not exist. Most likely, low-speed intermittent wind allowed the smoke to rise in puffs. After sketch 23, no more tall puffs were created, instead, a "coning" [6] of the effluent indicated a weak vertical temperature lapse condition. However, the stack effluent had risen to 670 feet above the stack top at this stage. Since the smoke plume was farther from the camera than the tornado the scale at the plume location was different than at the tornado. Accordingly, an allowance was made in computing the height and length of the plume. At this time the smoke plume did not appear to be affected by the tornado circulation since the puffs also moved with a component to the right, but if the plume had followed the direction of the ambient wind, which was from the southeast, the intersection of the plume by the tornado would never have taken place.

Sketch 24

Four-tenths minute later sketch 24 (1643.7 CST) showed the tornado with its tip raised a little to 650 feet; its general shape was more symmetrical than in the previous sketch, especially in the portion inward from the peripheral cloud tags. The tip of the funnel was 75 feet wide and widened to 800 feet in diameter at the level where the vertical cloud tags were attached. The width of

the cloud bulge at 1,900 feet above the ground was about 2,700 feet. The large dust cloud extended upward from a very narrow shaft of dust near the ground to the extent that it was 550 feet wide and over 650 feet high. The portions labeled "H" had high optical density, those portions labeled "L" were lighter in density; the portion at the upper right outlined with scalloped lines was very light. The high degree of overhang suggests eddies with horizontal axes generated by high velocity upward airflow near the center of the tornado and lower speed upward-moving air in the outer portions as mentioned earlier. The dust cloud still lagged to the south of the funnel. The view was to the west at this stage.

The funnel was at the position of closest approach to the smokestack and the plume had the same general appearance as in the last sketch; however, no more tall puffs had developed. Again the vertical portions extended from 650 to 800 feet above the stack. Evidence that the plume was being drawn toward the tornado was shown by the fact that smoke appeared to be flowing between the crest of the hill and the camera location, a condition that did not exist in the last sketch. Such a component of flow, against the ambient wind and toward the tornado, would indicate some mechanism that was disturbing the ambient flow such as lower pressure in the direction of the tornado or its thunderstorm system.

Sketch 25

By the time of sketch 25 (1644.3 CST), 0.6 minute after the last sketch, considerable size and shape change occurred in the region below 2,100 feet in elevation. The funnel cloud was only 320 feet wide at the 1,200-foot level, whereas in the last sketch it was about 800 feet across at the same elevation. Note how the tip had narrowed to a ropelike tube 45 feet or less in diameter, and had taken on a sharp "S" curve; this was a large change from the earlier sketch. The peripheral cloud pendants continued to be prominent and as mentioned earlier, were rotating around the funnel, as shown by some of the movies. The entire dust or debris cloud was dense and was 235 feet wide at the ground, and extended to the tornado tip at 500 feet elevation. The dots scattered beneath the funnel represent chunks of debris that were seen in the photograph. Their path of arrival at the position shown is not determinable.

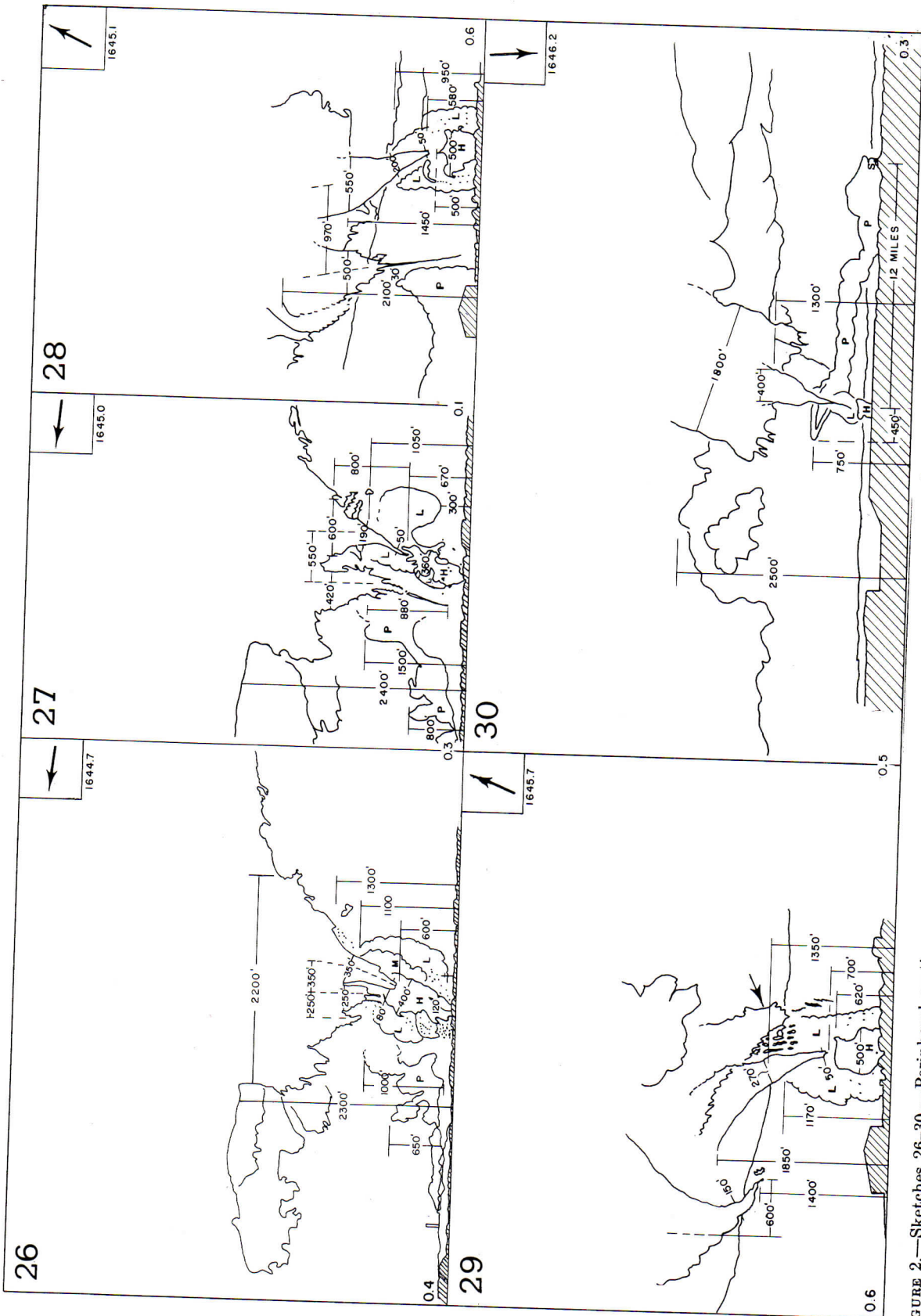

FIGURE 2.—Sketches 26-30.—Peripheral vortices appeared in sketches 27 to 29, and the smoke plume, shown extending from its stack at 'S' to the tornado, started to move around the tornado in sketch 30.

The cloud
 from the
 The to
 the smo
 east-nor
 plume co

Sketch 2

In jus
 straighte
 like tube
 whose tip
 was 80 f
 the cloud
 feet in di
 width wa
 remained
 1,700 feet
 had risen
 cloud wa
 widened t
 was over t
 "H" letter
 low, medi
 dreds of s
 debris cou
 cloud. De
 1,300 feet
 cloud, look
 mediatly t
 fourths as
 sharp poin
 This rotate
 the next sk
 above 1,300

The smol
 the vicinity
 tered in de
 were low-de
 which were
 no more put
 This means
 creased in s
 come steady
 stack had be
 the stack lev
 tional distur
 outer circula
 north of wes



Figure 2.—Sketches 26-30.—Peripheral vortices appeared in sketches 27 to 29, and the smoke plume, shown extending from its stack at "S" to the tornado, started to move around the tornado in sketch 30.

The cloud ceiling of 2,100 feet showed little change from the last few sketches.

The tornado had passed the closest approach to the smokestack and at this stage was 0.9 mile east-northeast of it. The elements of the smoke plume continued to move to the right.

Sketch 26

In just 0.4 minute (sketch 26) the funnel straightened out of the sharp "S"-shape and ropelike tube to a gently leaning, chopped-off cone, whose tip was now 600 feet above the surface and was 80 feet wide. The width of the funnel at the cloud base was a little smaller being now 2,200 feet in diameter; at an elevation of 1,200 feet its width was 350 feet. The peripheral cloud tags remained with the tornado. The funnel hung 1,700 feet below the 2,300-foot cloud base, which had risen 200 feet since the last sketch. The dust cloud was 120 feet wide at the ground and widened to 400 feet at the greatest width, and was over 600 feet in height. The "L", "M", and "H" letters indicate regions of debris offering low, medium, and high optical density. Hundreds of small pieces and a few large chunks of debris could be seen floating around the dust cloud. Debris particles were carried as high as 1,300 feet to the right of the funnel. A pendant cloud, looking much like another funnel, was immediately to the left of the tornado; it was three-fourths as wide as the funnel itself, and had sharp pointed streamers extending downward. This rotated around the funnel as will be seen in the next sketch. High up along the cloud bulge above 1,300 feet, ragged cloud tags persisted.

The smoke plume was again outlined, but in the vicinity of the tornado difficulty was encountered in determining which of the clouds seen were low-density debris from the tornado, and which were effluent from the stack. Observe that no more puffs had developed in the stack effluent. This means that the wind in that area had increased in speed after the last puff and had become steady. The puff most distant from the stack had been lifted to nearly 1,000 feet above the stack level, and this may indicate some additional disturbance of the plume by the tornado outer circulation. The view was still just a little north of west.

Sketch 27

Sketch 27, 0.3 minute later (at 1645.0 CST), showed that the funnel had narrowed again somewhat as it had in sketch 25. Size and shape change occurred very rapidly in this tornado. The lower portion and tip were ropelike. The funnel near the tip was 50 feet wide, then expanded to 190 feet at the 1,050-foot level, and was 600 feet in diameter at the 1,470-foot level. The tilt to the right (25°) remained, as was characteristic of many of the sketches. The large cloud pendant mentioned in the last sketch was more prominent here and it had extended nearly to the ground. It was 420 feet wide at its top and was 1,400 feet in length; however, the lower, narrow portion was rather hazy and the solid upper part still had ragged edges. This feature was photographed by other cameramen. Observe that the other cloud tags were suppressed at this time. The dust cloud was only 50 feet wide at the ground, but widened rapidly with elevation to 360 feet in diameter. Its upper two-thirds was quite nonhomogeneous, and the distribution of light and dark portions suggests differential air velocities in the dust cloud region. Large chunks of shattered dwelling, some about 30 feet across, were visible close to the lower half of the dust cloud, and small pieces could be seen as high as 1,000 feet above the ground.

The tornado had continued to move toward the intersection point of its path and the smoke plume. There was definite indication from the photograph that the plume was being influenced by the tornado circulation in that the right-hand portion of the plume, that is, the part nearest to the tornado, was being raised considerably higher than the remainder of the plume. At this instance the tornado was 0.95 mile east-northeast of the smokestack. The direction from the camera to the tornado was toward 278° , or a little north of west.

Sketch 28

The view for sketch 28 shifted toward the north-northeast, which reversed the sense of slant of the funnel. The time interval was 0.1 minute so details are seen nearly as in sketch 27, but from a different viewpoint. The cameraman was somewhat closer than for sketch 27, and this narrowed the field of view, obscuring upper-level details of the funnel. The funnel was smooth, was 50 feet

wide at the stubby tip, and widened to 550 feet across at the 1,450-foot elevation. The "dust cloud" did not appear to be dust, but was rather light brown,³ which suggested that it was composed of mud spray. The dense part was 500 feet high and 500 feet wide at the widest and had a small pointed top that pointed toward the tip of the funnel. It also had overhang on the edges, suggesting shear eddies there. Many small chunks of debris were flying all around the debris cloud and the tip of the funnel. The low density portion of the debris cloud extended half way up along the length of the funnel. The large pendant cloud with the long hazy lower portion appeared to be more organized into a funnel-like shape than in the last sketch. This point of view showed it to be almost 1,000 feet from the tornado, center to center, as shown in the sketch. Oddly enough it was tilted in the same sense as the tornado; that is, to the left. The hazy elongated tip reached almost to the ground at this stage.

The smokestack plume was seen entering the picture from the left but it became too light to be followed farther to the right.

Sketch 29

Sketch 29, 0.6 minute after sketch 28, shows the tornado again viewed toward the north-northeast. The tip had risen a little to 700 feet above the surface and the funnel had narrowed generally but was still about 50 feet across at the tip. The dust cloud (or mud-spray cloud) lifted to 620 feet in height (lighter portion outlined in scalloped lines) but there was little change in width. The funnel was 270 feet wide at the 1,350-foot level. The large pendant cloud at the arrow to the right of the tornado was undoubtedly the same one shown to the left of the funnel in the previous sketch. Another ragged pendant cloud developed to the left (to the west) of the tornado and had moved into the view of the camera. Its tip was turned under the funnel as if there had been a component of air movement toward the tornado in the region of its tip.

The smoke plume was about to be intersected at this time by the tornado, but the plume was not very clear in the photograph so its location relative to the tornado was indeterminate. Shortly

³ Sketch 28 was extracted from a color slide.

after this time the plume was carried around the funnel.

Photo No. 18 in the section by Beebe located the tornado about halfway between sketches 28 and 29. The photo was a much closer view (and a different direction) so larger details are lost. However, just to the left of the funnel tip can be seen a part of the incipient funnel shown in sketch 28.

Sketch 30

In sketch 30, the view shifted toward the south. The funnel showed a slant to the right (to the west) and was sharply pointed and narrowly tapered somewhat in contrast to the last two sketches. At the 1,300-foot level it was 400 feet across. Above this level what appeared to be a ring of ragged vertically aligned pendant cloud tags made the tornado suddenly 1,800 feet in diameter there. This shape was maintained for only a short period since only one other photographer (not in this series of sketches) recorded it. The low-level dust cloud was quite opaque, and the base of it was hidden by the nearby buildings.

The photograph for this sketch was taken just after the tornado intercepted the smokestack plume and a ring had started to form around the tornado at a height of 750 feet and had an apparent radius of about 450 feet. It also shows the plume extending all the way from its source to the tornado, a distance of 1.2 miles. The large vertical puffs of the smoke plume shown in the earlier sketches had disappeared by this time and the plume led into the vortex in more of a thin stream. In fact, a movie taken of the tornado from southeast of it a few seconds before the smoke moved around it, showed the smoke plume as a narrow (in vertical extent) streamer moving upward and northeastward, toward the funnel. This streaming upward toward the tornado indicated an upward component of air in the vicinity of the funnel and also explains the relatively high level at which the ring first formed.

A check on the autographic wind record at the Dallas Weather Bureau Office (which was 5.5 miles north-northeast of the smokestack) revealed that the surface wind had been from the southeast, with little variation from midnight to the time of the tornado. This wind direction should

have tak
instead t
Sketch 30
Sketch
the last
was cha
funnel co
was now
in the p
camera.
level. T
which an
last few
dust clou
placed fr
dently th
600-foot
wide but
feet in wi
dust clou
less dense
extended
large edd
proximate
appreciab
near the
complete
tornado a
be determ
one penda
that was
portion o
29. The
feet dista
tion from
The sm
ent radius
other pho
at this sta
Actually,
completely
That part
sketch by
to the plu
sketch 30.
northeast

⁴ Some of t
in the drawing

have taken the smoke away from the tornado but instead the smoke was drawn into the vortex.

Sketch 31

Sketch 31 (at 1646.5 cstr) was 0.3 minute after the last sketch and the direction to the tornado was changed toward the west-northwest. The funnel continued with its very pointed tip which was now 600 feet off the ground and was vertical in the plane parallel to that of the film in the camera. It widened to 800 feet at the 1,600-foot level. The cloud ceiling was around 2,400 feet which amounted to little or no change since the last few sketches. Although both the funnel and dust cloud were vertical, the dust cloud was displaced from beneath the tip of the funnel; evidently the vortex was bent between the 450- and 600-foot levels. The dust cloud base was 90 feet wide but the overhang effect enlarged it to 300 feet in width a short distance higher. The dense dust cloud was 450 feet high at this stage. The less dense dust cloud, marked by the letter "L" extended to 1,100 feet in elevation and had a large eddy at 750 feet⁴ elevation on its left (approximately south) side. Chunks of debris of appreciable size could be seen in the photograph near the low-level dust cloud. Whether or not a complete ring of pendant clouds surrounded the tornado at the time of the last sketch could not be determined, but at this stage (sketch 31) only one pendant was recorded in the photograph, and that was turned inward under the wider upper portion of the tornado cloud, much as in sketch 29. The center of this pendant cloud was 1,200 feet distant in the south (left) component direction from the center of the funnel.

The smoke ring eventually attained an apparent radius of 950 feet but from indications of other photographs the ring around the funnel at this stage was in the process of breaking up. Actually, no photograph showed it extending completely around the tornado at any one time. That part of the smoke plume, located in the sketch by the letter "P", was no longer attached to the plume flowing from the stack as it was in sketch 30. The tornado was 1.4 miles north-northeast of the smokestack at this time.

Sketch 32

In sketch 32, the direction to the tornado was

⁴ Some of the measurements quoted in the text do not appear in the drawings because of lack of space.

again nearly south (just a little west of south) and the time was 0.7 minute later than sketch 31. The funnel had increased its slant to the west to 25° from the vertical. Nineteen hundred feet of the funnel were visible vertically and at the 1,300-foot level it was 400 feet across, just about the same as in the last sketch. The very thin tip was 170 feet off the ground. Note the abrupt widening of the funnel at the 620-foot level to 150 feet in diameter from a twisted, thin, ropelike shape. This resembled the double-walled funnel construction observed by Kangieser [7] and also observed in the Scottsbluff tornadoes [5] of 1955. The dust cloud widened upward from the ground and had less optical density in the core near the ropelike center. It was nonhomogeneous and had isolated dust parcels up along the funnel. The darkest portion of the dust cloud at the instant of the photograph (movies show these dust clouds changing very rapidly with time) was at the ground and extended to the east of the tip; this eastward projection was 470 feet high. At any one time that portion of a dust cloud that is higher than another portion is older in point of time since the movies show the dust cloud parcels moving upward along the trunk. Many large peripheral cloud tags were seen around the upper part of the funnel some of which appeared to be bent inward toward the center of the tornado as shown in sketches 29 and 31, for example.

The plume of smoke that was shown flowing into the tornado in sketch 30, no longer did so in sketch 32, although only 1 minute elapsed since sketch 30. The plume at this stage lay a few degrees to the right (looking south) of a direct line from the stack (at the arrow labeled "S") to the cameraman and was flowing almost toward him. The plume was swinging around more nearly in line with the ambient wind which was from the southeast. The effect of the local tornado circulation was ending at the location of the stack. It is estimated that the direction of the plume was from 210° at the time of sketch 30, and shifted to a direction from 185° following the interception, which amounts to a difference of 25° in a counterclockwise sense. The plume of smoke by this time had been dispersed in the vicinity of the funnel.

The detailed descriptions in the above paragraphs of the interaction of the tornado and the smoke plume may give an indication of the size of the gross tornado circulation. For the Dallas

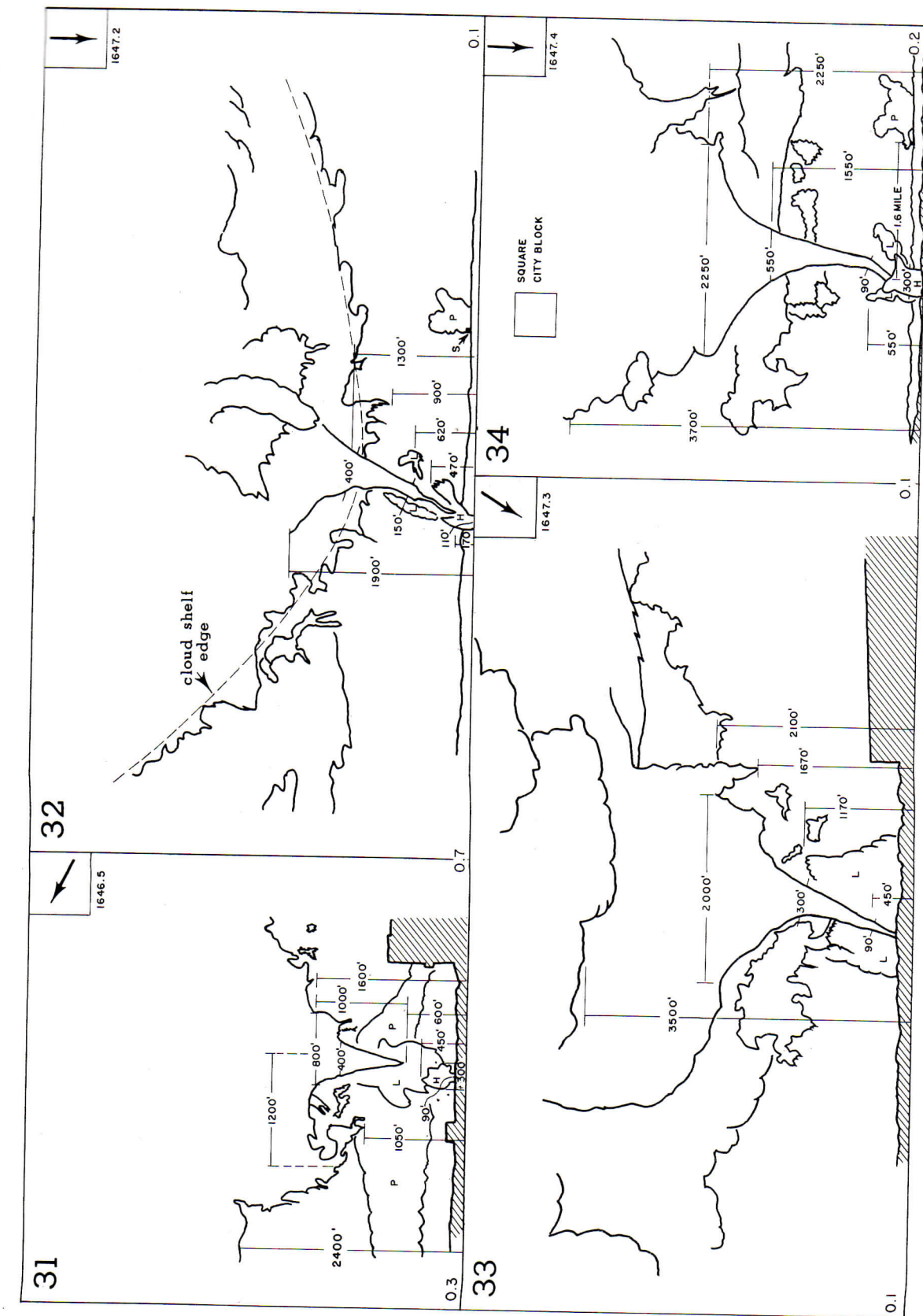

FIGURE 2.—Sketches 31–34.—The tornado became larger and entered the elephant-trunk stage. The dashed curve in sketch 32 points out the edge of the cloud shelf from which the tornado extended downward; see section on Tornado Cloud Structure. A square city block, drawn to scale, is inserted in sketch 34 for comparison with the size of the tornado.

tornado
tend as
about 1,
Photo
the torn
sketches
retracted

Sketch
The d
about so
sketch w
the start
attached
only bel
the west
tilt thro
trunk wa
This sm
tinued th
450 feet
1,170 feet
feet the
may hav
funnel d
At this s
system co
feet in el
hidden by
due to th
dust coul
1,170 feet
Periphera
the funne

Sketch 34
In sket
changed
had passe
narrowed
above abo
cal (reca
below 1,20
tical); no
tilted and
was also v
making th
ward. Th
foot level,
level, and
feet (over



FIGURE 2.—Sketches 31-34.—The tornado became larger and entered the elephant-trunk stage. The dashed curve in sketch 32 points out the edge of the cloud shelf from which the tornado extended downward; see section on Tornado Cloud Structure. A square city block, drawn to scale, is inserted in sketch 34 for comparison with the size of the tornado.

tornado, the radius of influence appeared to extend as far as 1.6 miles for the air layer below about 1,000 feet.

Photo No. 19 in the section by Beebe located the tornado about one-third of the way between sketches 31 and 32. It would seem that the trunk rotated a little between the photo and sketch 32.

Sketch 33

The direction to the tornado in sketch 33 was about south-southwest and the time since the last sketch was 0.1 minute. For the first time since the start of the tornado the funnel became firmly attached to the ground. The funnel was tilted only below 1,300 feet at an angle of 20° toward the west-northwest; the earlier sketch showed it throughout the entire visible funnel. The trunk was becoming smooth and evenly tapered. This smoothing and straightening trend continued through several following sketches. At 1,100 feet in height the trunk was 90 feet across, at 1,300 feet it was 300 feet in diameter, and at 2,100 feet the tornado cloud was 2,000 feet across; it may have been wider at higher levels, but the trunk disappeared into the peripheral clouds. At this stage some details of the tornado cloud system could be seen in the photograph to 3,500 feet in elevation. The low-level dust cloud was hidden by the low ridge in the foreground, but due to the overexposure of the photograph, light dust could be seen over a wide area and up to 1,100 feet as indicated by the scalloped outline. Peripheral clouds, both detached and attached to the funnel, still were rotating around it.

Sketch 34

In sketch 34 (at 1647.4 cst), the tornado had changed considerably although only 0.1 minute had passed since the last sketch. The funnel had narrowed along most of the visible portion and above about 550 feet the trunk had become vertical (recall in the last sketch all of the tornado below 1,200 feet had a slant of 20° from the vertical); now only the part below 550 feet was tilted and possibly the portion nearest the ground was also vertical. In other words, the process of making the funnel vertical had progressed downward. The trunk was 90 feet wide at the 550-foot level, became 550 feet wide at the 1,550-foot level, and at the 2,250-foot level widened to 2,250 feet (over two-fifths of a mile in diameter).

Nearly 3,700 feet of the vertical extent of the tornado cloud system could be seen in the picture. This was made possible by the disappearance of some of the peripheral cloud tags on the side nearest the camera. However, many peripheral clouds were visible as shown in the sketch. The heavy dust cloud was 300 feet wide near the ground and along with the light portion extended to at least 550 feet in height. Although it was vertical at the ground, the dust cloud bent to the west with elevation along with the trunk. Note that due to a thinning of the dust in the vicinity of the trunk, the trunk was visible downward into the dust cloud. Those portions of lower optical density are indicated by the letter "L". Compare the size of the heavy dust cloud with the city block scaled in this sketch.

The orientation of the smoke plume from the stack indicated that it had continued to rotate in a counterclockwise direction after sketch 32, bringing it more nearly parallel to the ambient wind.

Sketch 35

Sketch 35 was viewed nearly toward the south-southwest (toward 210°) and was 0.2 minute after sketch 34. It showed an increased bend in the lower portion of the trunk below 1,000 feet apparently due to the change in direction of view. For example, if the tip were lagging toward the south more than to the east, then a shift of view from south to south-southwest would show the north-south component of bend to better advantage. The angle of tilt amounted to 40° from the vertical at the 450-foot level. Little change had occurred near the ground, but at 1,000 feet the width had increased from 180 feet in diameter to 220 feet and the funnel was 1,250 feet wide at the 1,900-foot level. This cameraman was much farther away from the tornado and so took in more of it hence this photograph showed the funnel cloud system reaching upward at least 4,100 feet. At the 2,900-foot level the tornado cloud system was 3,500 feet across in a northwest-southeast direction. Considerable amounts of peripheral cloud continued to rotate around the funnel above 1,000 feet in elevation. The dust cloud was rather dense below 450 feet and the lighter portion extended to 1,000 feet in height, and at the widest was 700 feet across. The non-homogeneous character of the dust cloud indi-

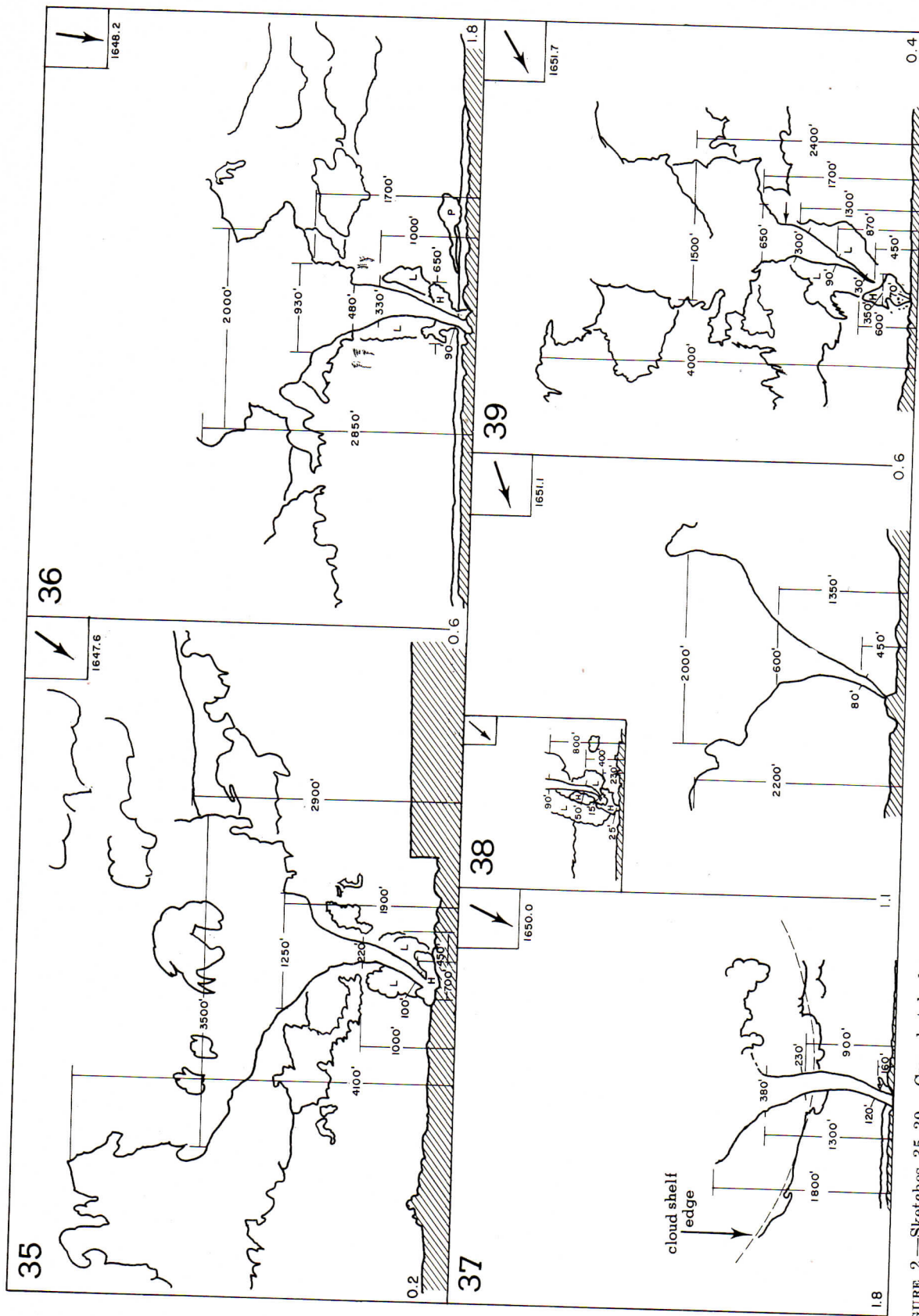

FIGURE 2.—Sketches 35-39.—Cross-hatched area indicates nearer obstructions. Non-cross-hatched areas near the baseline represent more distant ridge. The elephant-trunk stage proceeded to maturity in sketch 37, then the tornado began to retreat. The dashed curve in sketch 37 points out the edge of the cloud shelf from which the tornado extended downward.

ated the is to be mentioned about the periods wh dust (or suddenly s ing consid

Sketch 36

Sketch 3: crease of t more direc time was trunk phas the ground the ground was widen 1,000-foot an increas sketch. T sketch had Above 2,00 in width b ragged. T and the de Its total he the dust w allowed one

The sm changed its clockwise se it streamed divergent f the cameran the tornado (the left) a of this sket one.

Photos N are located map. Howe and photo N

Sketch 37

Although change, ther which dimer rate than us the elephant-second Scott

ated the existence of turbulent eddies there. It is to be remembered that these dust clouds, as mentioned before, are the most changeable thing about the tornado. The movies showed short periods when no dust cloud existed, then suddenly dust (or debris of whatever the composition) suddenly swirled up and around the trunk attaining considerable heights rather quickly.

Sketch 36

Sketch 36 (1648.2 cstr) shows an apparent decrease of tilt most likely due to the shift of view more directly to the south; the amount at this time was 18° from the vertical. The smooth-trunk phase continued and the trunk remained on the ground. The width was a little smaller near the ground, a decrease to 90 feet in diameter, but was widening farther up. For example, at the 1,000-foot level the trunk became 330 feet wide, an increase of 110 feet over that in the last sketch. The smooth-trunk profile of the last sketch had become disrupted above 1,200 feet. Above 2,000 feet the tornado averaged 2,000 feet in width but the sides in that upper region were ragged. The dust cloud was moderately heavy and the dense portion was 650 feet in diameter. Its total height was 1,000 feet. Here, as before, the dust was thinner nearest the trunk, which allowed one to see the trunk almost to the ground.

The smokestack plume appeared to have changed its direction even more in the counterclockwise sense as shown by the manner in which it streamed off to the right; that is, a direction divergent from a line between the tornado and the cameraman. Although not readily apparent, the tornado had developed a tilt toward the east (the left) above the 1,000-foot level. The time of this sketch was 0.6 minute after the preceding one.

Photos Nos. 20 and 21 in the section by Beebe are located between sketches 35 and 36 on the map. However, photo No. 21 resembles sketch 37 and photo No. 20 strongly resembles sketch 34.

Sketch 37

Although a tornado is continually in a state of change, there appear to be configurations during which dimensional changes proceed at a slower rate than usual. One of these configurations is the elephant-trunk stage, and both the Dallas and second Scottsbluff tornadoes [5] changed shape

slowly during this stage. In the Dallas tornado, the smoothly tapered, although curved, trunk was fully developed by sketch 33, and still existed by the time of sketch 37, 2.7 minutes later. The reader will recall some of the large changes that occurred in short time periods between earlier sketches, such as between sketches 12 and 13, or between sketches 5 and 6, when other than the elephant-trunk shape existed.

Between sketches 36 and 37, a matter of 1.8 minutes, the trunk was widening near the ground (diameter increased from 90 to 120 feet), but was narrowing higher up and decreased by 100 feet in diameter both at the 1,000- and 1,300-foot elevations. An increased bend was observed in the trunk. The trunk profile would indicate that the portion near the 700-foot level was farther to the north and west than any part above or below that level. The trunk continued to be generally smooth although close examination of the photograph shows some small irregularities in the surface. One of the surprising things about this stage is that despite the powerful appearance of the funnel, relatively little debris was being stirred up compared to earlier stages when the tip was suspended several hundred feet above the ground and yet much flying dust and debris chunks were seen. This is not to be taken to indicate that less damage was being done. A small eruption of dust on the right-hand side (the west side) 160 feet high was all that was visible. This effect was noticed in some stages of one of the Scottsbluff tornadoes [5] and no logical explanation comes to mind. The degree of exposure of the print was not a factor here in revealing a lack of dust. For this stage the cameraman was so close (0.80 mile) that only 1,800 feet of the funnel were recorded. Sketch 37 represents the maximum development of the elephant-trunk stage.

Sketch 38

By the time of sketch 38, the tornado was beginning to shrink in the lower part and widen above about 900 feet. The trunk diameter was only 80 feet at the 450-foot level, 600 feet at 1,350 feet in height (an increase of over 200 feet), and 2,000 feet at 2,300 feet elevation. The cameraman was so far away (8.5 miles) in this instance that the view of the upper portion of the tornado was hidden by intervening lower-level clouds. This is characteristic of many tornado pictures taken

FIGURE 2.—Sketches 35-39.—Cross-hatched area indicates nearer obstructions. Non-cross-hatched areas near the baseline represent more distant ridge. The elephant-trunk stage proceeded to maturity in sketch 37, then the tornado began to retreat. The dashed curve in sketch 37 points out the edge of the cloud shelf from which the tornado extended downward.

from a distance of more than a few miles. The funnel increased its component of tilt toward the north (this view is to the west-southwest). Due to the distance no dust cloud showed in the photograph. However, in order to show the tip detail at approximately this time, the inset sketch is provided. The photograph from which it was extracted was taken nine times closer than that of the main sketch. This view was toward the southwest so that the funnel tilt shown in the main sketch would have a tendency to disappear. The photographs were not exactly simultaneous so some tilt and width change could easily have taken place. Although the dust cloud contact area was very narrow (25 feet diameter) much debris was being carried up from the ground. The debris cloud below 230 feet was quite dense and was 280 feet wide at its top. Lighter debris was carried up at least to 800 feet. The tornado trunk tip was only 15 feet in diameter, but widened to 90 feet at the 800-foot level and was already lifted from the ground. The dust cloud showed the overhang feature as well as the lack of debris in the center near the core of the trunk. With the tip greatly narrowed and lifting, more debris and dust were being lifted than in the stage of sketch 37.

Sketch 39

By the time (1651.7 CST) of sketch 39, 0.6 minute later, the tornado showed considerable change in shape. The tip was 450 feet off the ground, and the trunk tapered narrowly from there to the 870-foot level where it was only 90 feet across. It widened somewhat stepwise to 300 feet in diameter at the 1,300-foot level; another step-type increase widened it to 650 feet at the 1700-foot elevation. Between 1,800 and 3,200 feet elevation the tornado was 1,500 feet wide. The total height of the tornado cloud revealed in this photograph was 4,000 feet. The tilt angle of the tip was 28° to the north-northwest (the direction of view was nearly toward west-southwest). The height of the tornado cloud complex was virtually the same as that in sketch 35, and the sketches between were made from photographs taken either too close or too far from the tornado to include this height in the view. By this stage of the tornado evolution, it is believed that the cloud base immediately around this tornado was elevated above the general cloud base, which allowed the camera

to include this large vertical extent. Recall that in sketch 38, 0.6 minute earlier, the distant cameraman (8.5 miles away) showed only 2,300 feet of tornado from the ground to the general cloud base; it is believed that the portion above that level in sketch 38, but shown in sketch 39, was hidden by the general cloud base. The photograph for sketch 39 was taken from 1.75 miles. The dense dust cloud was 70 feet wide in surface contact and extended to a height of 600 feet on the left (south) side, and was 350 feet wide. The less dense portion extended upward to a height of 1,300 feet and was 1,000 feet in width at its widest. Large and small chunks of debris were flying in and around the lower, dense dust cloud and some were as large as 20 feet across.

The shape of the tornado at this stage seemed to be an unusual one. The lower 1,700 feet of smooth funnel, resembling a surface of revolution, did not fair smoothly into a general cloud base, but ended abruptly at a portion of the tornado cloud complex which was approximately four times wider than the 400-foot width of the funnel at the elevation of the arrow. This upper 2,300 feet nearly resembled a cylinder with ragged edges. The writer has not seen this feature in any other tornado photographs.

The elevation of the cloud base around the tornado observed in some of the Dallas tornado photographs, and mentioned in the second prior paragraph, may be a feature of tornadoes in general. This has been noticed in several series of tornado pictures, including the Scottsbluff series [5] and was observed to occur in about the mid-third of the tornado life cycle.

Photo No. 23 in the section by Beebe was located almost at the position of sketch 39; the thinly tapered tip in sketch 39 would seem to resemble the closeup shown in photo No. 23.

Sketch 40

The direction of the tornado from the cameraman in sketch 40 was a little northward of west-southwest. The trunk retained the tilt to the north but the angle changed from 28° to 19° from the vertical. The profile of the trunk became smoother and the trunk surface less rough than in the last sketch. The tip had descended to 220 feet from the ground. Observe that the smooth portion of the trunk terminated at 1,700 feet, which was the same level as in sketch 39.

That portion no longer in sketch 39. in the upper side (right) south side tips at the resting the at 2,700 feet compared to 1, was very slender to 110 feet 370 feet at been more photograph was relative face contact of 50 feet of 550 feet across to an elevation hang was seen the south side chunks of debris above the ground

Sketch 41

The narrow been taking of sketch 3 the time of very slender off the ground from the vertical sketch. The height of 9 having decreased 1,550-foot level and at elevation The vertical creased from feet. The mentioned elevation of the tornado The minimum now only 85 minute earlier least 4,250 feet photograph, in the last sketch erably more with 630 feet

Recall that distant camera by 2,300 feet general cloud above that sketch 39, was photograph miles. The surface contact feet on the wide. The to a height width at its debris were dust cloud cross.

stage seemed 700 feet of of revolution general cloud of the tornado approximately width of the This upper under with when this features.

around the tornado photograph prior parameters in general. of tornado series [5] and mid-third of be was located sketch 39; the could seem to No. 23.

the camera toward of west-tilt to the 28° to 19° the trunk became less rough and descended we have that the at 1,700 sketch 39.

That portion of the tornado above 1,700 feet was no longer cylindrical in appearance as it was in sketch 39. Instead, large indentations appeared in the upper portion at 2,700 feet on the north side (right-hand side) and at 3,000 feet on the south side (left hand). The shape of the cloud tips at the edge of this portion was curled, suggesting the presence of shear eddies. The width at 2,700 feet elevation was about 1,350 feet compared to 1,500 feet in the earlier sketch. The tip was very slenderly tapered and the trunk widened to 110 feet at the 950-foot elevation, and then to 370 feet at the 1,700-foot level. There may have been more tornado cloud above 4,200 feet but the photograph ended at that level. The dust cloud was relatively small and of low density. Its surface contact area was 120 feet across (an increase of 50 feet over the last sketch) and it widened to 550 feet across at the widest and could be detected to an elevation of 650 feet. Considerable overhang was shown and a shear eddy appeared on the south side (the left-hand side). Many small chunks of debris were visible up to about 350 feet above the ground.

Sketch 41

The narrowing of the lower portion that had been taking place in this tornado since the time of sketch 37, 2.4 minutes before, had ceased by the time of sketch 41. The tip, which was still very slender and pointed, was only a little higher off the ground than before; its tilt angle was 28° from the vertical, an increase of 9° over the last sketch. The trunk was only half as wide at a height of 950 feet as it was in the last sketch, having decreased from 110 feet to 50 feet. At the 1,550-foot level, it was only 110 feet in diameter and at elevation 2,000 feet it was 530 feet wide. The vertical extent of the smooth trunk had increased from 1,700 feet in the last sketch to 2,000 feet. The indentations into the upper portion, mentioned earlier, continued to invade that part of the tornado and effectively reduce its diameter. The minimum diameter in the upper portion was now only 850 feet, whereas in sketch 39, only 0.7 minute earlier, it had been 1,500 feet wide. At least 4,250 feet of the tornado were visible in this photograph, which was just about the same as in the last sketch. The dust cloud was considerably more dense than in the last drawing, but with 630 feet to its top it had not increased in

height. It had only a 70-foot-wide surface contact area, but widened rapidly to 470 feet. It was nonhomogeneous and showed evidence of turbulent eddies. The portion of the tube below 1,000 feet tilted 28° from the vertical toward the north; from other pictures taken near this time and from another point of view, it was determined that the tornado was also leaning with a component toward the photographer.

Until about this stage the tip of the tornado as well as its ground-based dust cloud lagged to the south of the upper part of the tornado. Now the tip and top began to have an east-west separation as well that continued to increase until the time that the tornado core began to shrink along its length. The effect was to have the tornado moving in a direction at about 45° from its long dimension.

Sketch 42

The tip of the trunk lifted in sketch 42 (at 1652.6 CST) to 700 feet above the ground (from 270 feet) so that only 1,200 feet of smooth trunk existed at this time. Three hundred feet above the tip the trunk width was 50 feet, and at the 1,100-foot level above the ground it had widened to 140 feet. At the top of the smooth portion the diameter had decreased somewhat, the smooth bulge of the prior sketch disappearing. The portion of the tornado above 1,900 feet had suffered further inroads on its diameter. At the 2,900-foot level, there was a diameter of only 680 feet, whereas in the previous sketch the diameter was 850 feet in that region. The total effect was a widening below 1,600 feet and a narrowing above that level. Although the indentations in the upper portion were cutting into the tornado cloud there, what was left at the upper level began to resemble an extrapolation of the lower smooth portion based on a constant increase of width with height. The disk-shaped cloudform between 1,900 and 2,700 feet was 2,100 feet across and in one form or another had existed since sketch 40, a lapse of 0.5 minute. The left and right edges of the disk-shaped cloudform had downward-turning cloud tags which suggested shear in those regions, with relatively stronger upward airflow at smaller radii than the cloud tags. Other curled cloud tags suggested turbulent eddies. The cloud ceiling near the tornado appeared to remain near 4,000 feet. The funnel was considered to have

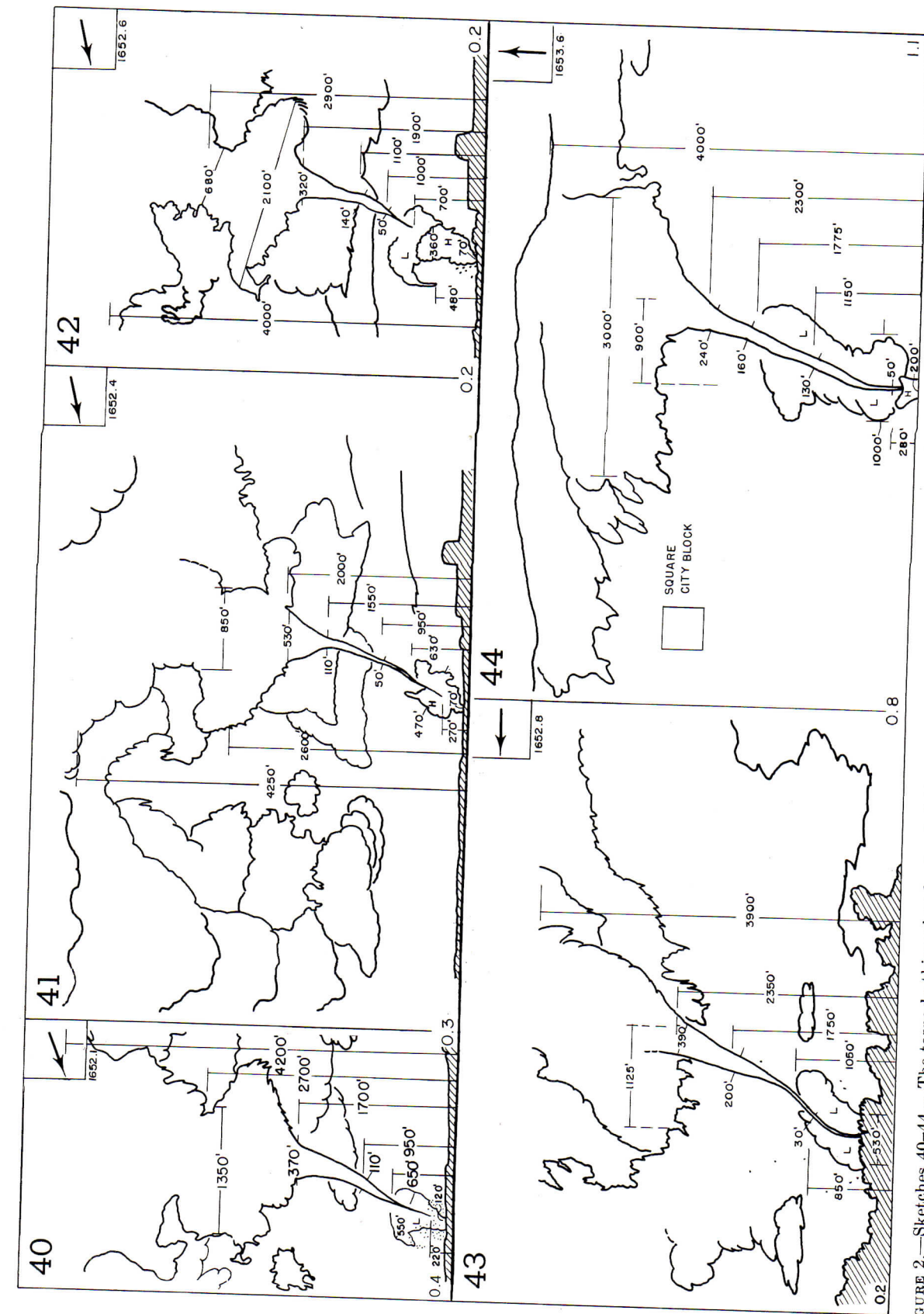

FIGURE 2.—Sketches 40-44.—The tornado thinned and retracted through sketch 42, then revived and returned to the ground between sketches 43 and 44. It had become considerably taller than when it started. Note the cumuliform clouds in the background. A square city block, drawn to scale, has been inserted in sketch 44 for comparison with the tornado.

had a com
at this tim
dense port
dense part
ground. La
part, espec
tip), and c
surface con
eter, and m
to the left o
This stag
shrinkage o
since the mi
of sketch 3

Sketch 43

The dire
sketch 43 w
700 feet ab
had presum
the smooth
least 2,350
indicates the
tornado tha
The trunk a
it had a con
25° from the
assumed a
graph taken
looking tow
that the tul
ponent of til
only 30 feet
smaller than
widened to
and to 390
chunks of de
along the tr
in the print
cloud seen i
point of vie
might have
the 2,350-fo
with the thi
feet in high
treetops. It
indicated she
the case wit
dust cloud w
did not exte
have been a



FIGURE 2.—Sketches 40–44.—The tornado thinned and retracted through sketch 42, then revived and returned to the ground between sketches 43 and 44. It had become considerably taller than when it started. Note the cumuliform clouds in the background. A square city block, drawn to scale, has been inserted in sketch 44 for comparison with the tornado.

had a component of tilt toward the cameraman at this time. The dust cloud was larger, with the dense portion being 700 feet high and the less dense part extending up to 1,000 feet above the ground. Large eddies were indicated in the upper part, especially to the left (to the south of the tip), and overhang was evident as usual. The surface contact area remained at 70 feet in diameter, and many large chunks of debris were seen to the left of the dust cloud up to about 250 feet.

This stage marks the end of the temporary shrinkage of the funnel that had been in progress since the middle of the large elephant-trunk stage of sketch 37.

Sketch 43

The direction to the tip of the tornado in sketch 43 was directly west. Whereas the tip was 700 feet above the ground in the last sketch, it had presumably returned to the ground here and the smooth section of the trunk had risen to at least 2,350 feet above the ground. This sketch indicates the beginning of the enlargement of the tornado that continued for the next few sketches. The trunk above 1,200 feet was straight, although it had a component of slant toward the north of 25° from the vertical. Below that the thin tube assumed a shallow "S"-shape. Another photograph taken at very nearly the same time, but looking toward the north at the funnel, showed that the tube above about 500 feet had a component of tilt toward the east also. The tube was only 30 feet across at the 850-foot level, and was smaller than that at lower levels. Above that it widened to 200 feet at the 1,750-foot elevation, and to 390 feet at the 2,350-foot level. Small chunks of debris were seen nearly 1,500 feet high along the trunk. Not much detail was visible in the print above 2,350 feet, but the disk-shaped cloud seen in sketch 42 was either gone or the point of view made it unidentifiable. Some of it might have been to the left of the trunk above the 2,350-foot level. The dust cloud tilted over with the thin lower tube and extended to 1,050 feet in height; it was 530 feet in diameter at the treetops. It was nonhomogeneous in texture and indicated shear eddies along its edges as had been the case with the other photographs where the dust cloud was shown. Just why the dust cloud did not extend all the way up the funnel might have been a function of the vertical wind veloci-

ties found in that region. The other photograph showing the funnel tip from the south and at nearly the same time revealed large chunks of dwelling up to 200 feet above the ground.

Sketch 44

The time of sketch 44 (1653.6 cst) was 0.8 minute after the last sketch, and the direction of view was shifted to one toward the north. This view indicated how far the top of the funnel extended to the east of the tip, a distance of 900 feet. The tilt toward the east was 25° from the vertical. The trunk rose from a 50-foot-wide vertical tip into a gradually widening and slanting portion that became 240 feet in diameter at an elevation of 2,300 feet. The vertical extent of the tornado cloud complex amounted to 4,000 feet. It widened rapidly above 2,300 feet into the upper associated cloud system which was 3,000 feet across in a west-east direction. The dust cloud was dense to a height of 280 feet and had a surface area 200 feet across. The less dense portion was about 1,000 feet wide and extended upward to the 1,775-foot level. Overhang and evidence of turbulent eddies continued to characterize the dust cloud.

Photo No. 24 in the section by Beebe was located about halfway between sketches 43 and 44, along the tornado path. The portion of the tornado in the photo clearly resembles the lowest part of sketch 44.

Sketch 45

The direction to the tip of the tornado in sketch 45 was nearly northwest. By examining other photographs, it was found that the funnel was tilted in a direction nearly parallel to the plane of the picture, but with the upper part a little closer to the photographer, so that the direction of tilt was actually toward the northeast. Therefore, at this time the tornado was traveling in a direction about 45° to the left of its direction of tilt. The angle of tilt above 600 feet was 35° from the vertical. This allowed the tip to lag 1,800 feet southwest of the position where the tornado trunk joined the associated cloud at about a height of 3,000 feet. The trunk was 40 feet wide at the height of 370 feet, widened to 250 feet at an elevation of 1,400 feet, then to 700 feet in width at the 2,400-foot level, an increase of nearly 450 feet at that level. The trunk had a

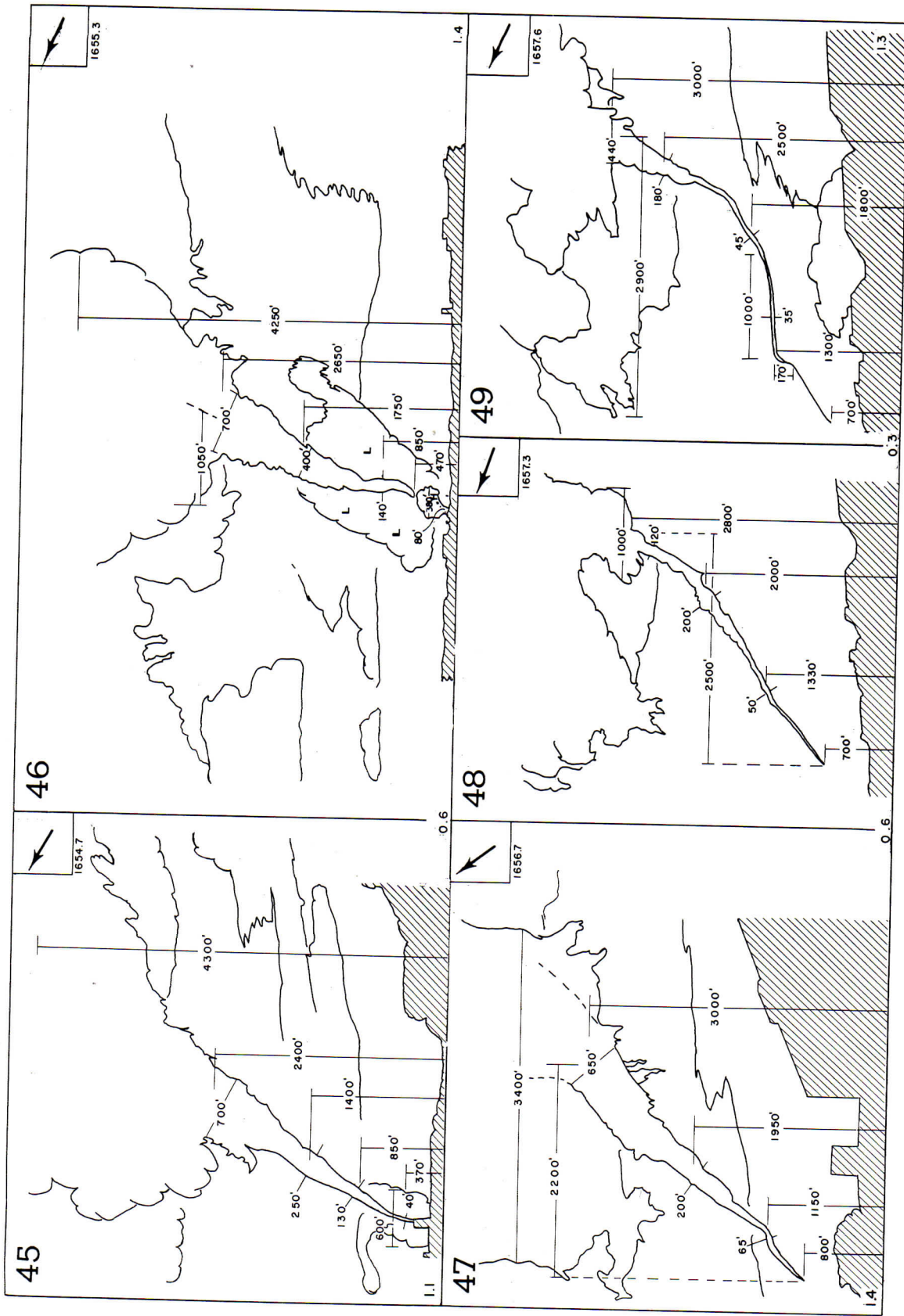

FIGURE 2.—Sketches 45-49.—The tornado ended its temporarily revitalized stage in sketch 45, and began its final retreat into the parent cloud. In this process it became very slender and long. Note the stratus clouds low in the background.

rather even roughness. above the ground below about was 600 feet erately dense the left from one-tenth m

Sketch 46

In sketch the direction northwest, s ing was ap upper part toward the tip had lift The trunk w (little chang in diameter feet at an 1,750-foot le dust cloud trunk was b above 1,000 rotating arc they were r sketch 35. high, had a zon, then w taining a la extended up loped outlin leaned with its upper r cloud indic not just the

Sketch 47

One and showed the of tilt, here The direction about north tornado wa east of nor but shortly



FIGURE 2.—Sketches 45-49.—The tornado ended its temporarily revitalized stage in sketch 45, and began its final retreat into the parent cloud. In this process it became very slender and long. Note the stratus clouds low in the background.

rather even taper but showed some degree of roughness. The cloud ceiling was over 4,300 feet above the ground. Note that the tip was vertical below about 200 feet in elevation. The dust cloud was 600 feet wide and 850 feet high and was moderately dense. Note the odd-shaped extension to the left from the top of the dust cloud. One and one-tenth minutes elapsed since the last sketch.

Of the still pictures collected of this tornado, this one represents the greatest extent of the temporary enlargement of the tornado just before it started its shrinkage to extinction.

Sketch 46

In sketch 46, 0.6 minute later (at 1655.3 cstr), the direction to the tip shifted toward west-northwest, so that the 35° tilt in the prior drawing was apparently decreased to 25° here. The upper part of the trunk was leaning a little more toward the cameraman than in sketch 45. The tip had lifted to 470 feet and was rather stubby. The trunk was 140 feet wide at the 850-foot level (little change from No. 45), widened to 400 feet in diameter at the 1,750-foot level, and on to 700 feet at an elevation of 2,650 feet. Below the 1,750-foot level the trunk and tip along with the dust cloud described a shallow "S"-curve. The trunk was becoming rather rough on its surface above 1,000 feet. Peripheral cloud tags still were rotating around the upper part of the trunk, but they were not as prominent as they were before sketch 35. The low-level dust cloud was 470 feet high, had a width of only 80 feet near the horizon, then widened to 380 feet in diameter, maintaining a large degree of overhang. Light dust extended up to 1,750 feet as shown by the scalloped outline. It was 1,200 feet across and it leaned with the trunk. A large eddy showed on its upper right extremity. The tilt of the dust cloud indicated that the entire vortex tilted and not just the core alone.

Sketch 47

One and four-tenths minutes later, sketch 47 showed the tornado trunk at an increased angle of tilt, here amounting to 45° from the vertical. The direction of view to the tip was 325° or just about northwest. The direction toward which the tornado was leaning was estimated to be a little east of northeast. The tip was off the ground, but shortly before this a color slide showed the

trunk extending below the tops of a row of trees, and most likely touching the ground; however, the color-slide photographer was closer to the tip and the lighting was more favorable at his location. Nevertheless, the photograph for sketch 47 showed the tip as having been nearly 800 feet off the ground. The trunk was 65 feet in diameter at the 1,150-foot level (note the bend there), widened to 200 feet at 1,950 feet elevation, and at 3,000 feet it was 650 feet across. The tip lay 2,200 feet southwest of the center of the funnel at the 3,000-foot level. The funnel by now was shrinking again and its surface was yet rather rough. There was a hint that above the 3,000-foot level the trunk had started to return to the vertical attitude. Some small peripheral cloud tags were seen in the photo around the upper portion of the trunk. The dust cloud, if it did exist, was not visible in this exposure. The tip was over Bachman's Lake at this stage.

Sketch 48

Sketch 48 (at 1657.3 cstr) showed a considerable change in the tornado cloud system since the last sketch. At this stage the straight portion of the trunk lay at an angle of 50° from the vertical and the direction from the tip to the top was toward a bearing of about 25° . The direction of view was toward 280° and the top of the tornado was leaning toward the cameraman as well as to the right in the plane of the picture. The tube was smooth except in the wider portion a little above and below the 2,000-foot level, where the surface was quite ragged. There was some suggestion that this ragged portion had started at a lower level and had traveled upward along the tube. The dark cloud accompanying the top of the tornado which early in the tornado lifetime was rather extensive, had become smaller and appeared less dark in the picture from which this sketch was taken. The tip was 700 feet above the ground at this time. The trunk widened to 50 feet at the 1,330-foot level, was 200 feet in diameter in the rough region at 2,000 feet above the ground, then decreased to 120 feet between there and the collar-shaped cloud. The collar-shaped cloud was 1,000 feet across. The tip lay nearly 2,500 feet horizontally from a point under the top. The trunk had a shallow "S" curve from top to tip. According to computations the tip was just a short distance north of the north shore

of Bachman's Lake. Another photo, taken just as the tip reached the south shore of the lake, showed the tip apparently reaching the ground, and it was nearly vertical in the first few hundred feet above the ground. Six-tenths minute elapsed after the last sketch. If any dust or debris cloud existed it was not visible in the photograph.

As indicated in the discussion of the last sketch the upper portion of the tornado was returning toward a vertical alignment.

Sketch 49

In sketch 49, the trunk thinning process continued and, in addition, the horizontal projection of the trunk on the ground had increased from 2,500 feet to 2,900 feet in length. The tip was still 700 feet from the ground, the nearly horizontal portion was 1,300 to 1,500 feet in elevation, and the top was nearly 3,100 feet high. Only the portion above 2,200 feet exhibited a rough surface. Note that the collar-shaped cloud that was around the top in the last sketch no longer existed. The dark cloud accompanying the top of the tornado had again decreased in size. The tip section lay at an angle of 60° from the vertical and the portion above the 2,000-foot level had an angle of 22° from the vertical. The horizontal part was 1,000 feet long. At this stage a color slide showed that the portion in the vicinity of the 1,900-foot level had the hollow structure often associated with waterspouts [7]. This tornado tip, as mentioned before, had just crossed a small lake a short time before, but it had crossed the short dimension (amounting to 0.3 mile) and so had spent little time over the water. Witnesses claimed that the tip disturbed the water considerably [3], but it is unwise to state that this short time over the lake could have imparted waterspout characteristics to the tornado. The tube was very narrow here, being only 35 feet across in the center of the horizontal portion and increasing to 45 feet farther up the tube near the upper bend. At the 2,500-foot level it was 180 feet wide and at 3,000 feet it had a diameter of 440 feet, just the size of a city block ($\frac{1}{2}$ mile). The stability of this vortex seemed remarkable in that it existed with such a narrow taper with such length, which at this stage amounted to 4,000 feet in the plane of the picture.

Near this same time other photographs taken from south of the tornado (looking north) showed that the bent funnel did not lie in a single

vertical plane. For example, the part of the funnel above about 1,800 feet was leaning toward the cameraman for sketch 49, and the other part below that elevation appeared as a nonsymmetrical corkscrew lying in the plane of the picture for sketch 49. Evidently other tornado pictures showing the kinked or curled-up form are those looking parallel to the nearly horizontal, yet bent tube; a photograph at right angles to that would straighten out many of the kinks (as was the case for the stage of sketch 49).

Another interesting observation concerns the parent cloud from which the tornado depended. As the tornado moved northward through the city the extent and the blackness of the parent cloud decreased. Several photographs having both the main tornado and the funnel cloud to the east of it in view (the one that eventually dipped to the ground a few times in the north-central part of Dallas) showed that the darkest cloud area eventually became associated with the funnel cloud and that the immediate cloud area associated with the dissipating tornado became lighter with time. It undoubtedly is true that the darkness beneath a cloud system is a function, among other things, of both the vertical extent and the liquid water density of the cloud system (for example, the blackness beneath the thunderstorm that everyone is familiar with, contrasted to the gray shades beneath the ordinary swelling cumulus). In the Dallas case it would seem that as the funnel cloud to the east (of the tornado) developed, so did the cloud system above it. Moreover, as the tornado dissipated, the funnel cloud increased its activity, and after passing north of the city made contact with the ground. It was followed by an aircraft and its activity was documented by a photographer aboard the plane. Perhaps another nearby cumulonimbus cell developed or increased its activity while the main tornado was active, thereby creating the funnel cloud that became a tornado. However, the funnel cloud was first photographed no later than the halfway point of the main tornado path.

Sketch 50

One and three-tenths minutes after the last sketch the funnel had retracted to the thin, slightly curved core as in sketch 50. In reaching this stage from that of sketch 49, the tip shortened from the low end upward along the tube as shown by other photographs (other tornadoes

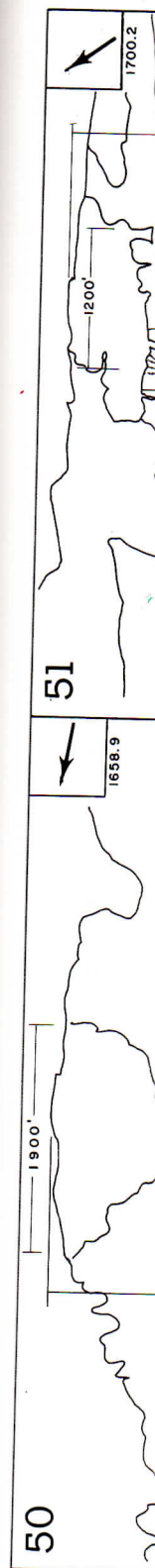

of the fun-
toward the
other part
asymmetri-
picture for
ures show-
those look-
l, yet bent
that would
as the case

ncerns the
o depended.
through the
the parent
chs having
el cloud to
eventually
the north-
the darkest
ed with the
cloud area
do became
s true that
a function,
tical extent
cloud system
ne thunder-
y, contrasted
y swelling
d seem that
e tornado)
a above it.
the funnel
ter passing
the ground.
its activity
aboard the
mulonimbus
y while the
reating the
However,
ed no later
rnado path.

er the last
o the thin,
In reaching
e tip short-
the tube as
r tornadoes

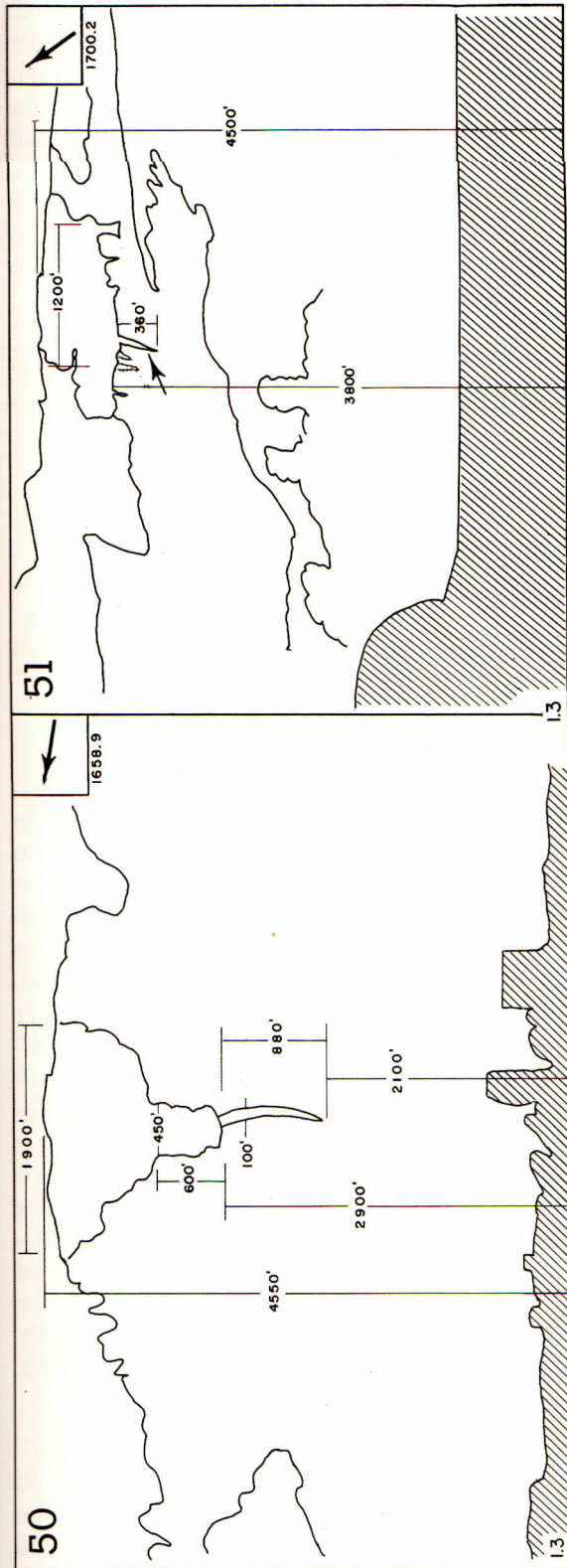

FIGURE 2.—Sketches 50-51.—The final stages before extinction of this tornado are shown.

have been known to break in the middle [5]). However, in sketch 50, the core was 880 feet long and was attached to a 600-foot-long and 450-foot-wide "hub". Above this the associated cloud was 1,900 feet in width at an elevation of 4,550 feet. The tip in this instance was 2,100 feet off the ground. The thin core was about 100 feet in diameter near the level where it joined the associated cloud. Presumably by this time there were negligible effects at the ground. A comparison, level for level, with sketch 49, shows that the entire tornado cloud system lifted. For example, the "hub" above 2,900 feet in No. 50 was almost at the same elevation as the broad, upper cloud structure in No. 49.

The direction of view was only a little north of west for this sketch.

Sketch 51

Sketch 51 (1700.2 csr) shows a 360-foot vestige of the tornado (at the arrow) depending from a small black cloud area whose width had shrunk to 1,200 feet. This portion seemed to be on the north edge of a larger dark cloud area extending from the tornado almost to the cameraman. This dark cloud area most likely was associated with the developing funnel cloud which had passed over the photographer for sketch 51, 11 minutes earlier. The width of the core remnant was about 50 feet near its associated cloud. There were some vertically alined and ragged cloud ends extending from the associated cloud or parent cloud which indicate the continuation of activity there similar to that which accompanied the tornado at earlier stages. This stage occurred 1.3 minutes after the prior photograph, and was one of the last taken of this tornado. Possibly the small black cloud associated with the tornado was observable for some minutes after this stage, but photographers would have had no interest in it, especially since a large funnel was at this time moving northward through the north part of the city and was sending a visible vortex to the ground at frequent intervals. Photographic interests were turned to this new funnel.

One of the more interesting features of this tornado was the alignment of the funnel after 1652 csr starting near mile 12 (sketch 41). Although the system was traveling in a direction a little west of north, the paths of the tip and the top did not coincide after 1652. On the map of figure 1 are shown the diverging paths with the

tip moving farther to the west of the top or the location where the funnel faired into its parent cloud. Also shown are the horizontal projections of the funnel at the times of the sketches used in the historical sequence after 1652 csr. The effect was that of the funnel traveling sideways, that is, in a direction roughly at 45° from the direction of its longitudinal axis.

The photographs showed that a funnel cloud developed to the east of this tornado and was moving along with it. The photographs also revealed

that the darkest cloud area eventually became associated with the developing funnel rather than with the active tornado. Therefore, it may be that cold air outflow from the more active cumulonimbus associated with the funnel cloud had a component to the west at low levels that pushed the tip of the tornado more and more toward the west. Photo No. 28 in the section by Beebe shows the tornado (on the left) and the tornadic bulge (on the right) at the time of sketch 49. The two systems were about 2.2 miles apart at the time.

3. THE SECOND TORNADO AT DALLAS

While the tornado that has just been described was moving northward along the west side of Dallas, a cloud bulge developed downward from the general cloud base. It was a mile east-north-east of the tornado when first photographed. The cloud bulge moved northward along with the tornado and at nearly the same speed (between 26 and 27 miles per hour). Its path (see fig. 1) was such that the east-west separation between it and the tornado increased with time so that at the time of the demise of the tornado (1701 csr) the two systems were 2¼ miles apart. Relatively few pictures were taken of the cloud bulge, and those taken early in its development were incidentally included in photographs taken of the tornado then in progress. However, later in its lifetime the cloud bulge enlarged and assumed a "threatening," tornadolike appearance [3, p. 131], and a few cameramen took notice of the bulge to the extent of taking many pictures of it. Eventually, small vortices from this tornado system momentarily contacted the ground at some points in north Dallas and several of these events were documented on still and movie film, and light debris was visible moving upward along the vortex core. The tornadic cloud system moved on north of Dallas, became a tornado, and made contact with the ground, generally in open farm country, but it damaged at least one farm dwelling. It was followed, north of Dallas, by an airplane having a professional photographer as a

passenger, and about 40 photographs were taken of the tornado from the plane.

Sketch 52

The bulge that became the tornadic cloud mentioned above was first photographed in a movie film at 1644 csr, opposite mile 8.8 of the tornado path. The bulge was estimated to extend downward only a few hundred feet below the cloud base and was somewhat smaller than the bulge that was associated with the tornado then in progress. By 1646.1 csr, 2 minutes later, (fig. 3, sketch 52) the bulge was 1,700 feet wide (across the southwest-northeast dimension) and had below it a 500-foot long, vertically alined, ragged cloud appendage of rather narrow width. The appearance of the appendage contrasted with the smooth surface of the bulge from which it extended. The tip was 1,500 feet from the ground and the vertical extent was 800 feet below the general cloud base which was at 2,400 feet at that time. Other photos showed that this bulge was almost entirely retracted by 1647.0 csr, 1 minute after sketch 52.

Sketch 53

By 1651.0 csr, a lapse of 5 minutes, sketch 53 showed that the bulge had widened to 2,000 feet across in the north-south direction. However, its lowest element at this time extended only 400 feet downward from the cloud base, just half that in



became
 er than
 may be
 e cumu-
 d had a
 t pushed
 ward the
 be shows
 lic bulge
 The two
 e time.

ere taken

oud men-
 a movie
 e tornado
 nd down-
 cloud base
 bulge that
 progress.
 sketch 52)
 the south-
 elow it a
 cloud ap-
 e appear-
 he smooth
 ded. The
 the verti-
 eral cloud
 ne. Other
 st entirely
 sketch 52.

sketch 53
 2,000 feet
 owever, its
 ly 400 feet
 alf that in

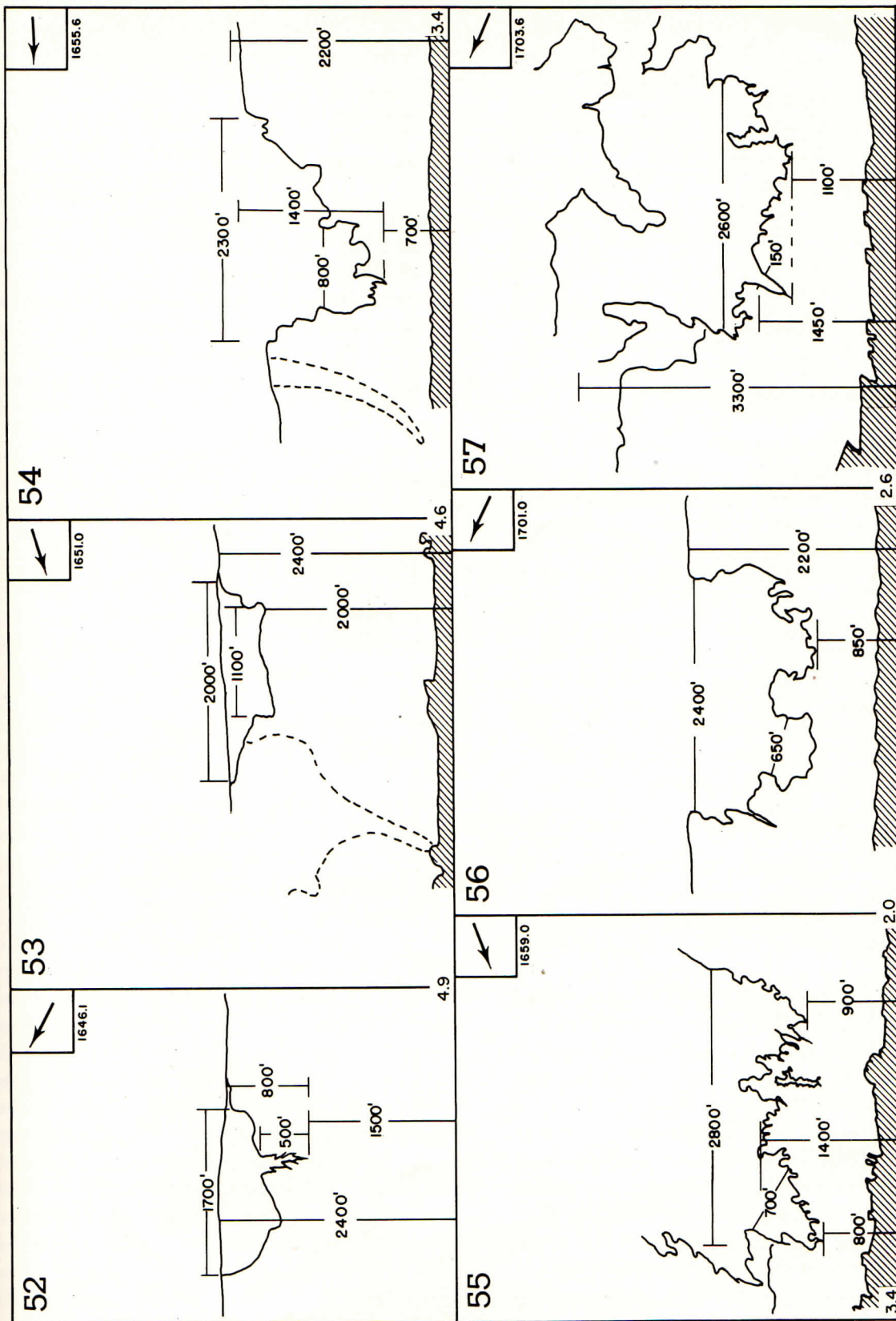

FIGURE 3.—The second tornado.—Six stages in the evolution of the tornado cloud are shown covering a period of 17.5 minutes. The size of this bulging cloud was close to that comprising the upper portion of the active tornado during about the middle third of its existence. Note the smoothly tapered vortex on the lower left side of the tornadic cloud bulge.

sketch 52; it was 2,000 feet from the ground and the ceiling was still at 2,400 feet. The direction of view for this stage had shifted toward a little south of west. The active tornado was 1.6 miles west and 0.7 mile south of the bulge at this time and its position relative to the direction of view is shown by the dashed outline.

Sketch 54

Sketch 54, 4.5 minutes later (therefore, at 1655.6 CST) showed a tremendous dimensional development of the bulge. The shape resembled that often associated with the upper portion of tornadoes, and indeed the active tornado assumed this shape at the time of sketch 20, figure 2. The top had widened to 2,300 feet in a north-south direction, and the vertical extent of the system became 1,400 feet, an increase of 1,000 feet in the 4.5 minutes. The lowest element was only 700 feet from the ground. The direction of movement was to the right in this sketch. Observe that the slope (from the vertical) of the tornadic cloud system toward the direction of movement was much shallower than that on the side away from the direction of movement, an arrangement exactly the same as that with the tornado in about the first half of its existence. The relative position of the active tornado, which was at location mile 13.3 is shown in dashed outline to the left of the bulge. The camera was pointed toward the west at the time of the photo.

Sketch 55

At 1659.0 CST, 3.5 minutes later, sketch 55 showed the funnel cloud yet larger in width and the shift of view was to the west-southwest. Whether or not the system was circular in shape in the upper portion near the cloud base is not known. This stage had two major lobes extending earthward. The one to the left (south) extended to 800 feet from the ground and was 700 feet across at the 1,400-foot level. The other was 900 feet above the ground and was somewhat similar in shape. The lobed portions in the photo had ragged edges. Other photographs taken of this by now incipient tornado, after it had moved immediately to the north of the location of sketch 55, showed a sequence where one of the two appendages (or lobes) had a smooth tapered tip (the remainder of the appendage above the tip had ragged edges) that occasionally sent a twisted

thin filament toward the ground, then retracted to a smooth tip again. Movies of the dipping sequence showed that the filament dipped and retracted in a matter of a few seconds.

Sketch 56

The view for sketch 56 changed to the west-northwest and was 2 minutes after the last sketch, bringing the time to 1701.0 CST. By this time the tornado described in the earlier section had retracted into its cloud base. Here the tornadic cloud retained the double-lobed configuration that it had in the last sketch. All of the visible edges were ragged; the long, narrow strip of cloud to the left appeared to be no more than a cloud tag. The overall width had decreased to 2,400 feet in a north-northeast—south-southwest direction, the lowest element was 850 feet from the ground, and the ceiling remained at 2,200 feet. The left appendage was 650 feet across its narrowest dimension.

Sketch 57

Sketch 57 was 2.5 minutes later, bringing the time to 1703.6 CST, and the view was toward the west-northwest as it was with the last sketch. The tornadic cloud was 2,600 feet across (in the north-northeast—south-southwest dimension) near the bottom and was 1,100 feet from the ground at the lowest point. Much of the system was ragged and torn-appearing. As was the case with the major tornado already described, the general cloud ceiling seemed to be raised in the vicinity of the tornadic cloud system. The closeness of the photographer for this sketch allowed a measurement of a ceiling of 3,300 feet adjacent to this system, yet the other photographs taken from several miles distant indicated a general cloud ceiling of around 2,200 feet to 2,400 feet. Projecting from the lower left (south) side of this cloud system was a smoothly rounded, cone-shaped form. This form had been found earlier to locate the position of the vortex. It was suggested that where cloud ends are ragged and torn there is no high-speed circular motion. This smooth cone had a tip 1,100 feet off the ground and was 150 feet in diameter at 360 feet above the tip. The distance of the photographer from the tornadic cloud system was much less, in this case, than in the last sketch.

This
velop i
the loc
airplan
its path
graph i
comple
position
broad,
bulge b
seen. T
tornado
unroofe
the airp
ground,
ing wat
that he
it dissip
One in
developi
system a
by comp
the funn
side tha
right, he
horizont

The str
where th
record de
has sugg
cloud sys
projection
associated
This idea
almost re
a tornado
was obser
from the
mediately
be aligned
nado was
pictures t
from the
the dark

This tornadic cloud system continued to develop into an active tornado some miles north of the location of sketch 57, and was followed in an airplane as mentioned earlier. However, most of its path was over open farm country. One photograph from the ground showed the tornado cloud complex at a position about 4 miles north of its position at the time of sketch 57. It showed a broad, lowered, flat-bottomed cloud base with a bulge below it, but no tornado trunk could be seen. The airplane pilot reported that after the tornado formed a few miles north of Dallas it unroofed one farmhouse. One picture taken from the airplane showed a trunk not touching the ground, much like that in sketch 15, but containing water spray near the ground. The pilot stated that he followed the tornado about 20 miles until it dissipated.

One interesting point of similarity between this developing tornadic cloud system and the cloud system associated with the tornado is illustrated by comparing sketches 20 and 54. In both cases the funnel-shaped cloud was moving toward the side that slanted most from the vertical (to the right, here), the leading edge was more nearly horizontal than the trailing edge, and moreover,

4. SHAPE AND SIZE OF CLOUD STRUCTURE ACCOMPANYING THE TORNADO

The study of certain photographs of tornadoes where the photographer was so situated as to record details of the accompanying storm clouds has suggested that some, if not all, tornado storm cloud systems are roughly circular in horizontal projection and that the cloud system immediately associated with the tornado is of limited extent. This idea was fostered by the observation that almost regardless of the direction toward which a tornado picture was taken, lighter shaded sky was observed on the side opposite the tornado from the photographer. In addition, clouds immediately surrounding the tornado appeared to be aligned in a circular pattern. The Dallas tornado was no exception. A review of the many pictures taken from many different directions from the tornado indicated a limited extent to the dark cloud surrounding the tornado and, in

the horizontal dimensions at the cloud base were nearly identical. As can be seen, both were 2,300 feet across, nearly 700 feet from the ground at the lowest point, and in both cases the ceiling was around 2,200 feet. Both had ragged edges and cloud tags. Recall that at the time of sketch 20, however, the tornado had been in existence for 14 minutes and the tornadic cloud of sketch 54 probably had just started sending a vortex streamer to the ground. This geometrical similarity may have been accidental, but the size and shape similarity is a striking one. In both cases pressure in the system was low enough to cause condensation near 700 feet from the ground. But evidently considerable difference existed between the organization of airflow in the two cloud systems being compared.

Photo No. 25 in the section by Beebe shows both the retracting tornado and the tornadic cloud (the latter on the right) at approximately 1658 cst. A circular-appearing cloud shelf is shown apparently surrounding the tornadic bulge. A following section will discuss the cloud shelves that surrounded both the active tornado and the tornadic cloud.

In addition, a few pictures strongly suggested a nearly circular shape of the lower layers around the tornado. The details of the cloud system to the west of the Dallas tornado are generally lacking since very few photographers were to the west of the path at a sufficiently great distance to record both associated cloud and funnel.

Making use of the principles of photogrammetry and perspective, the shape and size of the associated cloud system were determined and are shown in plan view on the map of figure 4, at three times, namely, at 1628.6, 1634.8, and 1650.9 cst.

Sketch 3 of the descriptive section (fig. 2) showing the tornado at 1628.6 cst, was used to determine some of the cloud structure at location-mile 1.3 along the damage path and is repeated here as figure 5. Key letters on it and the map

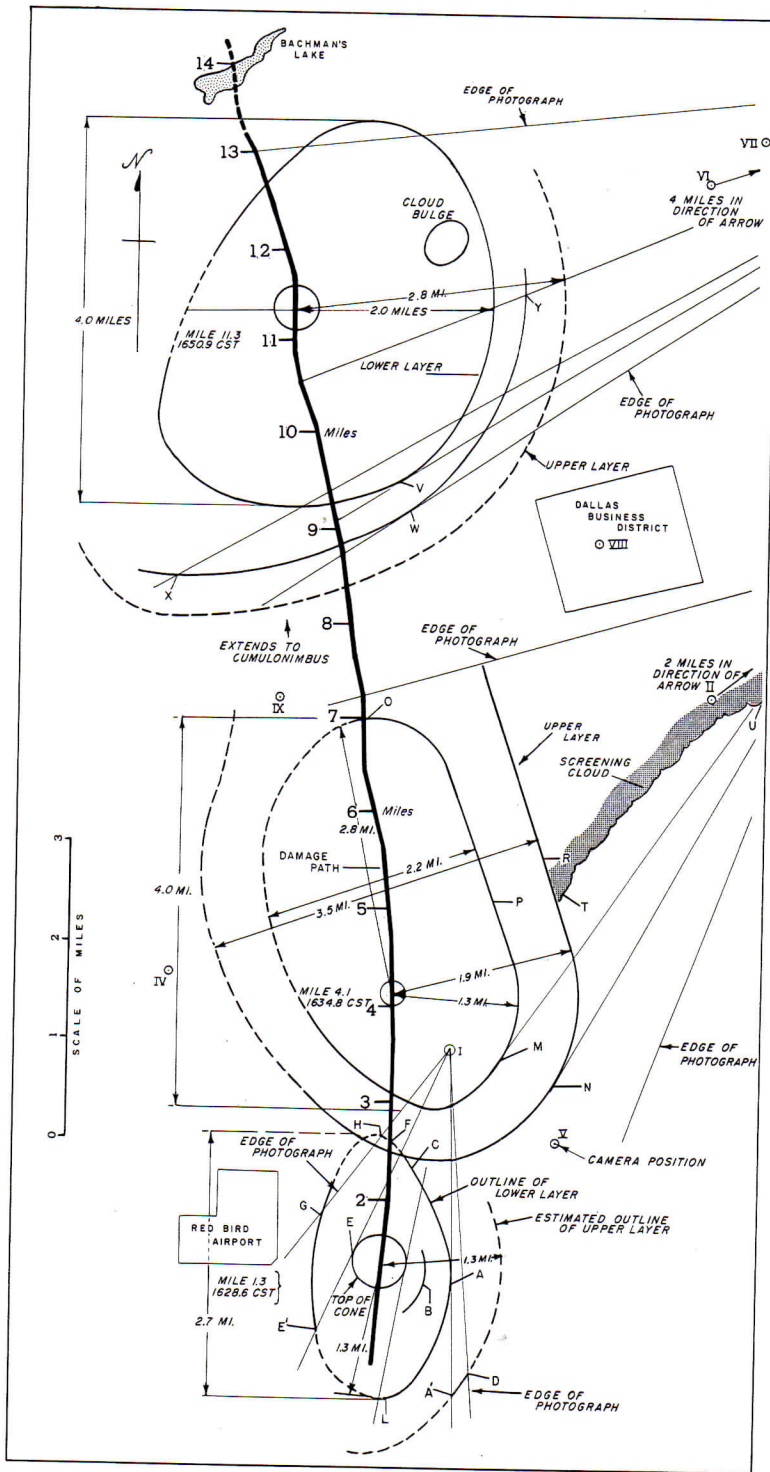

FIGURE 4.—Location and horizontal distribution of cloud layers from which the tornado extended at three times in its history, 1628.6, 1634.8, and 1650.9 cst (bottom to top of figure). The extent of the associated cloud layers increased with time. The line is dashed where the location of the perimeter was estimated. The shelf outline indicated in sketch 32 was at the time when the tornado was at location-mile 9.5, while the shelf outlined in sketch 37 was at the time when the tornado was at mile 10.8, both between the two upper portions of this sketch. That portion of the shelf outlined in sketches 32 and 37 was from east through south to southwest of the tornado. Camera positions of the photographs used in the cloud shelf synthesis are noted.



FIGURE 5.—corresponds to the sketch of figure 4.

of figure 4 on both drafts. The camera, I, was 1 mile east of the damage path. The camera position is shown in the sketch.

Generally, the photographs were stacked in the order in which the tornado was observed. The shelf follows the path of the tornado and the horizontal distance from the center of the shelf to the edge of the shelf is estimated to be 0.5 mile.

In figure 5, the edge of a shelf is shown on the map by a dashed line. The layer at the center of the shelf is shown by another shelf. The shelf is 0.5 mile wide and extends from point C, and H to the edge of the shelf.

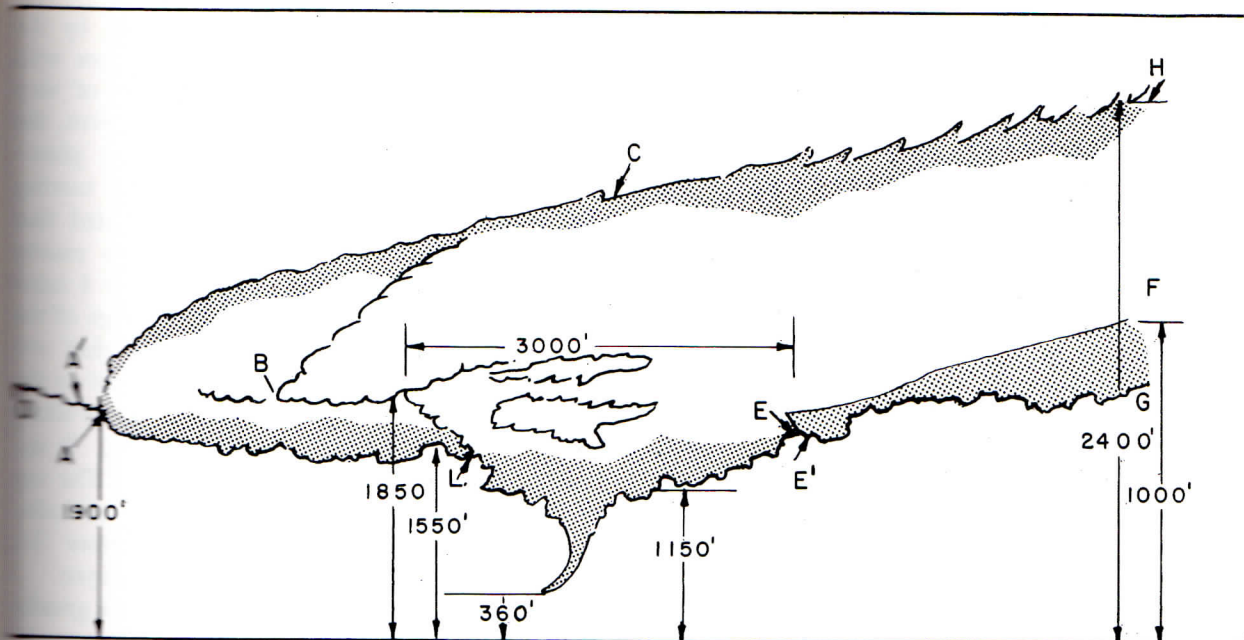

FIGURE 5.—Elevation view of tornado cloud system when tornado was at location-mile 1.3 on its path. Key letters correspond to identical positions on the lowest plan drawing of figure 4. The direction to the tornado was nearly to the south. Location of photographer was at I in figure 4.

of figure 4 allow one to locate equivalent points on both drawings. The position of the photographer, I, is shown on the map (fig. 4) at 0.6 mile east of location-mile 3.5, along the tornado path. The tornado was moving nearly toward the cameraman at the time.

Generally the scheme appeared to be, from the photographs, one in which several stratus layers were stacked above and around that part of the tornado that was visible. In the paragraph that follows the cloud system will be described and equivalent points on the elevation sketch (fig. 5) and the horizontal sketch (fig. 4) will be pointed out. In figure 4 dashed lines indicated estimated distribution of cloud perimeter.

In figure 5, the point A represents the eastern edge of a shelf of stratus cloud layer (located on the map by the same letter) which merges with the layer above it. It was 0.7 mile from the center of the tornado. Point B is the edge of another shelf nearer to the center of the tornado, 0.5 mile away from it, and which appeared not to extend around the tornado. The line along A, C, and H represents the edge of the first-mentioned shelf east and north of the tornado. The

line E'-G in the elevation sketch is assumed to be the edge of the same shelf continued around to the west of the tornado (see map) and A-L is the shelf east and south of the tornado. The sector E'-L was hidden behind the tornado and was estimated. The sector of the cloud shelf on the map (fig. 4) between G and H was beyond the right-hand edge of the picture. In the narrow sector D-A' in figures 5 and 4, the more distant edge of a higher cloud layer is shown; it is presumed to be the next higher layer which was based at 2,700 feet.⁵ On that height assumption the edge of the layer was computed to be at D-A' on the map. A point 2,700 feet high at 25° elevation (the top of the picture) from the cameraman and toward the tornado would be 1.1 mile from him. (Recall the tornado was 2.3 miles distant.) Since no light-shaded cloud appeared at the top of the picture, that is, only 1.1 mile from the cameraman, it was presumed that the upper layer extended northeast and north of the cameraman an undetermined distance (recall that the camera

⁵ A height obtained from the sketch used for the next later cloud distribution discussed in this section.

was at I). In the sector G-E' the upper layer was hidden by the edges of the lower layer so its horizontal extent could not be determined there.

The overall picture is a somewhat oval-shaped lower cloud layer 2.7 miles north-to-south and 1.4 miles in east-west extent and based at about 1,900 feet. Above this was another stratiform layer based at about 2,700 feet, whose north-south extent was unknown, but which extended over the lower layer by about 0.5 mile as shown by the dashed line. The top of the tornado cone was 0.6 mile in diameter at this time.

About 6 minutes later, another nearly simultaneous group of photographs allowed a second scaling of the distribution of these cloud layers when the tornado was at location-mile 4.1. On the map of figure 4, the cameraman from whose picture many of the measurements were taken was at position II which is off the right-hand edge of the map. Another photograph, from position IV, allowed a rough limitation of the westward extent of the cloud layers and a photograph taken at V gave the extent of the lower shelf to the southwest of the tornado and a minimum extent to the northeast of it. In addition, the height distribution of the cloud layers to the southwest and northeast of the tornado to the extremes of the photograph was determined from V. The picture from position II (fig. 6) gave the northern extent of the lower shelf and a minimum northward extent of the upper one. Again equivalent points are located by key letters on both the plan (fig. 4) and elevation sketches.

Here the width of the lower shelf cloud had increased from 1.4 miles at location-mile 1.3 to a maximum of 2.2 miles. The north-south extent of the same shelf had increased from 2.7 miles to 4.0 miles. The upper shelf was approximately 3.5 miles wide and exceeded 5 miles in length (roughly north-south). Its northward extent was indeterminate and it probably joined with the parent thunderstorm system. The tornado no longer was in the center of the oval-shaped cloud system.

One of the interesting things shown by the photograph from which the elevation view was made, was the fact that the tornado depended from a cloud whose top was at least 11,000 feet above the surface and furthermore the southeastern edge gave the appearance of being composed of stacked stratus layers along N to Q in the

elevation view. The stability indicated by the stratiform construction seems out of place with the notion that the tornado is a result of very unstable atmospheric conditions. However, the heavy shower (shown in some of the photographs), heavy wind gust, and hail moving northward ahead of the tornado, indicated that very active cumulonimbus clouds were nearby north of the tornado, with perhaps 3 or 4 miles spacing between the tornado and the edge of the thunderstorm. The screening cloud that obstructed from view the cloud development to the upper right in the elevation figure is shown along T through U in both plan and elevation. It appeared to be low-level stratus fractus. The top of the cloud system over the tornado was indistinct in the photographs and witnesses [3] claimed it merged with a higher cloud layer.

The overall picture at this stage shows a greatly enlarged cloud system accompanying the tornado at lower levels. The lower cloud shelf was 4 miles north to south and 2.2 miles wide. The upper layer was about 3.5 miles wide and again was presumed to extend to the thunderstorm system. At this stage the tornado was in the southern third of the cloud system rather than in the center as in the earlier position. The upper layer extended beyond the lower layer by 0.6 mile, just a little more than that for the earlier position. The diameter of the tornado cone at its top had shrunk to just over 0.25 mile.

A third scaling of the associated cloud system was made 16 minutes later when the tornado was at location-mile 11.3. The basic cloud distribution was made from a copy of sketch 38, redrawn here as figure 7. The photographer was at position VI so that the view was almost at right angles to the direction of movement of the tornado. The shading of the photograph from which figure 7 was made strongly suggested the circular cloud structure with stratus layers stacked one above another. The shading in the sketch is made to represent the suggestion of the photograph. A photograph taken from position VII indicated that the eastern extent of at least the upper shelf was some distance to the west of VII and a picture taken at position VIII (in the business section of Dallas) showed the upper shelf to be northwest of that location some distance. A picture taken at position IX, south of the tornado, allowed a determination of the horizontal projec-

ed by the
 place with
 it of very
 wever, the
 he photo-
 il moving
 cated that
 re nearby
 or 4 miles
 dge of the
 that ob-
 ment to the
 own along
 on. It ap-
 The top
 was indis-
 nesses [3]
 layer.
 rs a greatly
 he tornado
 elf was 4
 ide. The
 and again
 rstorm sys-
 the south-
 han in the
 upper layer
 3 mile, just
 er position.
 its top had
 ound system
 ornado was
 d distribu-
 8, redrawn
 as at posi-
 st at right
 of the tor-
 from which
 the circular
 tacked one
 tch is made
 photograph.
 I indicated
 upper shelf
 and a pic-
 usiness sec-
 shelf to be
 ce. A pic-
 he tornado,
 ntal projec-

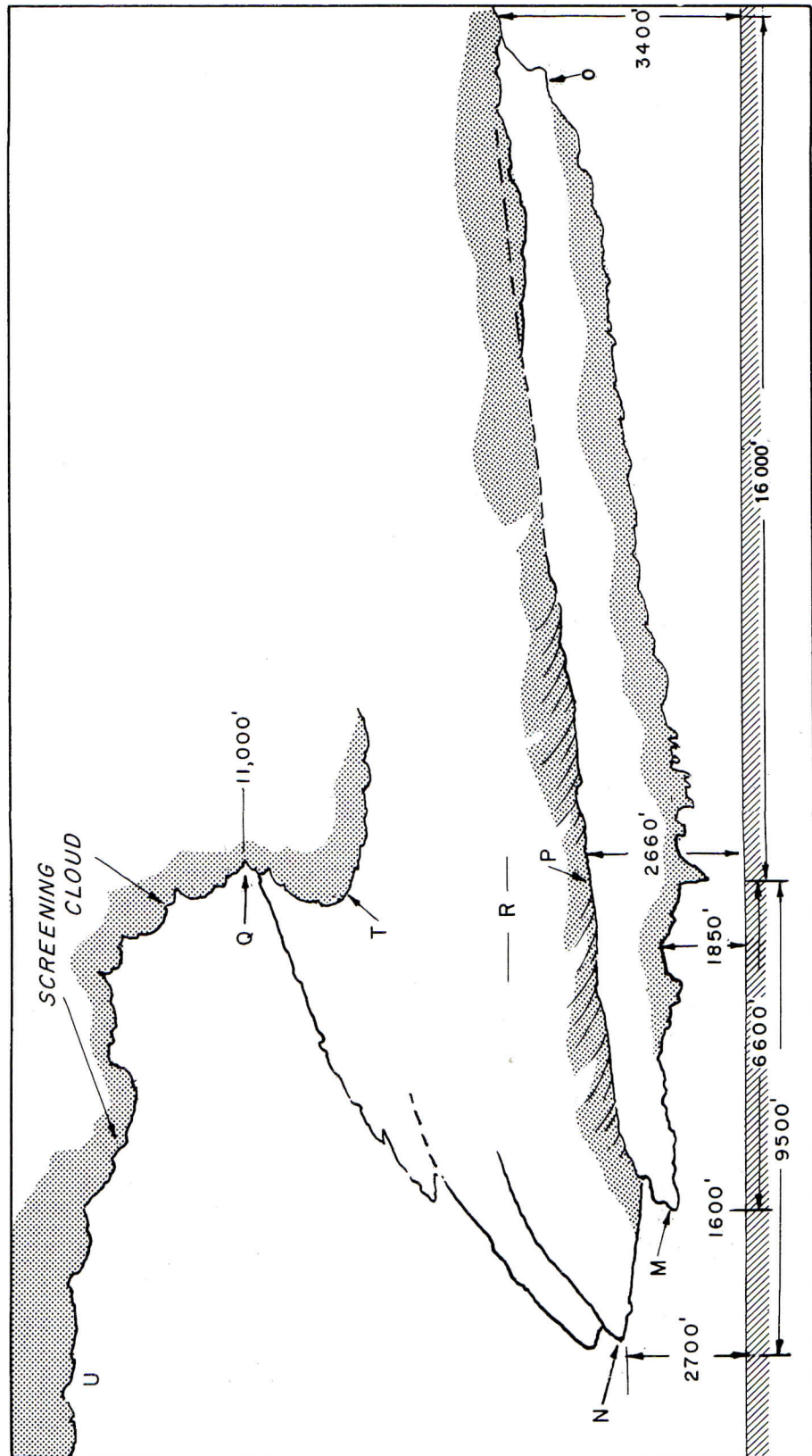

FIGURE 6.—Elevation view of tornado cloud system when tornado was at location-mile 4.1 on its path. Key letters correspond to identical positions on the center plan drawing of figure 4. The direction to the tornado was southwest. Location of photographer was at II on figure 4. Note the stacked layer effect on the left edge (southeast) of the cloud system.

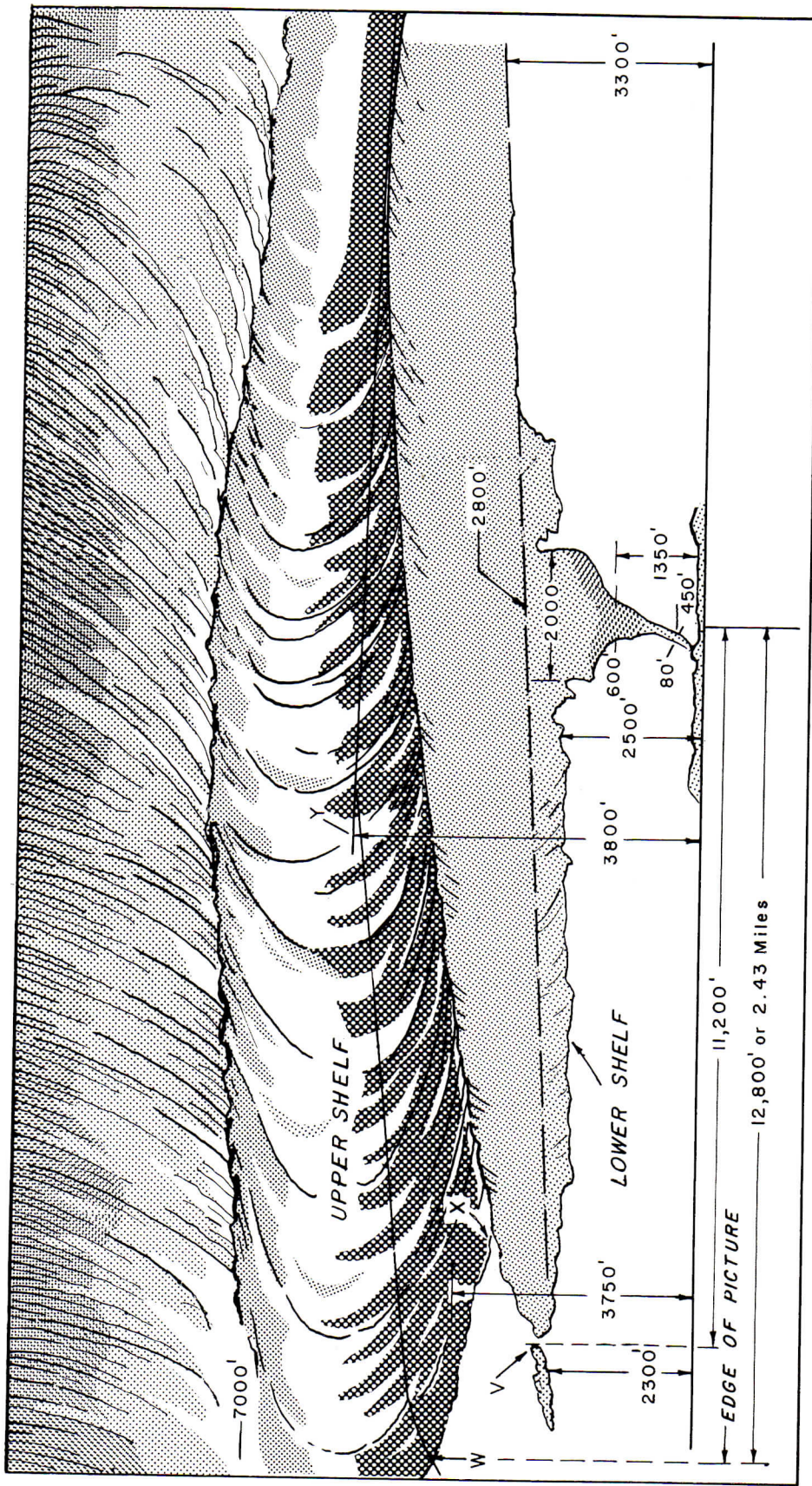

FIGURE 7.—Elevation view of tornado cloud system when tornado was at location-mile 11.3. Key letters correspond to identical positions on the upper plan drawing of figure 4. The direction to the tornado was west-southwest. Location of the photographer was at VI in figure 4. Three distinct cloud layers are indicated.

tion of the
west, thro
when it w
used for t
the tornado
graph from
tion) allo
the lower
The resul
2,300 to 2,
4 miles ac
miles from
the center
more tow

The loc
northeast
same time
located as
lower clou
of the up
suming con
western ed
location of
ever, note
the upper
horizontal
Y are at th
Consequen
tends outw
distance be
dashed out
layer exte
sketches 3
edge of the
to the sout
0.5 mile so
figure 4.

At this
building up
bulge, sinc
began to s
which at t
neously the
tensity. T
had the eff
the bulge l
As has been
mediately a
rising with
active torna

tion of the lower shelf profile from the northwest, through north, to northeast of the tornado when it was located at mile 9.1. This profile was used for that same sector of the lower shelf when the tornado was at location-mile 11.3. The photograph from position VIII (in the business section) allowed a determination of the extent of the lower shelf to the southwest of the tornado. The resultant was a lower cloud shelf that was 2,300 to 2,800 feet from the ground and was about 4 miles across from north to south and about 3.5 miles from east to west. The tornado was not in the center of the cloud system, but was located more toward the western portion.

The location of the cloud bulge, 1.6 miles east-northeast of the tornado is also shown for the same time, 1650.9 csr. Point V on figure 7 was located as the south-southeastern edge of the lower cloud deck. The point along the underside of the upper deck at X was determined by assuming constant altitude of this deck to the southwestern edge of the system and computing the location of X on the horizontal projection. However, note that point X is at the location where the upper layer starts to turn upward from its horizontal undersurface. Likewise, points W and Y are at the outer edge of the horizontal surface. Consequently, a portion of the upper layer extends outward (away from the tornado) some distance beyond X, W, and Y, indicated by the dashed outline. Hence, the outline of the upper layer extent is somewhat of an estimate. In sketches 32 and 37 the dashed line outlines the edge of the lower shelf cloud layer; the view was to the south. In sketch 37 the tornado was only 0.5 mile south of the location in the top sketch of figure 4.

At this time tornado potential was probably building up in the vicinity of the tornadic cloud bulge, since about 7 minutes after this stage it began to send a small funnel cloud downward which at times touched the ground. Simultaneously the active tornado was decreasing in intensity. The building of the tornado potential had the effect of making the cloud base around the bulge lower than that at the active tornado. As has been shown earlier, the cloud ceiling immediately around the active tornado had been rising with time. Certain pictures show both the active tornado and the tornadic cloud in pano-

rama at very nearly the same time and the cloud ceiling was considerably lower around the tornadic bulge than around the shrinking tornado (see fig. 17b).

As mentioned in the descriptive portion of this paper, the most darkly shaded cloud base area gradually transferred with time from around the tornado to around the tornadic bulge. It might be presumed that the clouds from which the tornado had descended eventually dissipated. Whatever the case, a photograph showing what was undoubtedly the cloud system associated with the once tornadic cloud turned tornado, was taken at the time when its position was estimated to be 12 miles north of the 1650.9 csr position of the once active tornado, and 3 miles east of its projected path. For the latter reason it is presumed to be the second tornado system. The system, as depicted in figure 8, was rather small. It had a 340-foot wide funnel that was 0.8 mile east of the western edge of its associated cloud system. The funnel entered the cloud base at 850 feet from the ground and the western edge (left-hand side) of the cloud system had a ceiling of 1,400 feet. The view in the picture extended 5,700 feet to the east (to the right) of the funnel and the cloud base extended to the east of that. A suggestion of another cloud base at 2,600 feet above the ground and nearly over the funnel was given by the photograph. This figure represents the northernmost location of the second tornado given by photographs known to the author. Two items of significance are evident: (a) This tornado, which is the one that was followed by the plane, and its cloud system appeared to be considerably smaller than the one that traversed Dallas, and (b) two cloud shelves can be identified above the tornado much like what was found with the earlier tornado.

The seemingly unusual situation in which a tornado extended downward from a stratiform layer has been photographed before. The author has some photographs of the cloud system attending another tornado that show the tornado apparently extending from a thick stratiform layer, with a cumulonimbus just to the north of both the tornado and the stratiform cloud layer. In addition, Reber [8] writes of seeing tornadoes and funnels extending downward from a shelf of

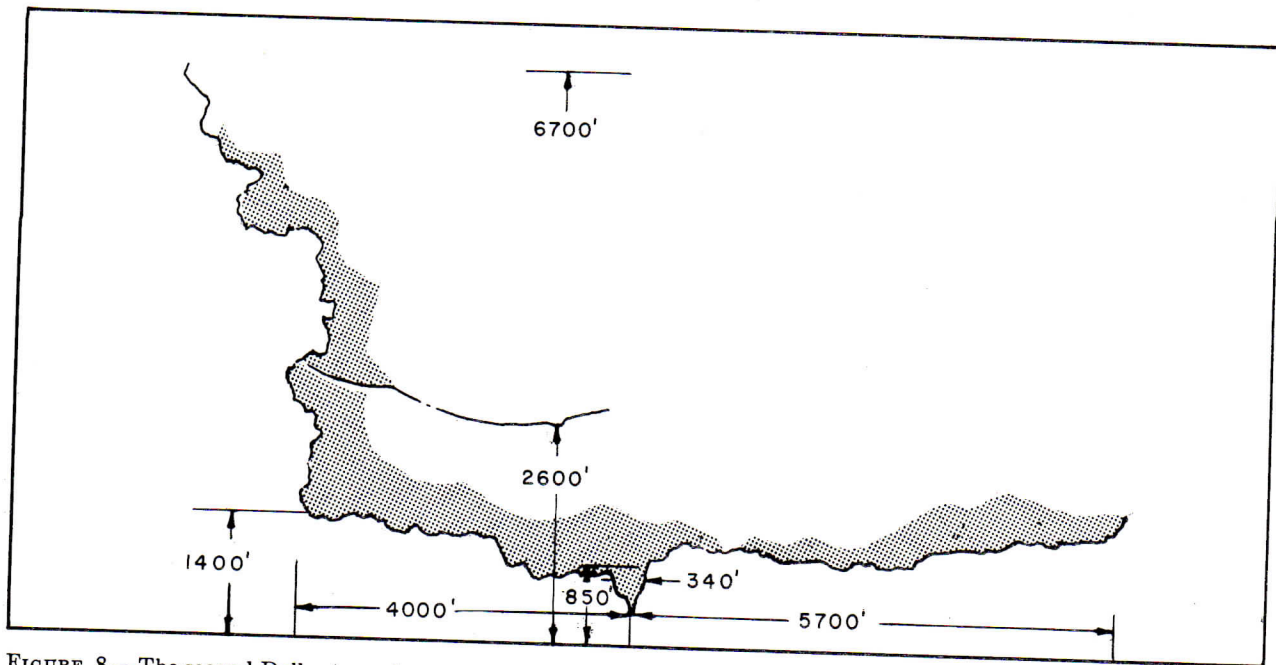

FIGURE 8.—The second Dallas tornado approximately 12 miles north of the 11.4 location-mile position of the first tornado. This tornado at this stage was small relative to the mature stage of the first tornado. Cloud shelves in the tornado cloud system were at about 1,200 feet and 2,600 feet. The tornado was less than a mile from the west edge of the cloud system. The view was to the north.

stratiform cloud that was a forward extension of the main thunderstorm cloud. The top of the shelf was clearly seen and only a few cirrus clouds appeared above it. Its base was estimated to be 4,000 to 6,000 feet and its top estimated to be no more than 12,000 feet. Reber stated further that the cloud shelf showed no outward indication of containing a violent vortex, even when the tornado was in existence. Bigler's summary [3] of interviews with eyewitnesses of the Dallas tornado stated that the top of the cloud over the tornado was not cumuliform, was very diffuse, and became larger as it moved northward and eventually joined with a thunderstorm on the north.

These observations have been mentioned to show that the tornado in at least some instances does not appear to extend downward directly from a cumulonimbus, but from a thick stratiform layer or stacked stratus layers attached to one side of the thunderstorm cloud. In light of the high degree of flexibility of the tornado vor-

tex as revealed by photographs of the Scottsbluff and Dallas tornadoes, it does not seem impossible that the vortex could have its source in the thunderstorm, bent over horizontally into the attached stratiform cloud shelf, and then bent downward to touch the ground in a vertical attitude.

In summary, this tornado appeared to extend downward from a rather localized cloud system that was most likely attached to an active thunderstorm immediately to the north of it. The localized cloud system was found to be a series of stratus layers stacked one above another. The two lowest layers were measured from photographs and their horizontal distribution was partially determined. The upper layer grew in size horizontally during the first 80 percent of the tornado's lifetime, from 2.5 to 5 miles in east-west extent, and then seemed to decrease in size. The top of the stacked stratus deck was in the neighborhood of 11,000 feet above the ground. The temperature at 11,000 feet at the time of the tornado was between $+2^{\circ}$ and $+5^{\circ}$ C., which

preclu
that le
the clo

The s
tory of
tornado
exhibit
shown i
investig
height
sistent
increase
with a
creased
at the t
variation
curve of
sudden
are two
the 1st
change o
tively ra
the 23d
25th min
to 3,200
There wa
sumption
the slight
ing to th
structive
to facilit

⁶ The height between the clouds is not shown. The idea that the clouds are not from the ground.

precludes the release of latent heat of fusion at that level for the purpose of adding energy to the cloud system. As the tornadic bulge grew

and activity increased in it, the low cloud layers extended eastward to include it as shown in the cloud-shelf outline in figure 4 at mile 11.3.

5. TIME TRENDS OF DIMENSIONAL CHARACTERISTICS OF THE DALLAS TORNADO

The series of drawings illustrating the life history of this tornado show that the height⁶ of the tornado increased with time. That tornadoes do exhibit definite time trends in height has been shown in other studies [5, 9]. Several tornadoes investigated by the author showed increased height with time and only one showed a persistent decrease and that following a persistent increase of height. The Dallas tornado started with a height of a little over 1,100 feet and increased somewhat unsteadily to about 3,800 feet at the time of its demise. A plot of its height variation with time is represented by the upper curve of figure 9a. Most of the curve is without sudden changes, but after the 26th minute there are two abrupt changes of curvature. Between the 1st and 18th minutes there was little net change of height, but thereafter there was a relatively rapid increase to 2,000 feet completed by the 23d minute. The rapid lowering during the 25th minute was followed by the sudden increase to 3,200 feet by the middle of the 29th minute. There was a slight decrease in height, then a resumption of the rise to 3,800 feet 3 minutes after the slight decrease. A mileage scale corresponding to the location of the tornado along its destructive path is drawn at the top of figure 9b to facilitate reference to the map of figure 1.

During the lifetime of the tornado there was considerable variation in the average width of the condensation funnel. The time variation is plotted as the lower curve of figure 9a. The magnitudes of the variations were nearly as great as those of the tornado height up to the 18th minute and these variations amounted to 300 feet of aver-

age diameter change. After the 18th minute the variations of the funnel height exceeded those of the average width.

In studies of other tornadoes it was noticed that the height and the average width displayed certain interrelationships. For example, the height and width would increase or decrease simultaneously, or one would decrease while the other increased. These in-phase and out-of-phase relationships were exhibited by the Dallas tornado. In figure 9a it will be noted that between the first and fourth minutes⁷ the out-of-phase characteristic was displayed; that is, with a decrease of height the width increased, and vice versa. A correlation coefficient of -0.98 between this portion of these curves indicated the definite inverse relationship. The relationship between the two curves from the 8th to the 10th minutes was indefinite. After the 10th minute and until the 26th minute a definite in-phase characteristic prevailed. A correlation coefficient of $+0.74$ shows the fairly close relationship between this portion of the two curves. From the middle of the 26th minute to the 30th minute, the relationship was in-phase, but the similarity of curvature shown by the portion after the 10th minute was not retained. However, a correlation coefficient of $+0.97$ reveals a very close positive relationship. After the 31st minute the relationship was again out-of-phase, and the relative closeness of the inverse relationship is shown by a correlation coefficient of -0.78 .

The time trend characteristic of the tip height above the ground is another feature that varies among tornadoes. For example, some tornado tips show a tendency for definite periodicities in their dipping up and down; some descend to the ground and remain there until the end of the tor-

⁶ The height of the tornado as used here is the vertical distance between the ground and the level at which the tornado fails into the associated cloud above it. This is based on the idea that as soon as a condensation funnel starts downward from the cloud there is rotary motion all the way to the ground.

⁷ Between minutes 3.6 and 8.0 the funnel retracted so no width measurement was possible.

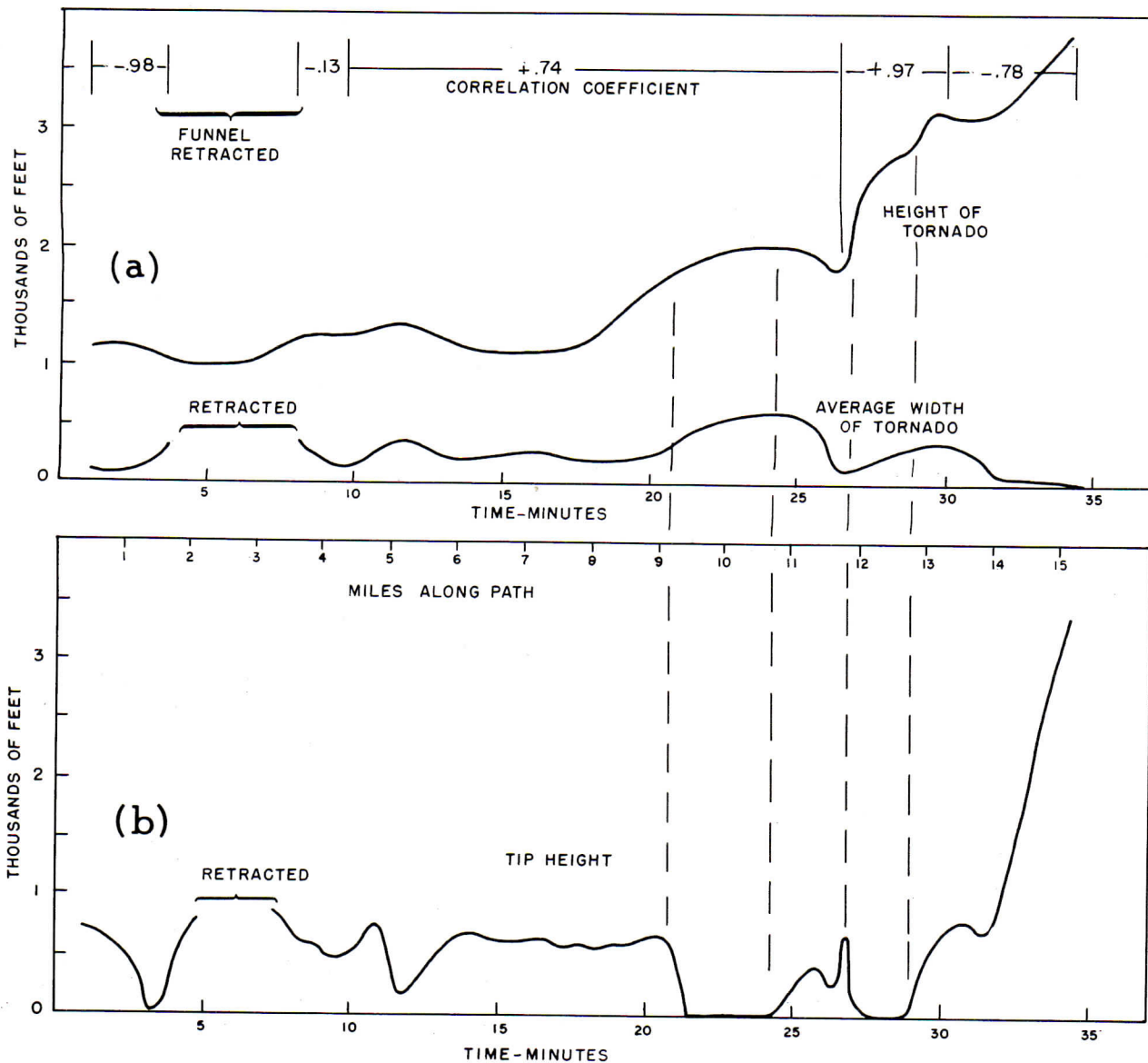

FIGURE 9.—(a) Graph of time change of tornado height and average width. On the average, height increased with time. Correlation coefficients between height and average width are shown for those portions that are similar or dissimilar in time-trend characteristics. (b) Graph of time-trend of tip height. Note the small percentage of time tornado trunk was touching the ground.

nado, while others skip along with only short-period ground contacts. The time variations of the tip height for the Dallas tornado are shown in figure 9b. Many of the tip height variations were very abrupt, yet in some periods, such as between the 14th and 21st minutes, the tip height was steady. The tip started from a height of 750 feet, underwent large variations in height,

was on the ground three times, and finally retracted rapidly to a height of 3,400 feet after its last ground contact. Altogether the time on the ground was 4.2 minutes, or a little over 12 percent of the total time. Two minutes after the first photograph that detected the tornado, the tip was on the ground and remained there about 0.2 minute.

Sketches
thin 45-foot
rose to a
at which t
as could b
funnel wa
the sevent
the ground
utes with a
middle of
middle of
of the tip
the previo
bulge-shap
lifted leavi
idly rotatin
ing descen
attained a
tween min
it stayed th
this ground
classical ele
part of the
minute it r
again whip
43 for this
amounted t
nado had in
photograph
after havin
the tip lift
occurred at
This was f
feet by the
tornado cea
In a deter
of the tip o
there was a
dip less fre
of these per
large torna
ones. The
had an aver
During th
were increas
and 24th m
overall size,
tip, after th
size, sudden
remained ther
considered t

Sketches 4 through 7 of figure 2 show only a thin 45-foot-wide tube touching the ground. It rose to a little over 800 feet by the fifth minute at which time the funnel ceased to exist as nearly as could be determined from the photographs. A funnel was again in existence by the middle of the seventh minute with its tip at 850 feet above the ground. The tip dipped in the next 6 minutes with amplitudes of up to 600 feet. From the middle of the 13th minute (sketch 19) until the middle of the 20th minute (sketch 30) the height of the tip remained very steady compared with the previous actions. During this period the bulge-shaped cloud just above the tip gradually lifted leaving a smooth-surfaced, apparently rapidly rotating condensation tornado cloud. Starting descent to the ground at minute 20.6, the tip attained a vertical speed of 14 miles per hour between minutes 21.0 and 21.4. Once on the ground it stayed there for nearly 3 minutes. It was during this ground contact that the tornado assumed the classical elephant-trunk shape. Between the early part of the 24th minute and the middle of the 27th minute it rose unsteadily to nearly 700 feet, then again whipped to the ground (see sketches 40-43 for this stage). Its contact duration this time amounted to 1.2 minutes. At this time the tornado had increased in size and appeared from the photographs (sketches 44-46) to be reviving after having been in a weaker stage. After that the tip lifted rapidly to 800 feet then a pause occurred at minute 31.5 with a very slight dip. This was followed by a very rapid rise to 3,400 feet by the middle of the 34th minute when the tornado ceased to exist.

In a determination of the average dipping cycle of the tip of a few tornadoes, it was found that there was a tendency for the larger tornadoes to dip less frequently than the smaller ones. Some of these periods ranged from 8.5 minutes for the large tornadoes to 1.2 minutes for the smaller ones. The intermediately sized Dallas tornado had an average period of 5.7 minutes.

During the period when the height and width were increasing together, that is, between the 18th and 24th minutes, the tornado was growing in overall size; near the end of the 21st minute the tip, after the height and width reached a certain size, suddenly descended to the ground and remained there for a few minutes. These factors considered together, it seems, could be taken to

indicate an increase in the intensity of the tornado. Note that the period when the tip remained solidly on the ground (from minute 21.4 to 24.2) coincided with the simultaneous increase of funnel height and width. Just after the lifting of the tip early in the 24th minute the funnel height and width rapidly decreased and the tip did not descend again until the height and width were again increasing. Curiously enough the tip lifted again at minute 28.9, just as the width increase was leveling off and the height increase rate had slackened. This seems indicative of slackening energy expenditure near minute 28.9. This scheme of increasing height and width associated with the descending tip, and its attachment to the ground (and the converse), does not explain the brief dip to the ground of the tip at minute 3.2, nor the partial dips at minutes 26.4 and 31.5. Apparently the scheme mentioned above was a characteristic of this particular tornado, since the second Scottsbluff tornado [5] increased its height and decreased its width while maintaining its tip on the ground until its demise. It seems as though it was necessary for the height and width to be increasing simultaneously before this tornado could send its tip to the ground.

Another portion of the curves that seems to follow the scheme suggested above, is that between minutes 10.7 and 17.0. The tip descended part way to the ground while the height and width were increasing slightly between minutes 10.7 and 11.6; then the tip rose when the height and width were decreasing a little between minutes 11.6 and 14.0. From there until minute 17.0, when the height and width were steady, there was little change in the tip height. From minute 17.0 to 20.6, the height rose and the width decreased a little, but the tip was essentially steady. This could be taken to indicate no change in power output.

In this section it has been shown that there were periods in the lifetime of this tornado when definite relationships existed between the height and average width of the funnel; also periods when definite relationships existed between height, width, and tip height taken together. There are some indications in a qualitative sense that power expended by the tornado against its environment can be related to funnel height and average width and the height above ground and movement of the funnel tip all taken together.

6. THE SEGMENTED TIP AND DOUBLE-TUBE CONSTRUCTION

Some of the more interesting phenomena of the condensation funnel of this and other tornadoes, such as the hollow tube and double- or multiple-tube construction, have been discussed in the first section of this paper. Another interesting phenomenon, seen for the first time in photographs of the Dallas tornado, was the segmented tip section. The tornado was near location-mile 11.5 and was rising off the ground after going through the elephant-trunk phase when a photograph was taken showing the segmented tip section and the double-tube construction. In this section of the paper the lowest 380 feet of the tip are discussed and the scaled drawing of this picture is displayed as figure 10.

The first item of interest shown in the sketch is the indication of a double cylinder construction at the tip of the funnel. The outer tube or sleeve was 40 feet in diameter at its terminus and from it protruded a tube a little over 60 feet long and about 15 feet in diameter at its maximum. The ratio of the tube diameters was 2.7 to 1. By way of comparison, the Scottsbluff tornadoes [5] produced tube ratios at various times of 3.13:1, 2.65:1, and 2.00:1, but averaged 2.60:1. Kan-geiser [7] constructed a mathematical model of a vortex having concentric condensation sleeves whose diameter ratio was 2.85:1.

The second item of interest was the segmentation of that portion of the tip that consisted of the inner sleeve and which extended downward 230 feet from the end of the outer tube. This phenomenon had never before been seen by the author in any other tornado photograph. Its existence was revealed undoubtedly by the nearness of the cameraman (0.22 mile) and the judicious use of a good camera at the right time. The inner sleeve extending from the larger one actually had the appearance of having had a slight constriction about 15 feet below the end of the outer sleeve; this constriction possibly was analogous to the absence of condensation that existed between the segments. These segments were not of the same length or the same shape. However, they are suggestive of a sort of standing pressure wave. There is no means of knowing whether

or not they were traveling longitudinally along the core of the tornado or were stationary. The lowest segment was nearly spherical in appearance but had a thin tail attached to it extending downward and to the left (the south). This tail was approximately 3 feet in diameter and the upper portion was about 20 feet across.

Since the pressure in any portion of the condensation funnel can be considered to be at or below the condensation pressure of the environmental air, these segments are presumed to have been in regions of pressure equal to or lower than the condensation pressure of the surrounding air. Therefore, the regions between them are regions of higher than condensation pressure. This fluctuation

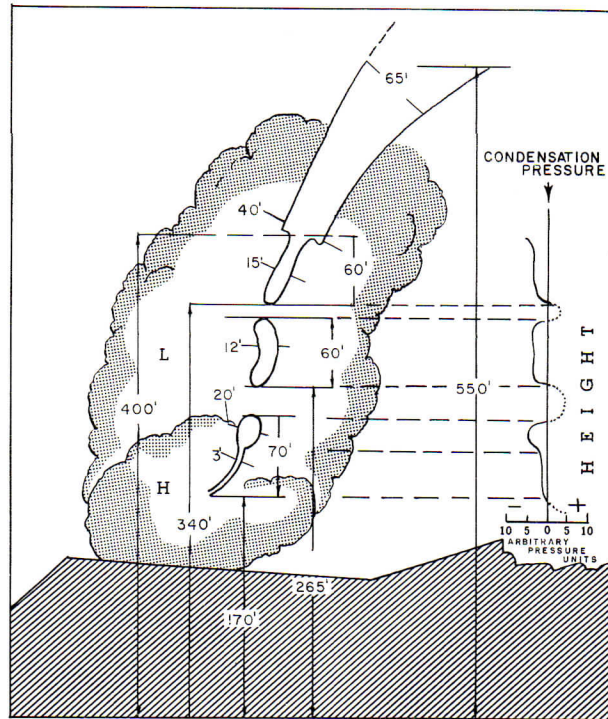

FIGURE 10.—Segmented and double-sleeved tip section of one stage of the Dallas tornado. On the right is a schematic diagram of probable pressure distribution along the segmented tip referenced to the condensation pressure. Tornado was near location-mile 11.5.

tuation
dinary
somewh
along t
this cas
was pro
tributio
should
right si
Other

Durin
between
the efflu
photogr
four di
these ph
mine th
plume v
ment of
the airfl
distance

A fir
the sm
gives th
the smol
22 thro
in front
between
changes

Since
the plu
northeas
point, a
wind to
corded a
other fo
east win
of the sr
were pro
pose of
and exte
flow in t

In ord
plume an
tornado

tuation of pressure along the core seems extraordinary because one would intuitively think of a somewhat linear decrease of pressure upward along the tornado core from the ground. If, in this case, the diameter of the condensation core was proportional to the central pressure, the distribution of pressure along the segmented tube should look somewhat like the plot along the right side of figure 10.

Other tornado photographs have shown that

the tornado condensation tube sometimes breaks near the midportion of the tube (between parent cloud and ground); the break undoubtedly means that the condensation pressure was exceeded at that point.

The possibility that pressure varies somewhat abruptly along the tube on a small scale suggests that the same thing could occur with larger amplitudes and might explain the large bulges seen on some tornado trunks.

7. INFLUENCE OF THE TORNADO ON THE SURROUNDING AIR

During the time that the tornado was passing between location-miles 7.5 and 10.1 (see fig. 1) the effluent from a cement plant smokestack was photographed simultaneously with the tornado by four different cameramen. The distribution of these photographs has made it possible to determine the movement of elements of the smoke plume within certain limits. Hence, the movement of the effluent has been used as a tracer of the airflow in the vicinity of the tornado from a distance of about 0.3 to 1.2 miles from its center.

A first inspection of the photographs, showing the smoke plume and tornado simultaneously, gives the impression that the tornado influenced the smoke plume very little. Particularly sketches 22 through 27 show the tornado moving past and in front of the smoke plume at a distance varying between 0.3 and 0.8 miles with no obvious major changes in the appearance of the plume.

Since the tornado intercepted the smoke plume, the plume was required to travel toward the northeast to reach the tornado at the intersection point, and this in the face of a steady ambient wind toward the northwest (southeast wind recorded at Dallas Weather Bureau Office). Clearly other forces than those responsible for the southeast wind were acting on the air in the vicinity of the smokestack. Undoubtedly the other forces were provided by the tornado system. The purpose of this section is to determine the amount and extent of the effect of the tornado on the airflow in the smokestack area.

In order to compare the motion of the smoke plume and its elements during the passage of the tornado past the smokestack, figure 11 was con-

structed. Only the smoke plume and the tornado centerline were extracted from sketches 22 through 27, and arranged in the form of a distance-time diagram. In the diagram, distance increases to the right and time increases upward. The vertical distance between the baselines of the sketches is proportional to the time difference between them, shown at the right of each sketch. Inspection of figure 11 shows that three prominent vertical puffs of smoke moved to the right (northeast) with time and, moreover, preserved their identity during the period. Evidently there was insufficient turbulence or shear present to break up these smoke puffs. Unfortunately, in sketch 22, a portion of the smoke plume was off the right-hand edge of the picture. In the figure the center of each puff was estimated and a perpendicular was dropped from the center to the baseline. The points of intersection of these perpendiculars with the baseline have been connected to indicate the relative movement and speed of each puff between sketches.

Of interest was the change of character of the plume a short time before sketch 22. Evidently conditions around the stack before the time of sketch 22 favored the formation of the high, vertical puffs; immediately afterward conditions were unfavorable for tall puffs and allowed only small ones at best. The tall puffs resembled closely the condition termed "looping" by micro-meteorologists [6]; looping is caused by a steep lapse rate and low wind speed. On the other hand the low-lying neck of smoke connecting the stack with the tall puffs is very much like "coning" which indicates moderate lapse and a greater

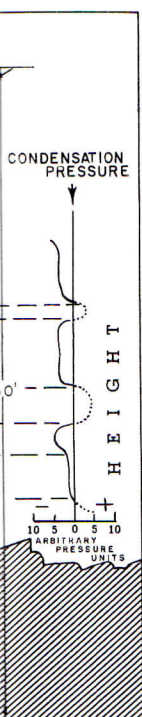

tip section
n the right is
e distribution
condensation
le 11.5.

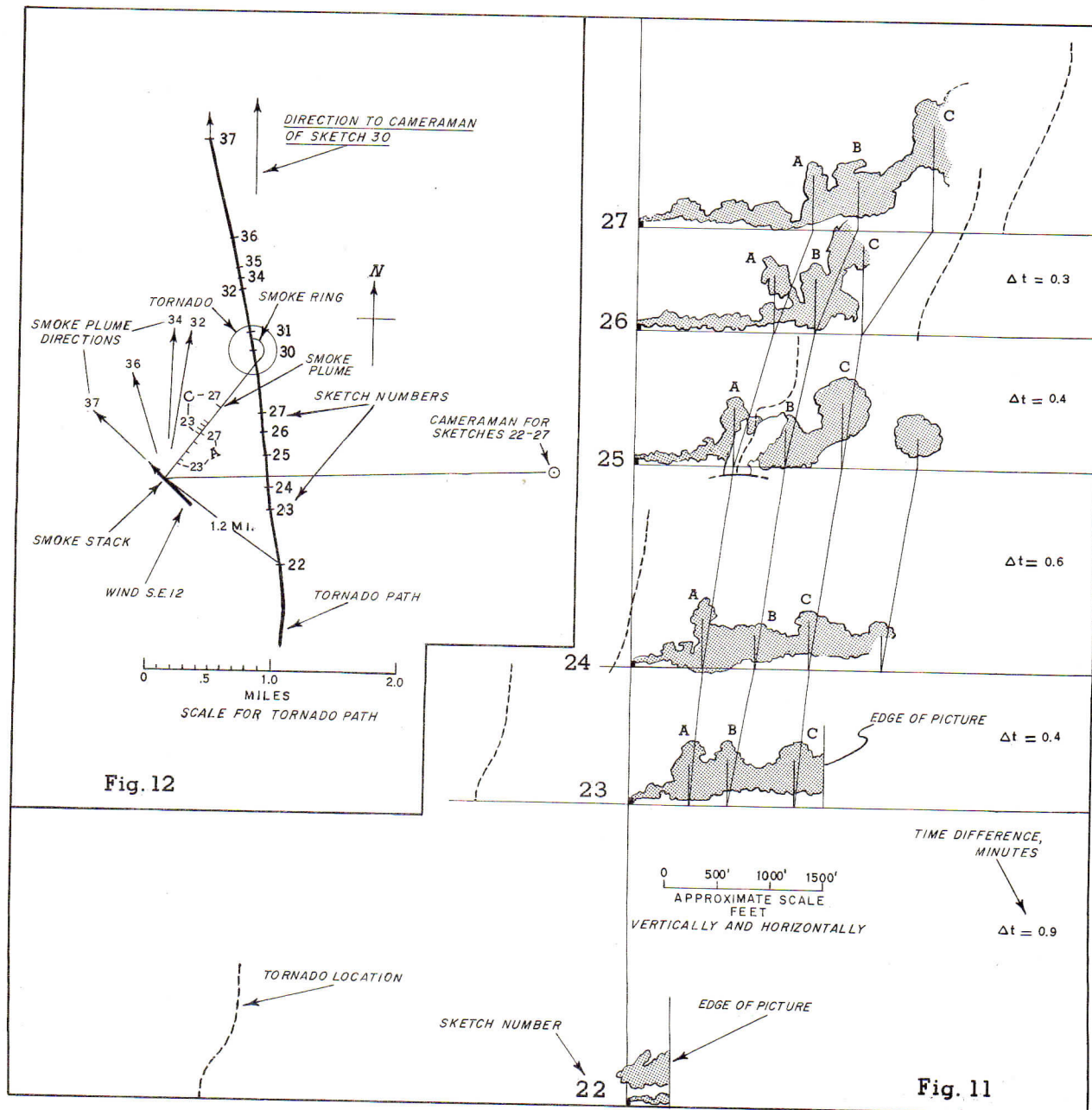

FIGURE 11.—Distance-time diagram of the smoke plume with relative tornado locations shown by dashed lines. Distance increases to the right (the north) and time increases upward. Puffs that maintained their identity throughout the series are labeled A, B, C. The time difference to the next sketch is shown at the right-hand side of each section. Slanted lines connected to the perpendiculars in the puff centers give an indication of speed of puffs between sketches. The drawings were extracted from sketches 22 through 27 of figure 2.

FIGURE 12.—Map of tornado path in the vicinity of the smokestack showing smoke plume directions, smoke puff locations, ambient wind vector, and location of tornado at times of sketches 22 through 37. Arrows leading out from the smokestack having sketch Nos. 32 through 37 at their tips show the estimated direction of the smoke plume at the time the tornado was at locations on its path corresponding to those sketch numbers.

wind speed of the air suddenly from reason for plume mobility is zero to a makes low shown for row neck right from also a m from the narrow r configura the wind component started to north) and onward. the sum of

The speed B, and C figure 11 are identical. In this figure bottoms of letters show the sketch proportion increased time represented increase in C. Puff between very near. The tops tical motion tained. T at nearly puff C movements were of the vertical in a However, and 26, as tions of puff than the and 27, h action app

wind speed. It seems unlikely that the lapse rate of the air near the smokestack would change suddenly from steep lapse to moderate lapse; another reason for the change of character of the smoke plume must have occurred. A most obvious possibility is the change in wind speed from nearly zero to a definite and continuous movement. This makes logical also the formation of the plume as shown for sketch 22. This sketch shows the narrow neck of smoke which had been moving to the right from the stack at the time of sketch 22, but also a much taller puff extending over the stack from the right and probably connected with the narrow neck off the picture to the right. The configuration of the smoke plume indicates that the wind had been moving from the right (component to the south), then just prior to sketch 22 started to move from the left (component to the north) and continued to do so from that time onward. Hence, a short time before sketch 22, the sum of forces on the air at the stack was zero.

The speed of the three smoke puffs, labeled A, B, and C, was not the same, as an inspection of figure 11 will show (the sketch numbers in fig. 11 are identical to those of the sketches in fig. 2). In this figure the slope of the lines connecting the bottoms of the perpendiculars from the puff centers shows the average speed of the puff between the sketches since the distance between sketches is proportional to the time between them. Puff A increased its speed in every interval during the time represented by the figure. Puff B did not increase its speed in every interval, nor did puff C. Puff C took a rather sudden jump in speed between sketches 26 and 27, after maintaining very nearly the same speed from sketches 23 to 26. The tops of these puffs were used to measure vertical motions of the air in which they were contained. The top of puff A, for example, remained at nearly the same height during the period, while puff C moved upward. Other differential movements were indicated by the change in attitude of the vertical puffs. They remained nearly vertical in attitude between sketches 23 and 25. However, shear was evident between sketches 25 and 26, as shown by the fact that the lower portions of puffs A and B moved farther to the right than the top portions did. Between sketches 26 and 27, however, the effect of the last described action appeared to be largely removed, since puff

A was again vertical, and puff C was elongated upward and to the right by the time of sketch 27.

In order to clarify the movement of the plume, the puffs, the tornado, the direction of the ambient wind, and the locations of puffs A and C at the time of the sketches, figure 12 was constructed. Along the tornado path are the sketch numbers corresponding to the sketches of figure 11 (as well as of fig. 2) locating the tornado at the time of the sketches. Along the plume from the stack to the tornado are the locations of puffs A and C at the times of the sketches of figure 11 and figure 2. Also are shown the directions taken by the plume as it swung counterclockwise toward the ambient wind direction between the times of sketches 32 and 37, and the direction of the ambient wind.

As mentioned earlier, the smoke plume was nearly at a standstill just before the time of sketch 22, which indicates that the sum of all forces at that time on the air in the vicinity of the smokestack was nearly zero. Evidently the pressure force of the ambient wind was balanced by that of the micro-Low containing the tornado. Hence the influence of the tornado extended considerably farther than the 1.2 miles between its location, at the time of sketch 22, and the smokestack.

By scaling the sketches of figure 11 and knowing the time between sketches, the average speed between sketches was computed for the smoke puffs. A plot of these average speeds against time allowed some estimation of the speed at the time of the sketches. The direction of the puffs was assumed to be from 215° during the entire time under investigation, because this was the direction from the stack to the intersection position with the tornado, and photographs indicate that this was the most likely direction. For example, sketch 30 shows the smoke plume extending from its source to the tornado, and figure 12 shows the 215° direction taken by the plume to intersect the tornado at the radius of the smoke ring as measured at that time. By taking the vector difference between the velocity of the puff at the time of each sketch, and the vector sum of the ambient wind velocity and tornado translation velocity, the velocity of the wind relative to the tornado center (tornado relative wind vector) was obtained. The method is illustrated in figure 13.

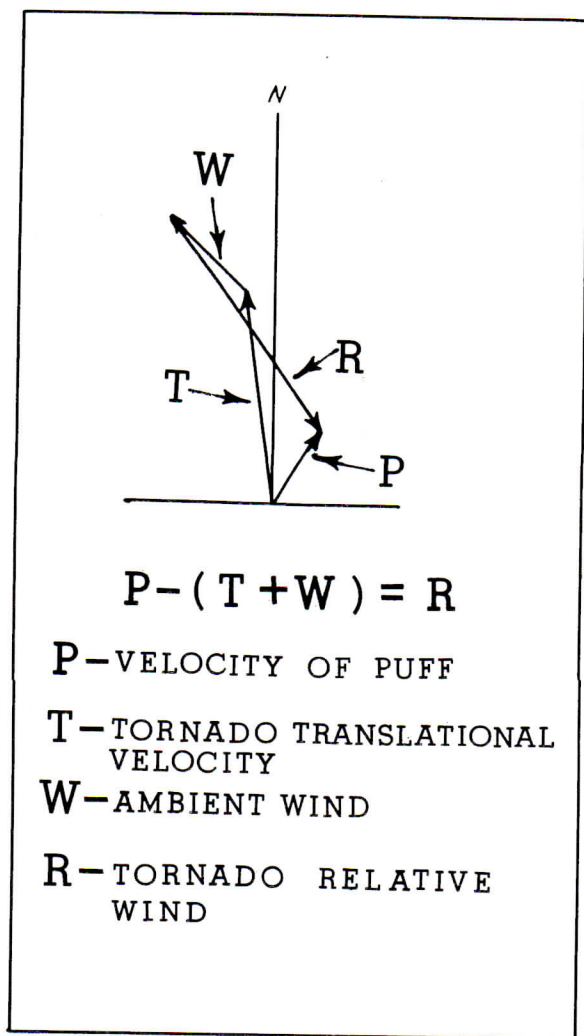

FIGURE 13.—Method of deriving tornado relative wind vector **R**, from local wind **P**, ambient wind **W**, and tornado translational velocity **T**.

Each tornado relative wind vector was plotted at the position of the puff relative to the tornado at the time of the speed determination. The result is as shown in figure 14 where arrow length is proportional to the wind speed. All vectors show a strong inward (radial) component of wind and it is to be recalled that these determinations were made for tracers that were between 500 and 1,300 feet above the ground. Note that there is little variation in the total horizontal speed of the wind among these vectors which varies from 29 to 35 miles per hour.

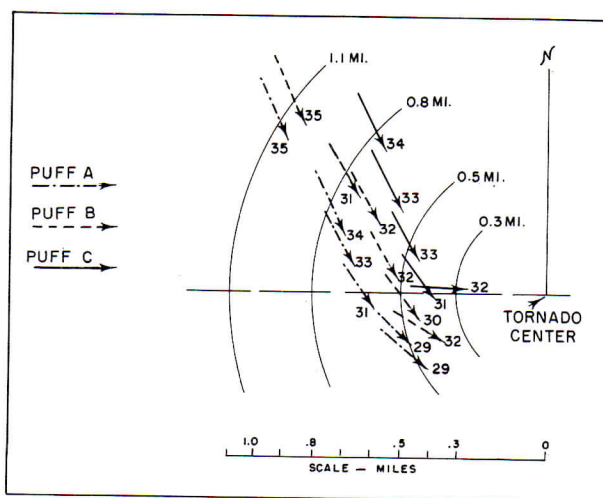

FIGURE 14.—Direction and speed of derived tornado relative wind as determined by movement of smoke puffs. Arrow length is proportional to speed of wind. Location of observation is at center of arrow.

Since each puff of smoke presumably represented a unique parcel of air, the wind vectors should have been tangent to a line (that is, the trajectory) connecting the puff location points for each speed determination. Examination of figure 14 shows that the vector directions were not exactly tangent to the trajectories of the smoke puffs. Particularly, puff C vectors all point inward from a line connecting the location points. Since errors may have entered in the graphical method of determining these vectors and their locations, smoothed lines were drawn through the location points for each puff, and vector directions were adjusted to be tangent to these smoothed lines; the speeds were retained as originally determined. The smoothed vectors were plotted in figure 15a to show the angle at which they crossed their radial lines. Each vector was positioned outward from the center, at a distance proportional to the distance from the tornado center. Puffs A and B show an increasing angle to the radial with decreasing distance from the tornado center, indicating increasing tangential components with a decrease of radius. Puff C shows little variation of the vector angle with decrease of radius.

The speed of the storm at a later time... time of... to swing... nado was... the position... estimated... ent wind... correct po... of the plu... 12 shows... the sketch... formation... influenced... the time o... by the sm...

Another... the tornado path, 13... smokestack... 0.86 mile... port Stati... tornado or... strument v... of figure... wind direc... tion) reco... weather st... south unti... arrived at... west of the... to southwe... remained... had just p... csr. The... the tornad... tion, was n... circulation... station the... later to sc... the tornad... the tornad... hour while... to south, h... hour. Ha... at the wea... the ambien... tornado pa...

⁸ The triple... the lower the... speed determin...

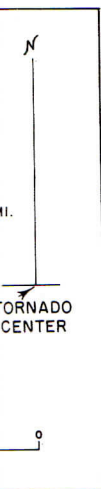

d tornado
of smoke
d of wind.

ly repre-
d vectors
at is, the
on points
nation of
ons were
es of the
ectors all
e location
ed in the
se vectors
re drawn
puff, and
ngent to
etained as
d vectors
e angle at
ach vector
ater, at a
from the
n increas-
g distance
increasing
of radius.
ctor angle

The speed and exact direction of the elements of the smoke plume were not obtainable at any later time, but it is known that shortly after the time of sketch 30 (see fig. 12) the plume began to swing counterclockwise with time. The tornado was 2.7 miles away from the smokestack at the position of sketch 37 when the plume was estimated to have taken the direction of the ambient wind. However, there were no pictures in the correct position to determine the exact direction of the plume after the time of sketch 30. Figure 12 shows the estimated plume direction shift and the sketch numbers from which the direction information was obtained. Evidently the tornado influenced an area nearly 2.7 miles in radius at the time of the observation in the layer occupied by the smoke plume.

Another opportunity occurred for determining the tornado-wind near the end of the tornado path, 13 minutes after the tornado passed the smokestack. The tip of the tornado passed only 0.86 mile to the west of the Weather Bureau Airport Station at Dallas, and some effect of the tornado on the station's self-recording wind instrument was looked for. From an examination of figure 16, the minute-by-minute autographic wind direction and speed (as well as precipitation) record⁸ it is evident that the wind at the weather station was variable from southeast or south until 1653 cst at which time the tornado arrived at a position 1.6 miles south and a little west of the station; at that time the wind shifted to southwest and a minute later to northwest. It remained from the northwest until the tornado had just passed the station to the west at 1656.5 cst. The northwest direction of the wind, while the tornado was southwest and west of the station, was not consistent with the cyclonic tornado circulation. Just after the tornado passed the station the wind shifted to south and a minute later to southwest. This seems consistent with the tornado circulation until one considers that the tornado was moving at nearly 27 miles per hour while the southerly wind, upon first shifting to south, had a speed of only about 11 miles per hour. Had tornado-wind influence been present at the weather station it should have augmented the ambient southerly wind during and after the tornado passage. It is concluded that the wind

⁸ The triple-register records every mile of wind passage, so the lower the wind speed the greater the time over which the speed determination is averaged.

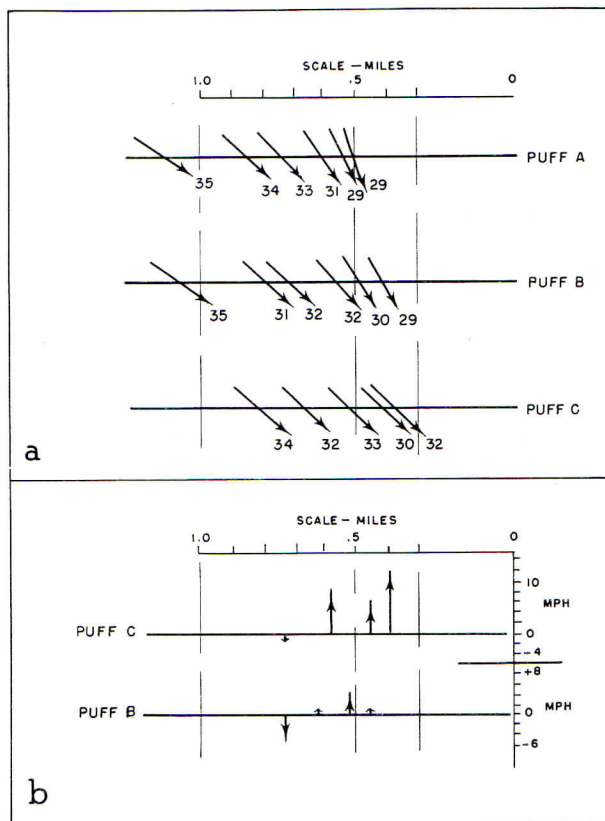

FIGURE 15.—(a) Variation of smoothed tornado relative wind vector angle with distance from center of tornado. (b) Variation of vertical speed of puff tops with distance from tornado. Puff A had very little movement and was not plotted.

at the station was influenced mainly by the prevailing pressure gradient and the outflow from the thunderstorm accompanying the heavy shower. Therefore, it is further concluded that the tornado circulation did not extend to 0.86 mile radius by the time it passed the Weather Bureau station at 1656.5 cst.

Another indication of the shrinkage of the tornado system circulation was the observation of the mutually divergent tips of the tornado and tornadic cloud at 1657 cst, when the tornado was just west of the Weather Bureau station. At this time the vortices were a little over 2 miles apart and, had the circulation around the tornado been convergent out to 2.7 miles as it was earlier, it seems as though the tip of the tornadic bulge would have pointed toward the tornado. Figures 17a and 17b, composite drawings, are plan and

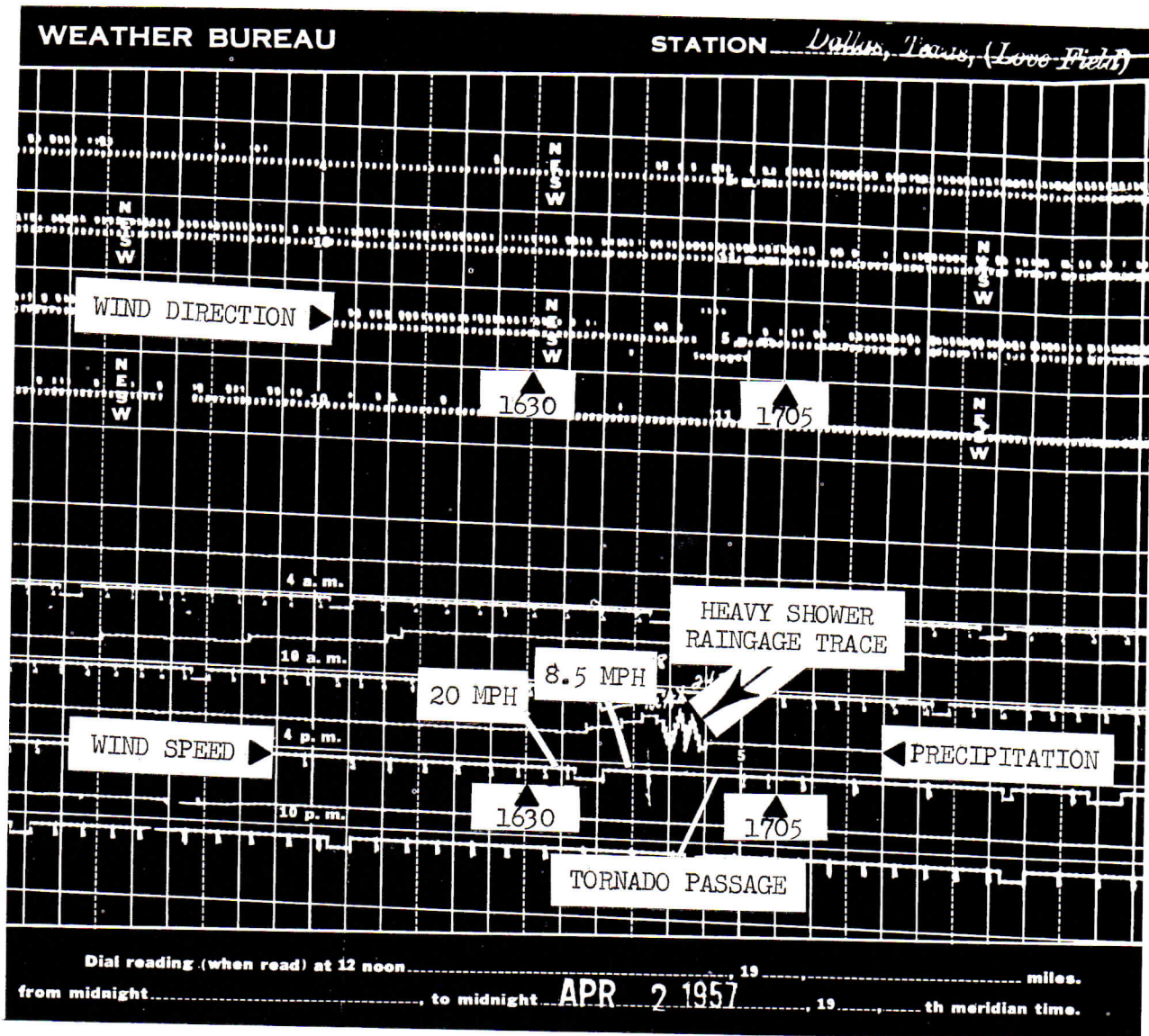

FIGURE 16.—A portion of the Dallas, Tex., autographic wind speed and direction, and precipitation record covering the time of the April 2, 1957, tornado. Attention is directed to the reduction of wind speed and the shift of wind direction during the passage of the heavy shower. A gust of 55 miles per hour (presumably from a southerly direction) occurred at 1647 CST, which was 4 minutes before the onset of the heavy shower and at a time when the tornado was 4.2 miles south of the station.

elevation views, respectively, of the diverging tornado tips at this time. Most likely, low-level diverging air having a source in the thunderstorm just to the north forced the tips away from each other. The preceding rain shower is shown in the region between the two vortices in the elevation view (fig. 17b).

That it was possible for the associated thunder-

storm system to dominate the wind field in its vicinity is indicated by the fact that rain was falling at the rate of 3 inches per hour, and that 4 minutes before the onset of heavy precipitation at the Dallas Weather Bureau station a gust of 55 miles per hour, presumably from the south, was noted on the gustmeter. A thunderstorm of sufficient activity to deliver such a high rate of

Pict)

TION

...iles.
...ime.
...vering the
...d direction
...a) occurred
...s 4.2 miles

...ld in its
...rain was
...and that
...ipitation
...gust of
...e south,
...storm of
...a rate of

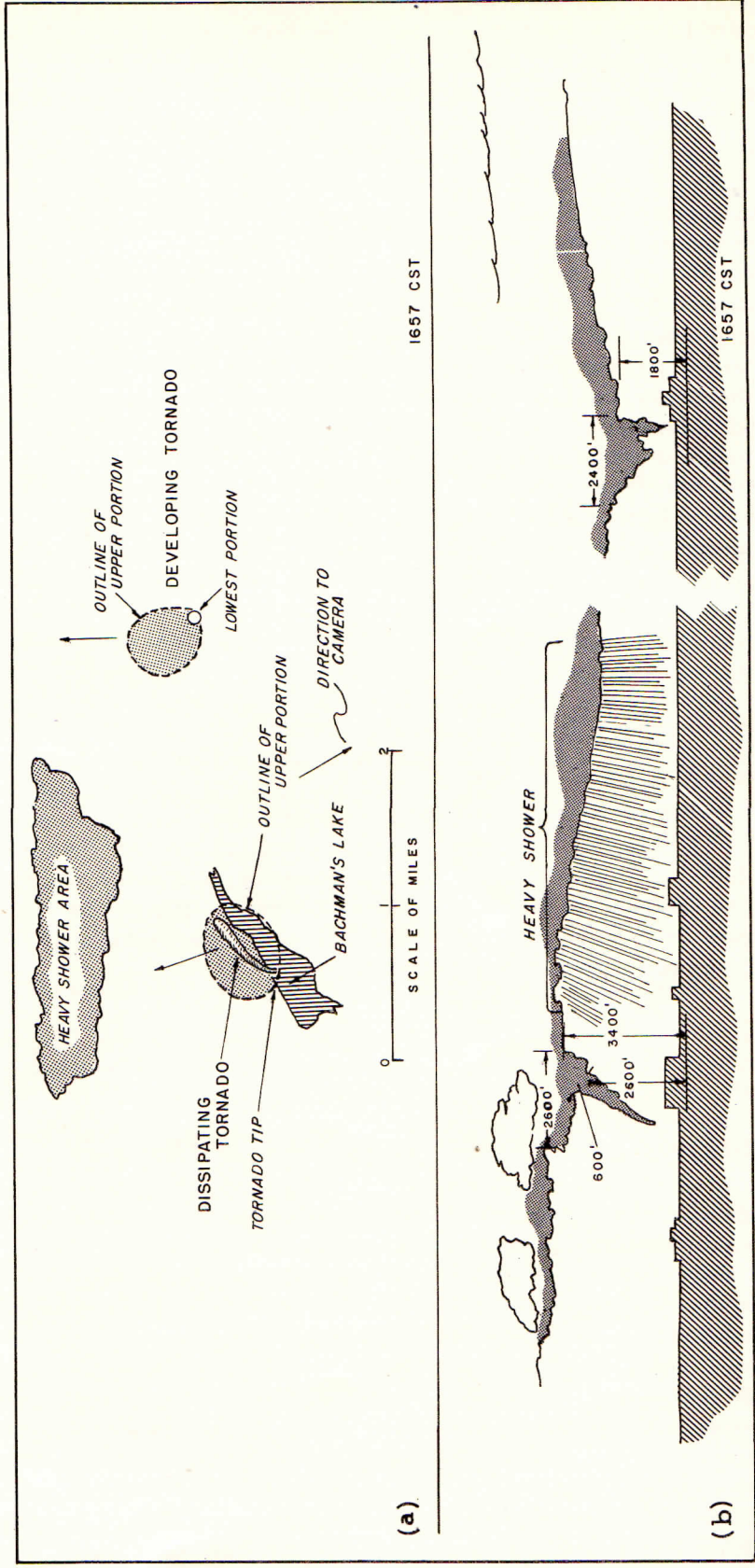

FIGURE 17.—(a) Plan view of active and developing tornadoes showing divergence of tips away from each other. The estimated location of the heavy shower is shown also. (b) Panorama drawing of the two tornadoes and the shower area as seen from a tall building in downtown Dallas. The break in the drawing indicates horizontal scaling difficulty due to nonsimultaneity of photographs.

precipitation certainly would have had the ability to produce severe downdrafts whose divergence at the ground would result in fairly strong winds. Recall that the thunderstorm was moving northward ahead of the tornado.

If the distribution of airflow all the way around the tornado, in the time interval between sketches 22 and 30, was comparable to that in the region between northwest and southwest of the tornado, some amount of updraft must have existed in the region affected by the tornado to take care of the converging mass of air. In order to test for any such updraft the vertical movements of the tops of the smoke puffs were inspected. The top of puff A had negligible vertical movement. Puff B had an average downward speed between sketches 23 and 24 (average distance from tornado center, 0.75 mi.) of 5 miles per hour, then it averaged an upward speed of 4.5 miles per hour between sketches 25 and 26 (average distance from tornado center, 0.52 mile). Its upward speed was reduced to 0.8 miles per hour between sketches 26 and 27 (average distance from center, 0.46 mile). Puff B, therefore showed a tendency for an up-and-down motion. Puff C also had a downward speed of 1.2 miles per hour in the interval between sketches 23 and 24 (average distance, 0.73 mile), somewhat less in magnitude than for puff B. It then reversed to upward speed going to a maximum of 8.7 miles per hour between sketches 24 and 25 (average distance, 0.58 mile). The upward speed dropped

to 6.3 miles per hour between the next two sketches (average distance, 0.47 mile), then increased again to 12 miles per hour between sketches 26 and 27 (average distance, 0.38 miles). If it continued to accelerate upward at approximately the same rate, its speed at the time of sketch 27 would have been as high as 15 miles per hour.

Figure 15b shows the vertical speed vectors for puffs B and C. It shows that upward speed occurred inward from about 0.7 mile for puffs B and C. As mentioned earlier, puff A showed no definite vertical movement in the region between 0.7 and 0.5 mile from the tornado center (it was 0.5 mile from the tornado center when the picture series ended). The results for puffs B and C would appear to bear out the idea that the convergent vectors shown in figure 15 would require some vertical movement of the air. However, the results for puff A appear contradictory. Either nonsymmetrical air flow in the tornado or errors in measurements could explain the contradiction.

Any question of the effect of positive buoyancy in the puffs that might have existed as the result of temperature excess over environment contained in the smoke at the time of exit from the stack seems to be answered by the fact that puff A, the last one to come from the stack, had very little tendency to move upward. In addition, the lower level effluent between puff A and the stack showed little buoyancy. Hence, for the time interval here, the puffs were treated as if they had neutral buoyancy.

8. ROTATIONAL CHARACTERISTICS OF THE OUTER REGION

An item of considerable controversy concerning tornadoes is whether or not their flow is irrotational as is the case of the mathematical model vortex. It was thought that use of the smoke-puff measurements to test for this characteristic might be of interest even though the measurements were outside of the region commonly thought of as the tornado. Accordingly tangential components of the vector winds derived earlier were used to test the flow, insofar as it was determined, for this rotational characteristic.

In the irrotational model vortex the products

of all radii and their associated tangential velocities ($V_t \times R$) are constant, that is, as the radius decreases the tangential component of the velocity increases in the inverse proportion. This condition exists to a certain minimum radius inside of which solid rotation is assumed to occur.

To test for the rotational character of the airflow in the Dallas tornado, the tangential component of each velocity vector was multiplied by the radius at which it was determined. The product for each puff, that is for ($V_t \times R$), was plotted on a graph of ($V_t \times R$) versus R , where

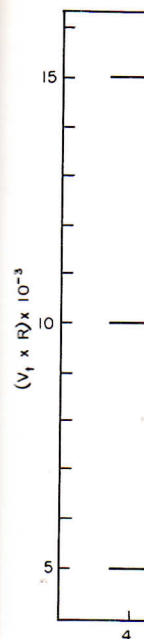

FIGURE 18.—
radius for t
of curves
Dallas torn

R is the r
18, where

By use of
tornado win
tween 1.1 a
and between
was investig
ing the tim

In the ca
nonconverg
of the radi
the radius

According
Dallas torn
puted and p
 R . The res
Also shown
is constant.
cut sharply
($R \times U$) = co

next two
then in-
between
38 miles).
approximate
time of
15 miles

ectors for
speed oc-
r puffs B
showed no
n between
er (it was
the picture
B and C
t the con-
ld require
wever, the
7. Either
or errors
radication.
buoyancy
the result
contained
the stack
uff A, the
very little
the lower
ck showed
e interval
ad neutral

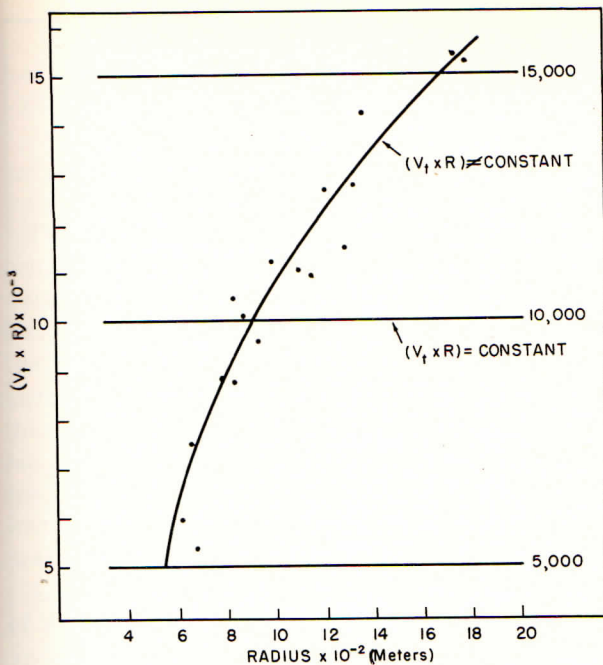

FIGURE 18.—Variation of the $(V_t \times R)$ products with radius for the Dallas tornado. Shown also are families of curves where $(V_t \times R)$ is constant. Disposition of Dallas tornado curve indicates rotational flow.

R is the radius. The result is shown in figure 18, where the variation of the Dallas tornado

$(V_t \times R)$ -products with radius R is plotted on a background of a family of curves of $(V_t \times R) = \text{constant}$. The curve for the Dallas tornado was hand-smoothed for all the available points. Since the $(V_t \times R)$ -products decrease with decreasing radius, the rate of increase of V_t with decrease of radius R , is less than that required for irrotational flow. Hence, the vortex flow was rotational in a cyclonic sense between 600 and 1,800 meters (about 0.3 to 1.10 miles) from its center.

Since the vortex was rotational, it is possible that the vertically aligned cloud tags, that were shown in the descriptive section to exist so persistently near this tornado, were actually small peripheral vortices that had the same rotational sense as the tornado (i.e., cyclonic), and which also moved around the tornado in its gross circulation. An outstanding example of one of these possible incipient vortices is shown in sketches 27 and 28. It is hypothesized that some impulsive addition of momentum on one side of the tornado could provide sufficient additional rotation (via shear) to allow the incipient minor vortices to exist for a short period. The assumption was used that the tangential flow was symmetrical around the tornado although only the western portion was measured.

9. CONVERGENCE IN THE NEAR VICINITY OF THE DALLAS TORNADO

By use of the radial components of the derived tornado winds determined earlier, the region between 1.1 and 0.3 miles from the tornado center, and between 600 and 1,300 feet above the ground, was investigated for horizontal convergence during the time between sketches 22 and 30.

In the case of the vortex with the central sink, nonconvergence would require that the product of the radial component (U) of the velocity and the radius (R) be constant.

Accordingly, to test for convergence of the Dallas tornado, the $(R \times U)$ -products were computed and plotted on a graph of $(R \times U)$ versus R . The resulting curves are shown in figure 19. Also shown are families of curves where $(R \times U)$ is constant. The $(R \times U)$ curves for each puff cut sharply across the families of curves of $(R \times U) = \text{constant}$, indicating that as R de-

creased, so did $(R \times U)$. In other words, U did not increase sufficiently with decreasing radius to keep $(R \times U)$ constant. In this case U actually decreased as R decreased. Hence, the conclusion is that the tornado was convergent for the time and place measured. Separate curves were plotted for these puffs since there was some divergence of these curves closer to the center of the tornado.

An example of the differences between the time rate of change of volume for several radii is shown in table 2. Here a slice 1 meter thick was assumed.

From this table it can be seen that convergence was increasing with decreasing radius. Under the assumption that the air in the 1-meter-high slice averaged 1 kilogram per cubic meter, there was an excess of 33 metric tons of air per second accumulating between 1,800 and 1,500 meters

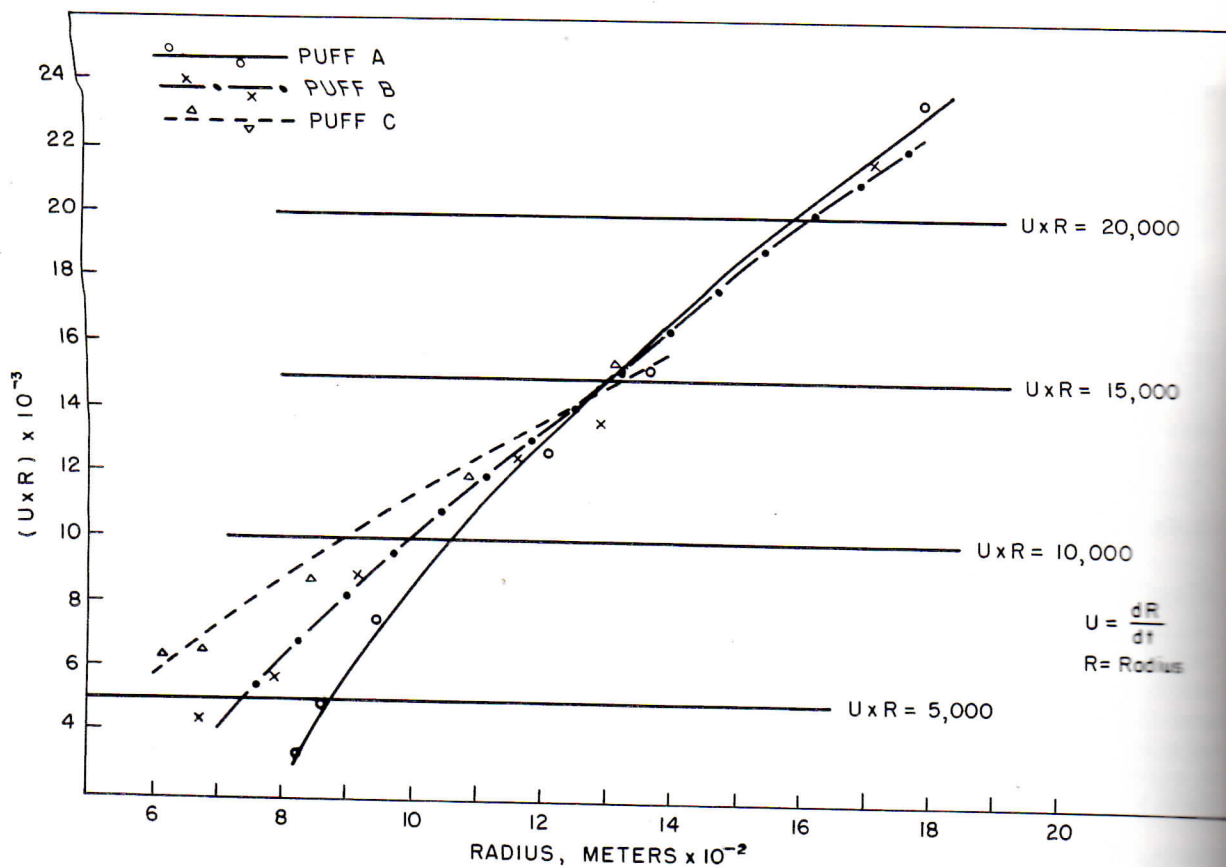

FIGURE 19.—Variations of radial component wind times radius ($U \times R$) with R , for the tornado-wind. Families of curves with $(U \times R) = \text{constant}$, denoting nonconvergence, also are shown. The curves for the Dallas tornado indicate convergence for the region investigated.

radius, 37 excess tons per second between 1,500 and 1,160 meters, etc. As far as the author knows, no similar computations have been made earlier, so there are no data with which to compare these results.

In connection with all the measurements derived from the smoke puff movements, it is to be remembered that they should be considered in a qualitative sense. Although considerable care was used in making the computations, the assumption of a constant direction for the smoke puffs and some graphical computations as well as other items could have resulted in errors.

TABLE 2.—Time rate of change of volume

R (meters)	dV/dt ($m.^3 \text{ sec.}^{-1}$)	Time rate ($m.^3 \text{ sec.}^{-1}$)
1,800.....	147×10^3	2000
1,500.....	114×10^3	1500
1,160.....	77×10^3	1000
800.....	39×10^3	500

Tornado principles were used history of 1937. Fifth numerical system the tornado with photog speed of the was estimate least findin 1. The top of a dark c case of the ventual air 2. Movies reation was 3. The top 1200 feet to re-demise (4. The fun long undefi for (sketch parent cloud from about nearly 2,300 5. Large o tornado and time periods for example greatest char 6. Photog upward even of the grou and 22). 7. More de up when th ground (see with and cor see sketch 8. Configu air's cloud movement of as far outwa sketches 29 a 8. The lar

10. CONCLUDING REMARKS

Tornado photographs, scaled by means of the principles of photogrammetry and perspective, were used to synthesize a detailed size and shape history of the Dallas, Tex., tornado of April 2, 1957. Fifty-one photographs were used in the historical synthesis. By locating the position of the tornado on a map of the damage path for each photograph used and utilizing the average speed of the tornado, the time of each photograph was estimated to tenths of a minute. The significant findings are summarized below.

1. The tornado dropped down from the base of a dark cloud. The ragged and torn appearance of the cloud base indicated considerable differential air motion in that region (see sketch 1.)

2. Movies of the tornado confirmed that its rotation was cyclonic.

3. The tornado height increased from an initial 1,100 feet to a height of 3,800 feet at the time of its demise (sketches 1 and 51).

4. The funnel width at the ground varied from being undefined there (tip off the ground) to 120 feet (sketch 37), and the width at the base of the parent cloud, when it could be measured, varied from about 400 feet in diameter (sketch 2) to nearly 2,300 feet (sketch 34).

5. Large changes in the size and shape of the tornado and its debris cloud took place in short time periods (sketches 10-13, 15-16, and 26-27, for example) with the debris cloud showing the greatest change for a given period.

6. Photographs showed debris being carried upward even though the condensation funnel was off the ground as much as 750 feet (sketches 19 and 42).

7. More debris and dust appeared to be stirred up when the trunk was suspended above the ground (see sketch 42) than when the trunk was wide and continuously in contact with the earth (see sketch 37).

8. Configuration of the ground-based dust or debris cloud suggests that there was rather rapid movement of air upward along the tornado trunk as far outward as 500 feet from the center (see sketches 29 and 39, for example).

9. The large overhang characteristic of the de-

bris cloud indicated further that *large vertical shear existed near the trunk with higher speed vertical air flow nearer the center* (sketches 27, 28, 39, 41, and 42).

10. The extreme narrowness of that portion of the debris cloud nearest the ground further indicated that *there was a strong inward radial component near the ground* at least part of the time (sketches 12, 15, 20, 40-42, and 46).

11. The average translational speed of the tornado was determined to be a little under 27 miles per hour by the known times that the powerlines were severed.

12. Vertically aligned peripheral clouds about 1,000 feet from the tornado center and near the cloud base bent inward in their lower portions, suggesting an *inward component of flow between 1,000 and 1,400 feet from the ground* (see sketches 29 and 31).

13. Toward the end of its lifetime the tornado became extremely elongated and approximately the middle one-third of the thin funnel was lying nearly in a horizontal attitude. Its horizontal projection was nearly 0.6 mile in length at this time (sketch 49).

14. At the time of the elongated form the funnel was *traveling in a direction about 45° from a horizontal projection of its longitudinal axis* (see fig. 1, north section).

15. The shape of the tornado-cloud varied from the concave-cone type (sketches 24-28), to the classical elephant-trunk shape (sketches 34-38), to the thin ropelike type (sketch 49). The trunk sometimes assumed a shallow "S"-shape (sketches 3, 5, 25, 49) during which times part of the core was nearly horizontal.

16. A cloud bulge that developed into a tornado was discovered 1 mile east of the active tornado near the midpoint of the tornado lifetime (fig. 3).

17. After the cloud bulge became quite bulky, very narrow vortices extended intermittently to the ground while it was over the north section of Dallas. The movies showed dust being carried upward but no damage was reported. The tornado later caused damage to farm structures north of Dallas.

18. The paths of the active and inactive tornadoes were slightly divergent with time (fig. 1).

19. The active tornado extended downward from a cloud that appeared to be not cumuliform but rather more like vertically stacked layers of stratus clouds whose top very early in the tornado lifetime was computed to be at about 11,000 feet. No data were available on the height at any later time (fig. 6).

20. The bottom cloud layer or shelf was computed to be 1.5 by 2.7 miles across early in the tornado lifetime and increased to 3.2 by 4.0 miles in extent in the last fifth of the tornado lifetime (fig. 4).

21. As the active tornado was weakening and the tornadic bulge was growing larger and starting to send vortices to the ground, the photographs showed that the darkest areas beneath the cloud system associated with the two vortices were shifting with time to the area of the tornadic cloud.

22. While the tornado and the tornadic cloud bulge were in existence at the same time their tips were mutually divergent, that is, the tip of the tornado lay to the southwest while that of the bulge lay to the southeast. It is suggested that divergence of air between them caused the observed effect (fig. 17).

23. The tornado height and average width varied together in such a manner that at times these variations were in phase and at other times out of phase. Correlation coefficients for these different phases were generally quite high (fig. 9).

24. The tip rose and lowered rapidly at times and at other times remained at almost the same altitude; the tip contacted the ground only a little over 12 percent of the time or for a total of 4.2 minutes (fig. 9).

25. There was a tendency for the tip to go to and remain on the ground when the height and width were both increasing, and for it to rise when one or both were decreasing. When width and height were steady the tip remained at about the same height above the ground (fig. 9).

26. The tip at one time showed a segmented structure and in several instances revealed indications of a double-sleeved structure; at one time

a definite hollow structure was revealed. The ratio of diameters of outer to inner sleeve was 2.7 to 1 when the tornado was at location-mile 11.5.

27. Elements of a smoke plume involved in the tornado circulation were used to show that the tornado system influenced the flow of air in its vicinity an estimated 2.7 miles from the center when the tornado was near the midregion of its path. Later, near the end of the path, an area less than 0.8 mile in radius was affected (fig. 12).

28. Tornado wind movement derived from the movement of the smoke plumes between 0.3 and 1.1 miles from the tornado center was found to be cyclonic and sharply inward toward the center at about the time of the tornado's midlife (fig. 14).

29. Smoothed tornado-wind vectors (smoke-puff derived) showed that the cross-radial angle of flow increased with decreasing radius (fig. 15a).

30. The smoke plume elements that entered the tornado circulation were used to show that there was upward movement of air that tended to increase in upward speed with decreasing distance from the tornado. No measurements were possible closer than 0.3 mile from the center (fig. 15b).

31. The distribution of the tangential wind components with radius, determined by the smoke-puff movements, revealed that the flow was rotational in a cyclonic sense between 0.3 and 1.1 miles from the center (fig. 18).

32. The variations of the radial components with radius of these derived wind speeds showed that the flow was convergent with excess mass diverging upward out of a given unit layer, again between 0.3 and 1.1 miles radius and between 500 and 1,300 feet above the ground (fig. 19).

33. The evidence for cyclonic rotational flow in the tornado between 0.3 and 1.1 miles from the center leads to the tentative conclusion that the vertically aligned cloud tags, such as in sketches 13 and 14, and 27 through 29, in the vicinity of 0.2 mile from the center were actually incipient vortices having cyclonic rotation while at the same time rotating as a unit cyclonically around the tornado in the gross tornado circulation.

The author's appreciation to I. J. ...
ful criticism ...
aration of ...
for his inte ...

1. Handbook of Tornadoes, Photographic Report, Agricultural Station, ...
2. "Principles of Tornadoes," American Meteorological Society, ...
3. Stuart G. ... 1957," Technical Report, Agricultural Station, ...
4. E. P. Segler, "Velocity of Tornadoes," Report, Agricultural Station, ...
5. Walter H. ... the Two ...

vealed. The
r sleeve was
location-mile

olved in the
ow that the
of air in its
n the center
region of its
ath, an area
ted (fig. 12).
red from the
ween 0.3 and
s found to be
the center at
fe (fig. 14).
ors (smoke-
radial angle
radius (fig.

t entered the
w that there
ended to in-
ing distance
ts were pos-
center (fig.

rential wind
ed by the
the flow was
n 0.3 and 1.1

components
eeds showed
excess mass
layer, again
between 500
. 19).

ional flow in
les from the
ion that the
s in sketches
e vicinity of
lly incipient
hile at the
cally around
ulation.

ACKNOWLEDGMENTS

The author wishes to express his sincere appreciation to Dr. Morris Tepper for providing helpful criticism and encouragement during the preparation of this material and to William A. Hass for his interest in this work. No small credit is

due the dozens of public spirited citizens of Dallas who contributed hundreds of photographs and hundreds of feet of movie film of this tornado, without which this study could never have been undertaken.

REFERENCES

1. *Handbook of Photogrammetry*, American Society of Photogrammetry, 1952.
2. "Principles of Linear Perspective," *Encyclopaedia Americana*, 1953 edition, vol. 21, pp. 632-640.
3. Stuart G. Bigler, "The Dallas Tornado of 2 April 1957," Tornado Damage Surveys, Raw Data Report, *Scientific Report No. 2*, on Contract Cwb-9116, Department of Oceanography and Meteorology, Agricultural and Mechanical College of Texas, College Station, Tex., 1957.
4. E. P. Segner, Jr., "Calculations of Minimum Wind Velocity Causing Structural Damage in the Dallas Tornado," Tornado Damage Surveys, Raw Data Report, *Scientific Report No. 2*, on Contract Cwb-9116, Department of Oceanography and Meteorology, Agricultural and Mechanical College of Texas, College Station, Tex., 1957.
5. Walter H. Hoecker, Jr., "History and Measurement of the Two Major Scottsbluff Tornadoes of June 27, 1955," *Bulletin of the American Meteorological Society*, vol. 40, No. 3, March 1959, pp. 117-133.
6. U.S. Weather Bureau, *Meteorology and Atomic Energy*, Washington, D.C. July 1955, 163 pp. (see p. 59).
7. Paul C. Kangieser, "A Physical Explanation of the Hollow Structure of Waterspout Tubes," *Monthly Weather Review*, vol. 82, No. 6, June 1954, pp. 147-152.
8. Carl M. Reber, "The South Platte Valley Tornadoes of June 7, 1953," *Bulletin of the American Meteorological Society*, vol. 35, no. 5, May 1954, pp. 191-197.
9. Walter H. Hoecker, Jr., "Comparison of Dimensional and Time-Trend Characteristics of Some Tornadoes and Waterspouts between 1896 and 1957," Presented before National Meeting, American Meteorological Society, Washington, D.C., May 1958.

THE SYNOPTIC SITUATION

JEAN T. LEE

District Meteorological Office, Kansas City, Mo.

[Manuscript received October 16, 1958]

ABSTRACT

A synoptic picture of the weather situation at the surface and aloft on April 2, 1957, is presented. Maximum instability occurred along a low-level moisture axis, with a low-level jet in close proximity. The upper-level jet indicates an area of divergence over the tornado activity area which covered portions of Oklahoma, the Texas Panhandle, and north-central Texas.

1. INTRODUCTION

The Dallas, Tex., tornado of April 2, 1957, was only 1 of more than 20 tornadoes that occurred on this date over portions of Oklahoma, the Texas Panhandle, and north-central Texas (fig. 1). The Dallas tornado was unique mainly in the number of photographs and movies that were taken during its life cycle.

The first reported severe activity during the day was a tornado north of Nocona, Tex.—80 miles north-northwest of Fort Worth, Tex.—about 1530 cstr, followed by a second report from the vicinity of Ringling, Okla., 100 miles north-northwest of Fort Worth. Reports were received prior to this of building thunderstorms to the west of Fort Worth. The Dallas tornado occurred at 1630 cstr. Severe thunderstorms and tornadoes continued throughout the late afternoon and extended past midnight mainly in the Oklahoma area.

The formation of the Dallas tornado cannot be ascribed to any definite initiating causes at the present time. The synoptic picture was very

complicated with some very dramatic changes occurring with a slowly moving cold front in west Texas.

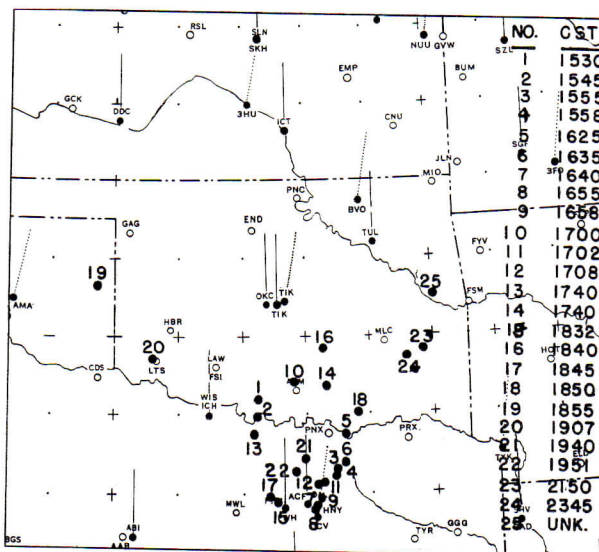

FIGURE 1.—Location and time (cstr) of tornadoes in Texas and Oklahoma, April 2, 1957.

During the
ulation pat
short waves
of the Gulf
southeast di
vigorous, pe
the United S
lations that

Associated
of a number
tems in the
of these Low
toward the C

On March
waves broug
1,006-milliba
western Kan
This storm
pressure of 1
in eastern A
speed of 18
tensity, this
knots into so
and into cer
April 2 (fig.
through Tex
next day th
Pennsylvani
and thence v
started north
area.

Farther to
moved in fro
2 (figs. 5 and
line from we
southern Col
ern Mexico.
creased in sp
knots and de
for the next

Figures 6
charts. The
outbreak we
ating the are
ity than in o
States there
present on t
39). The fir

2. SPECIAL FEATURES

During the preceding weeks the upper-air circulation pattern was dominated by a series of short waves in the westerlies which moved out of the Gulf of Alaska in a south-southeast to southeast direction. These short waves were very vigorous, penetrating to the southern border of the United States and forming closed low circulations that then migrated northeastward.

Associated with this regime was the formation of a number of vigorous surface low pressure systems in the southwestern Plains area. The path of these Lows took them on a northeastward course toward the Ohio River Valley.

On March 31 (fig. 2), one of these strong short waves brought about the formation of a weak 1,006-millibar closed surface circulation in southwestern Kansas and the Oklahoma Panhandle. This storm deepened on April 1 (fig. 3) to a pressure of less than 1,000 millibars with a center in eastern Arkansas having an average 24-hour speed of 18 knots. After reaching maximum intensity, this storm moved northeastward at 30 knots into southern Indiana by 1830 csr (fig. 4) and into central Pennsylvania by 0630 csr on April 2 (fig. 5). The associated cold front swept through Texas on the 1st and by 0630 csr the next day the cold front extended from central Pennsylvania southward into southern Georgia and thence westward into central Texas, having started northward as a warm front in the latter area.

Farther to the west a new surge of cold air had moved in from the Pacific and at 0630 csr April 2 (figs. 5 and 6) the leading edge was found in a line from western Wyoming through western and southern Colorado and western Texas into northern Mexico. Its eastward movement had decreased in speed from 30 knots to less than 20 knots and decreased further to less than 15 knots for the next 24 hours.

Figures 6 through 10 are sectional surface charts. The surface parameters in this tornado outbreak were probably more useful in delineating the area of possible maximum severe activity than in other cases. Over the South-Central States there were two low-level warm tongues present on the morning of April 2 (figs. 6 and 39). The first was in eastern Texas and Louisi-

ana and the second was in the eastern portion of West Texas preceding the cold front. The western intrusion had the highest surface temperature during the afternoon with readings above 90° F. The eastern warm tongue at 1530 csr had temperatures only in the eighties, while between the two tongues there remained an area with readings in the seventies.

The cold front on the morning of April 1 had reduced the dew point temperatures over Texas to at least the lower fifties, except in the immediate vicinity of the Gulf coast. However, by 1830 csr that afternoon one weak influx of moisture began moving northward in extreme southern Texas with a second increase starting from the vicinity of Galveston, Tex., toward Fort Worth, Tex. Dew points in the seventies still remained off the coast. During the night, the western thrust of moisture moved into the Del Rio, Tex., area while the eastern one started to move into southern Oklahoma. After 0630 csr April 2, a rapid change began with the western intrusion retracting eastward as the other one built northward. By noon 60° dew points had penetrated as far north as Oklahoma City. From noon to 1530 csr the 70° dew points pushed rapidly out of the Gulf from just west of Galveston, Tex., to the vicinity of Fort Worth-Dallas. This rapid influx of moisture appeared to be one of the main factors in decreasing the stability of the air over northern Texas, and the tornado activity was centered around this eastern moist tongue.

The wind pattern at the surface for 0630 csr April 2 showed the winds over Texas to be east-southeast to southeast at 10 to 15 knots, except near 20 knots at Corpus Christi and Brownsville, Tex., and about 25 knots at Abilene, Tex. At noon these winds had a tendency to shift toward the south in the area east of the cold front and south of the wind-shift or quasi-stationary front in northern Texas. The speed of the wind had increased to about 20 knots which was held during the rest of the afternoon. The quasi-stationary front or wind-shift line from the vicinity of Dallas to Wichita Falls, Tex., remained weak with only a change in wind direction across the front from east-southeast to southeast or south-southeast.

changes occur
in west

NO.	CST
1	1530
2	1545
3	1555
4	1558
5	1625
6	1635
7	1640
8	1655
9	1658
10	1700
11	1702
12	1708
13	1740
14	1740
15	1832
16	1840
17	1845
18	1850
19	1855
20	1907
21	1940
22	1951
23	2150
24	2345
25	UNK.

does in Texas

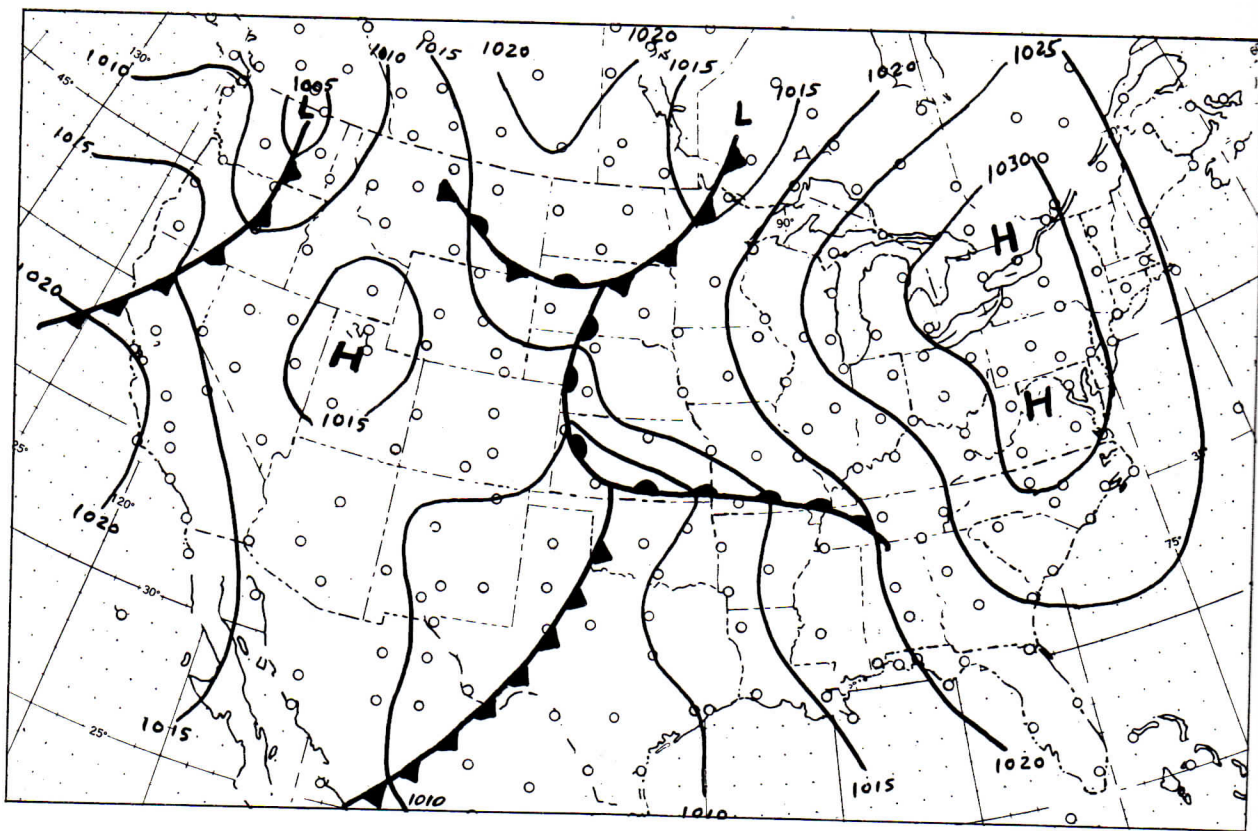

FIGURE 2.—Surface pressure map, 0630 cst, March 31, 1957.

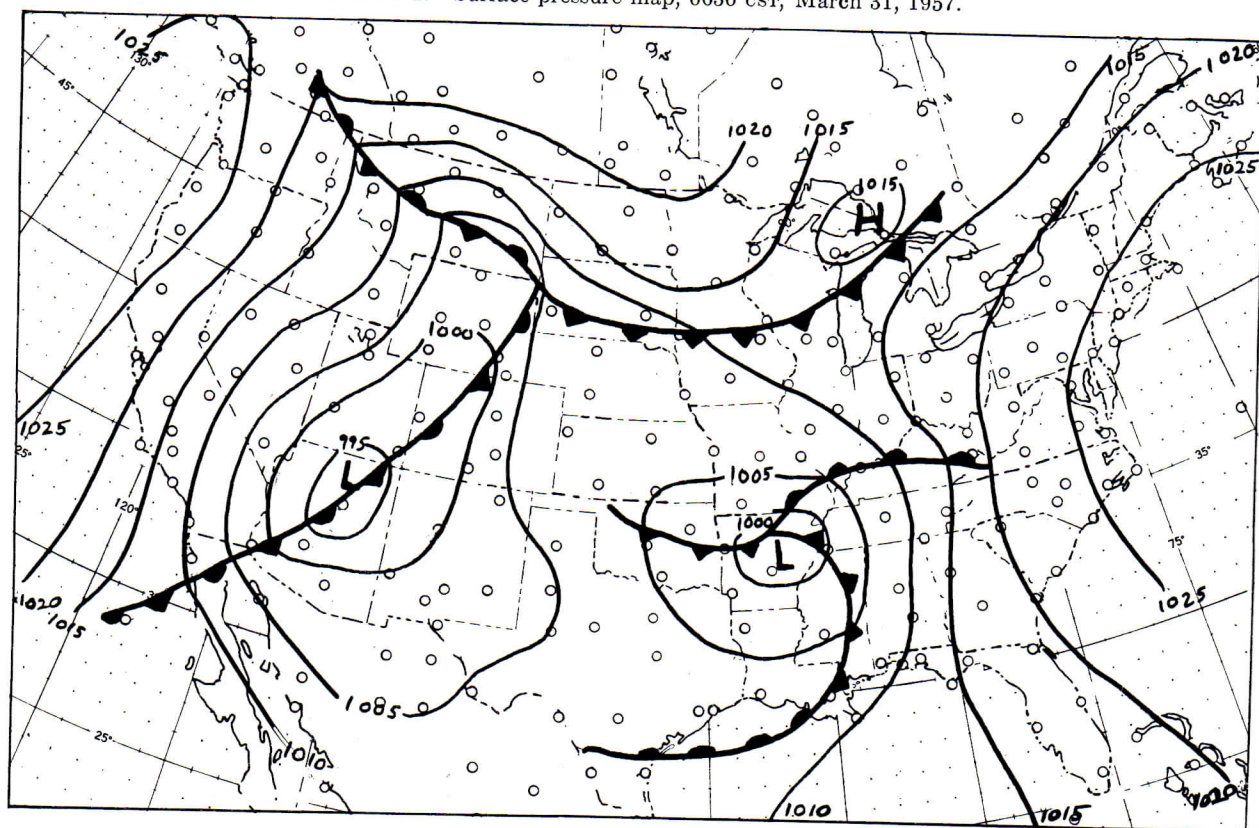

FIGURE 3.—Surface pressure map, 0630 cst, April 1, 1957.

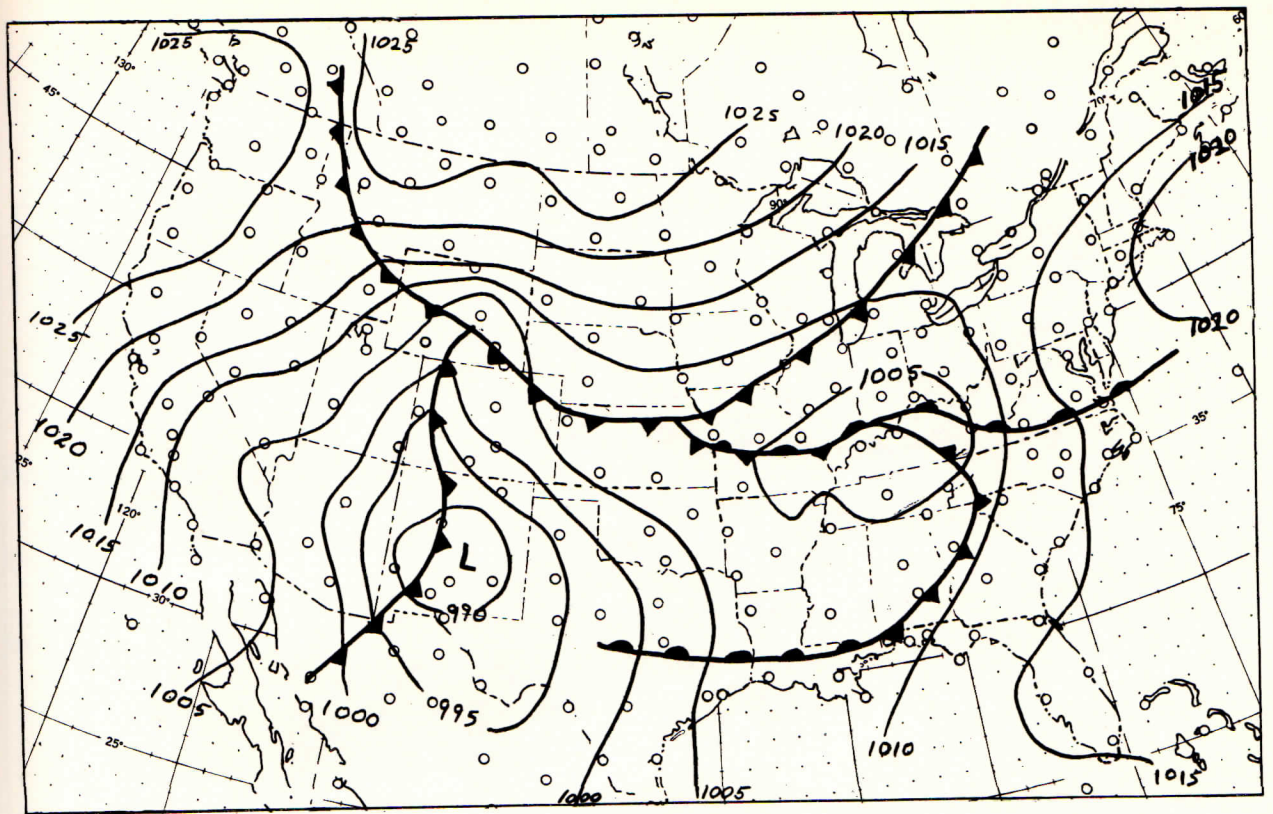

FIGURE 4.—Surface pressure map, 1830 cst, April 1, 1957.

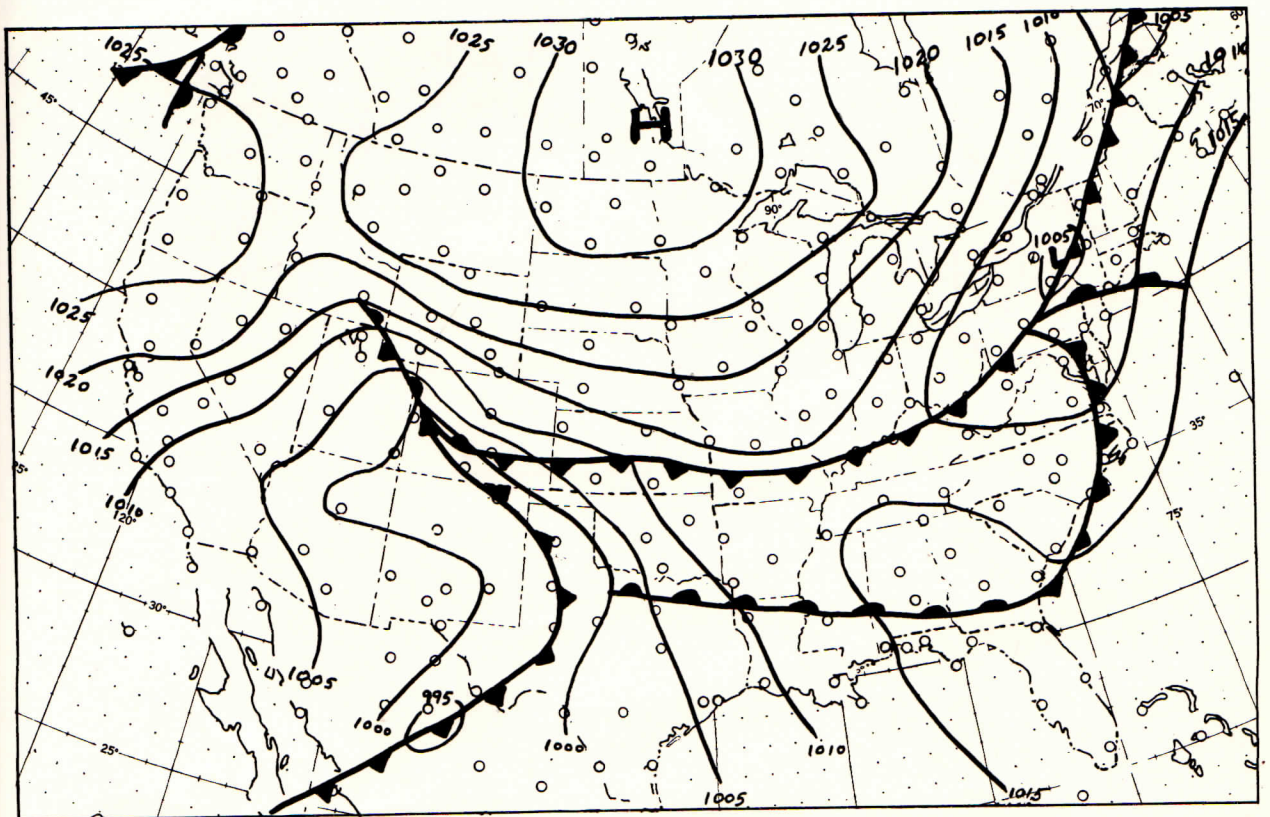

FIGURE 5.—Surface pressure map, 0630 cst, April 2, 1957.

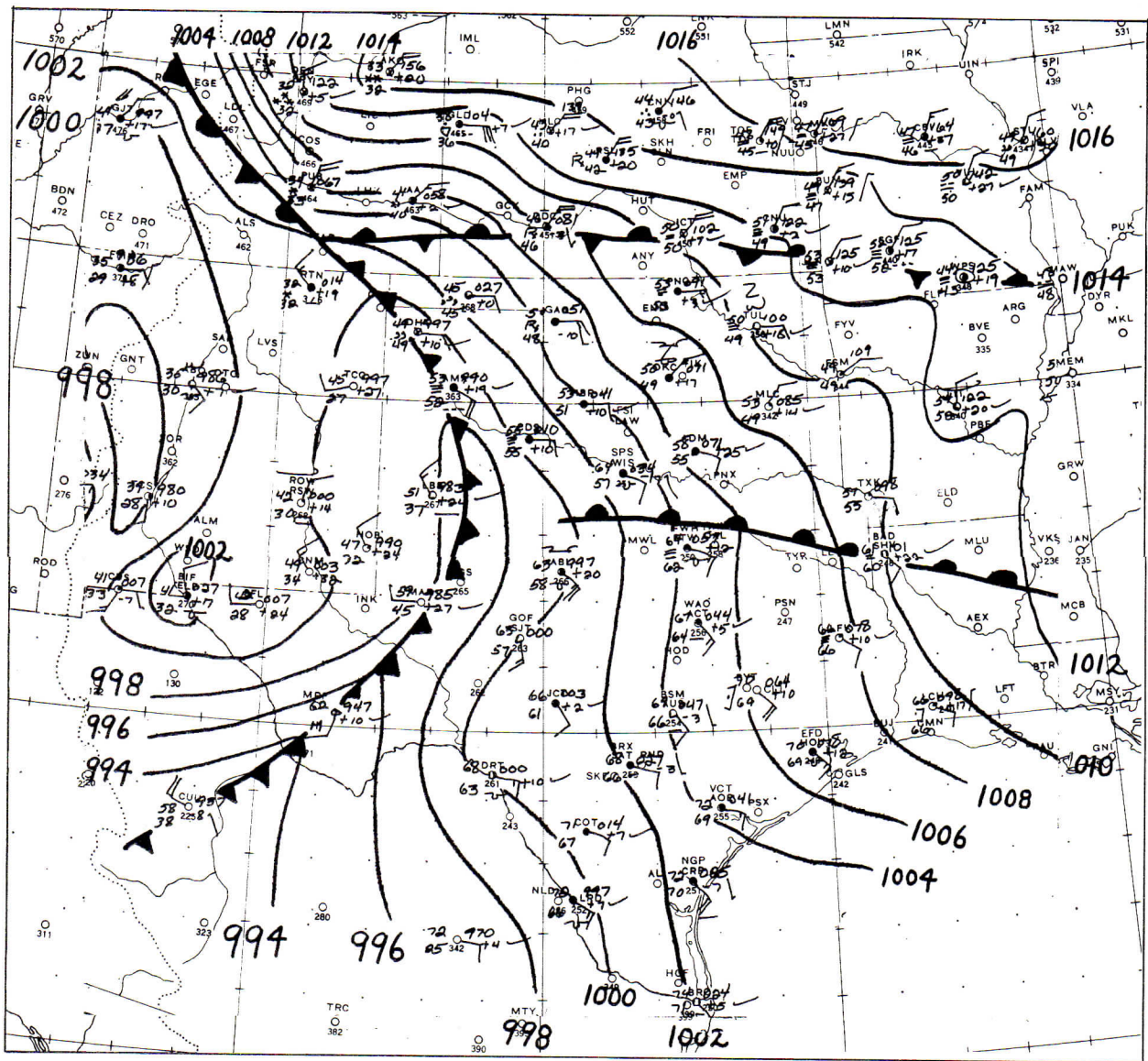

FIGURE 6.—Sectional surface chart, 0630 CST, April 2, 1957.

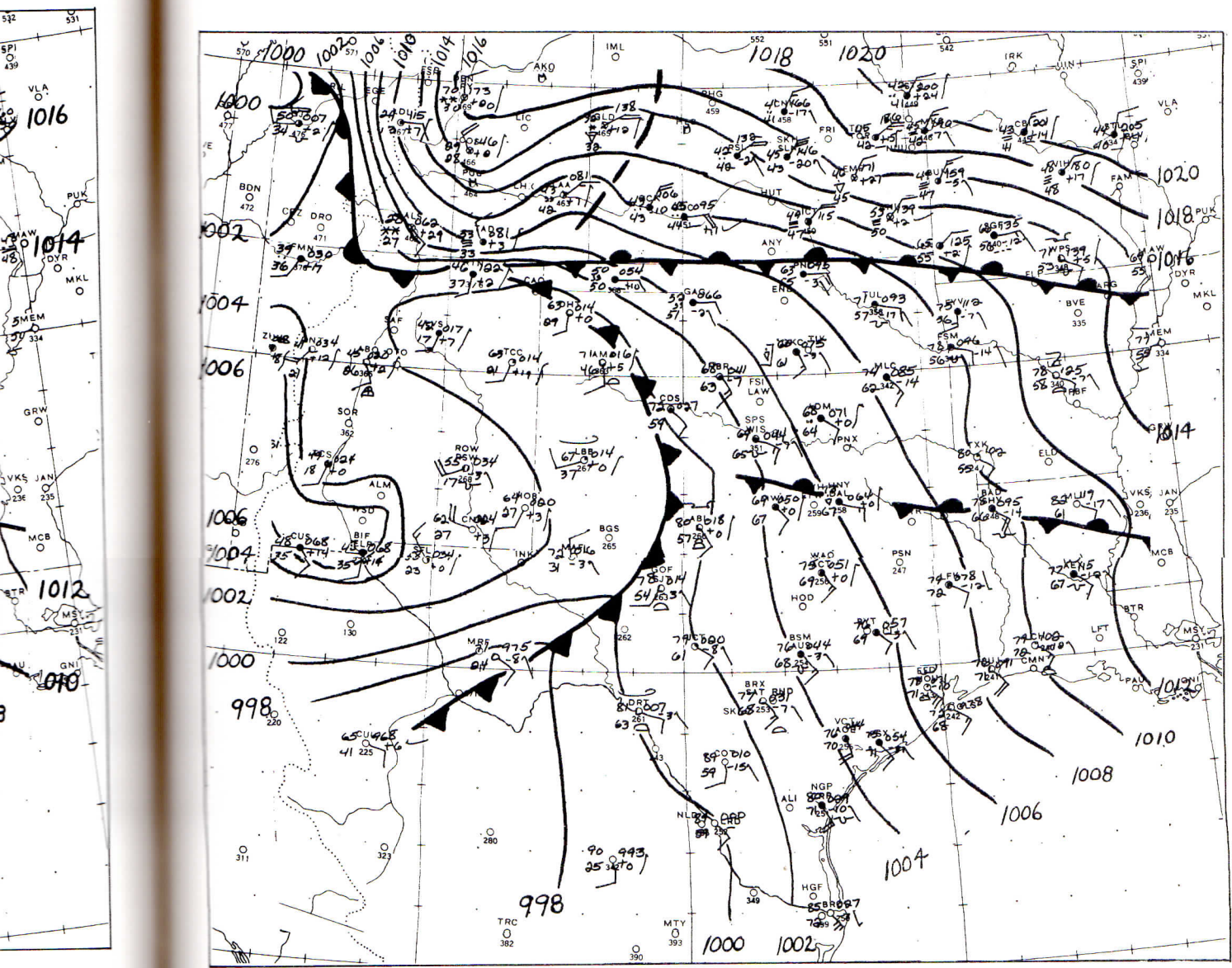

FIGURE 7.—Sectional surface chart, 1230 cst, April 2, 1957.

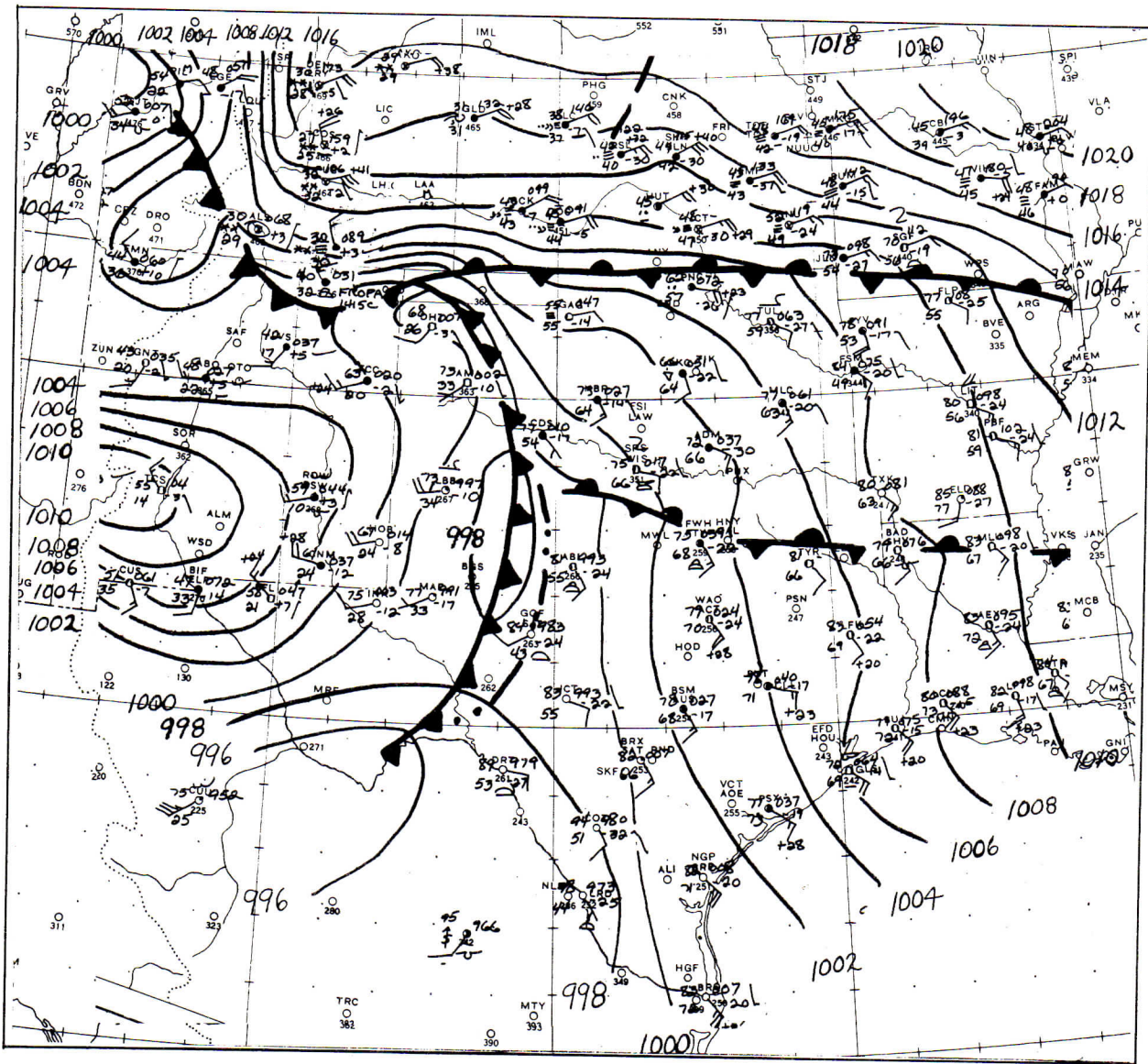

FIGURE 8.—Sectional surface chart, 1530 cst, April 2, 1957.

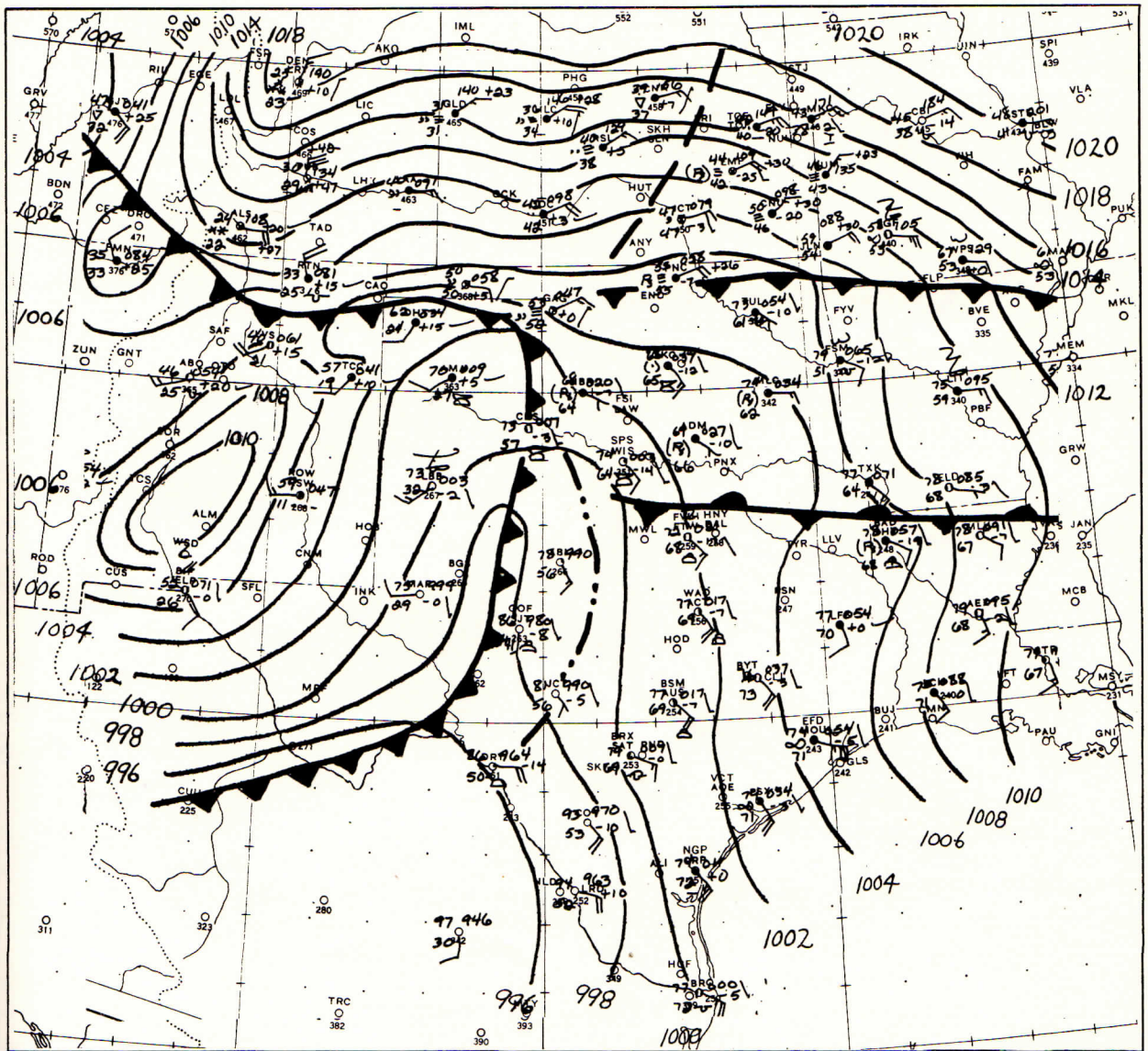

FIGURE 9.—Sectional surface chart, 1830 CST, April 2, 1957.

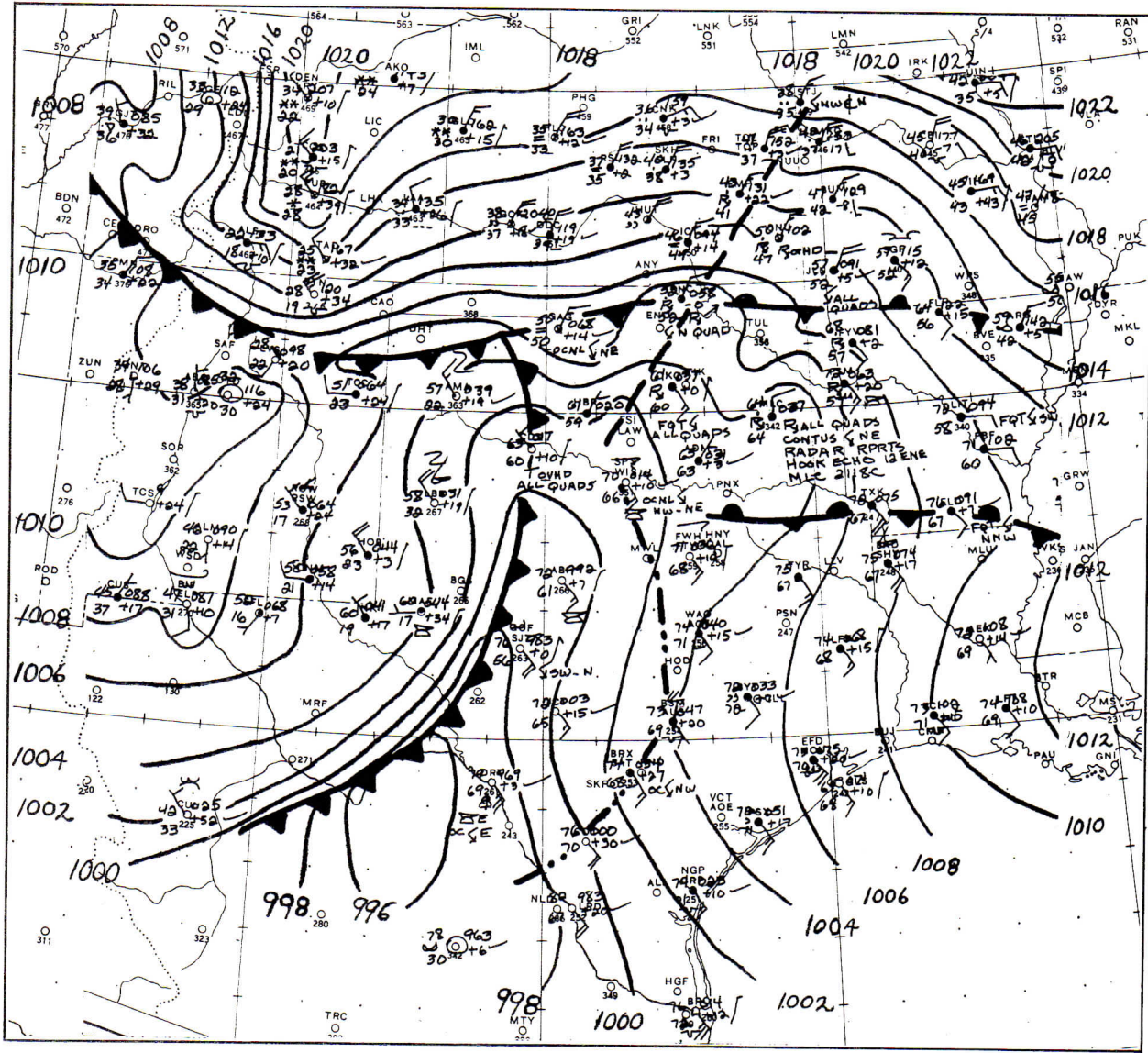

FIGURE 10.—Sectional surface chart, 2130 cst, April 2, 1957.

At 850
wind jet w
The axis o
was from
weak spee
by winds o
at Amaril
the axis ha
to just wes
at Laredo,
ther eastw
of the axis
the center
more, Okla
along the a
moved to t
tern chang
Galveston
Dallas, ind
gence.

The 850-
to that indi
tively dry
of less than
on April 1

On April
(fig. 18) ha
ture of -2
Ark. This
while a sec
down the w
19-24) car
-8° C. in
the same ti
to 4° C., wh
westerly.
April 2, the
closed Low
of Albuque
ward at 10
now found
Over Texa
creasing to
Christi, and
this time w

3. 850-MILLIBAR CHARTS

At 850 millibar (figs. 11 to 17) the low-level wind jet was more apparent than at the surface. The axis of the jet at 2100 cst April 1 (fig. 13) was from Brownsville to Amarillo, Tex., with weak speed divergence indicated along the axis by winds of 30 knots at Brownsville and 40 knots at Amarillo. By 0300 cst (fig. 14) on April 2, the axis had shifted to a line from Laredo, Tex., to just west of Altus, Okla., with 50-knot winds at Laredo, and 55-knot winds at Altus. A further eastward movement of the northern portion of the axis occurred so that at 0900 cst (fig. 15) the center was on a line from Waco, Tex., to Ardmore, Okla., with winds near 40 knots reported along the axis; at 1500 cst (fig. 16) the axis had moved to the vicinity of Dallas. This wind pattern changed by 2100 cst (fig. 17) to 50 knots at Galveston and a 45-knot wind to the east of Dallas, indicating apparent weak speed convergence.

The 850-millibar moisture pattern was similar to that indicated by the surface dew points. Relatively dry air, with dew points at 850 millibars of less than 6° C., was found over most of Texas on April 1. At 0300 cst April 2 special radio-

sonde observations showed a rapid influx of moisture with dew points up to 10° C., the moist air having moved northward in a line from Laredo to San Angelo, Tex. By 0900 cst this moisture had shifted eastward to a line from Laredo to Austin, Tex., to Altus, Okla., with dew points increasing to 14° C. at Bryan, Tex., and to 12° C. at Fort Worth—an increase of 11° C. in 6 hours at the latter station. By 1500 cst the moisture and low-level jet axes nearly coincided from Galveston to Dallas to Altus. The maximum moisture gradient occurred in the vicinity of the quasi-stationary front in northern Texas. As mentioned before, the wind axis and low-level moisture axis formed the central axis of tornado activity, with the area beginning in the vicinity of the quasi-stationary front and spreading northward.

The isotherms at 850 millibars showed a general weakening of the warm front as it moved northward over Texas on the 1st; it became quasi-stationary in the vicinity of Dallas on April 2. The strongest thermal gradient on the 2d was associated with the cold front moving through west Texas.

4. 700-MILLIBAR CHARTS

On April 1 at 0900 cst, the 700-millibar chart (fig. 18) had a short-wave trough with a temperature of -2° C. in the vicinity of Little Rock, Ark. This trough was moving northeastward, while a second strong perturbation was moving down the western coast of the United States (figs. 19-24) carrying with it temperatures as low as -8° C. in the vicinity of Las Vegas, Nev. At the same time temperatures over Texas were 2° to 4° C., while winds over this region were mainly westerly. Twenty-four hours later at 0900 cst April 2, the western trough had intensified and a closed Low had formed with its center to the west of Albuquerque, N. Mex., and moving southeastward at 10 knots. Temperatures of 8° C. were now found at Tucson and Fort Huachuca, Ariz. Over Texas, however, temperatures were increasing to 10° C. at San Antonio, Bryan, Corpus Christi, and Brownsville. Strongest winds at this time were of the order of 50 knots and were

located on the western side of the trough. As the cold air from the west continued to move eastward, the temperatures over Texas increased, resulting in a sudden increase in the temperature gradient in western Texas and eastern New Mexico from 1° C. per 5° longitude to more than 10° C. per 5° longitude.

By 2100 cst on April 2 the Low had split into two parts with one center in western Colorado and the other southwest of Midland, Tex. Very dry air, with dew points of -10° to -26° C., was found over most of Texas, except where penetration of the 700-millibar level by the low-level moisture had occurred by 1500 cst in an area bounded by a line from Fort Worth to Abilene to Altus to Oklahoma City back to Fort Worth. In this area above zero dew points were indicated by the observations taken at 1500 cst. 700-millibar winds over Texas changed little in direction, with but a slight increase in speed.

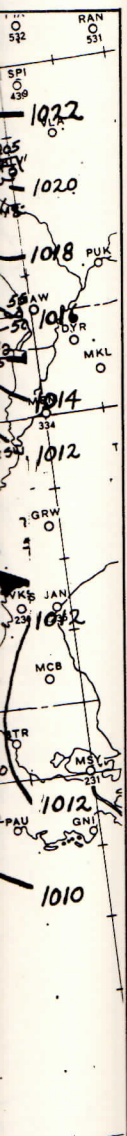

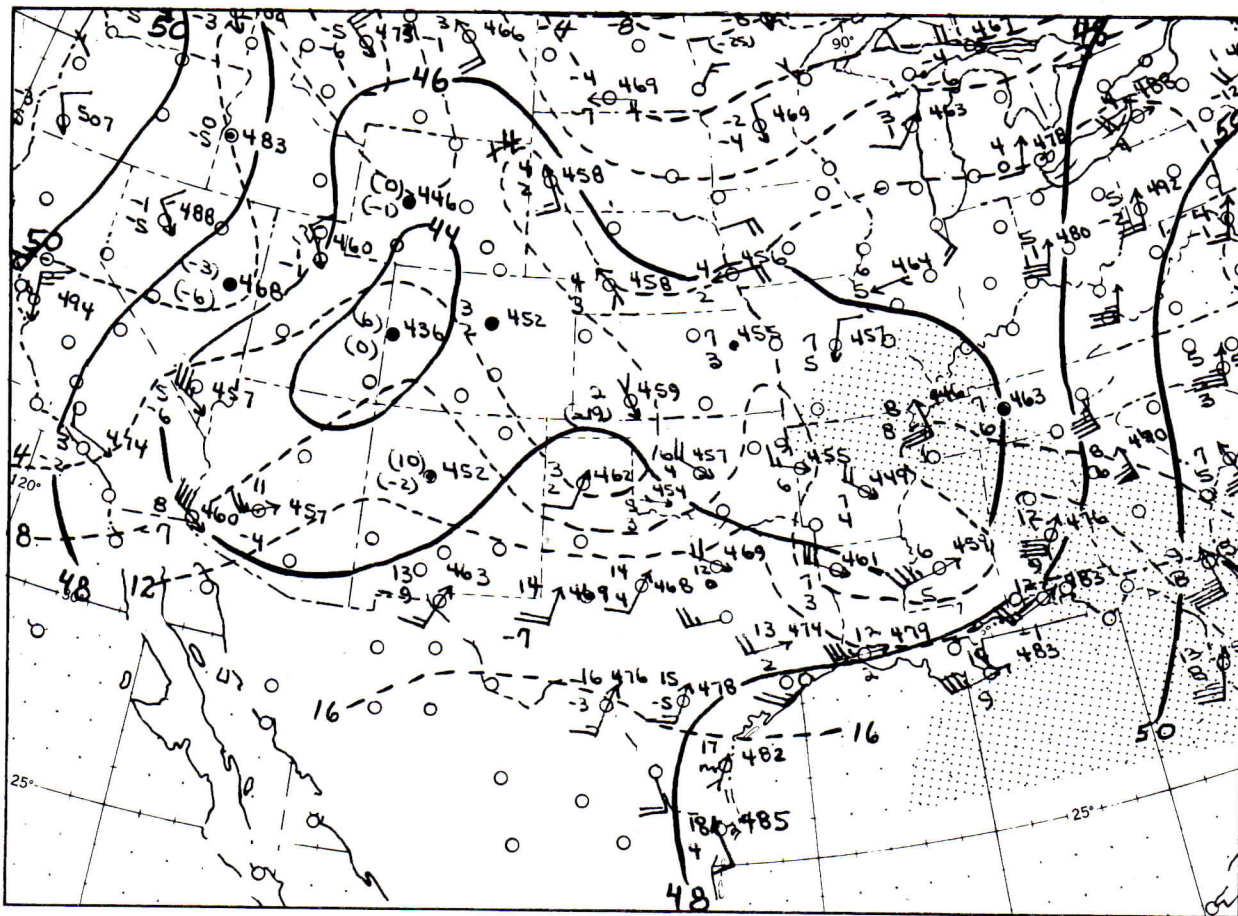

FIGURE 11.—850-millibar chart, 0900 CST, April 1, 1957. Contours (solid lines) are labeled in hundreds of feet, isotherms (dashed lines) in degrees Celsius. Dew point temperatures 6° C. or above are shown by light stipple, 12° C. or above by heavy stipple.

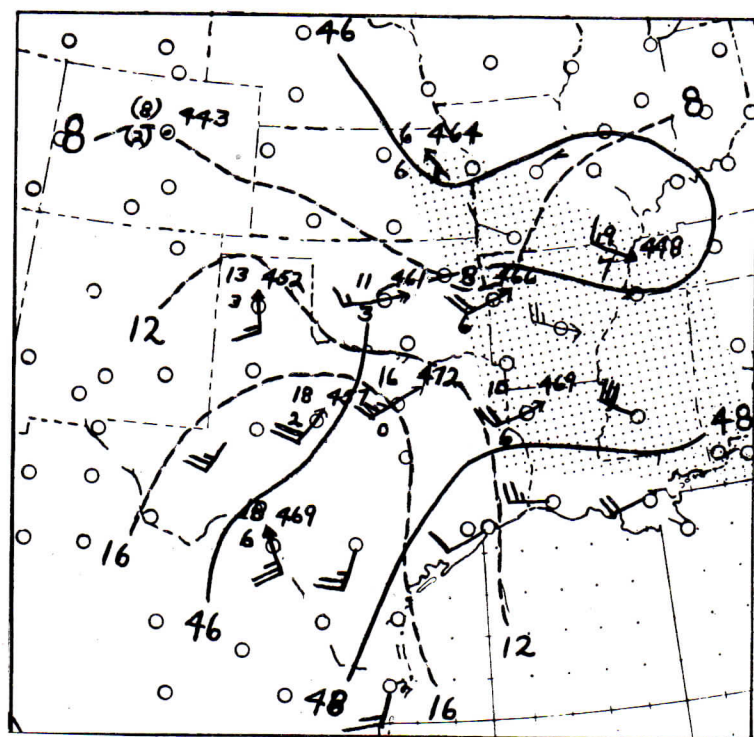

FIGURE 12.—850-millibar chart, 1500 CST, April 1, 1957.



FIGURE 13.

FIGURE 14.—



, 0900 CST,
 (d lines) are
 isotherms
 isus. Dew
 above are
 C. or above

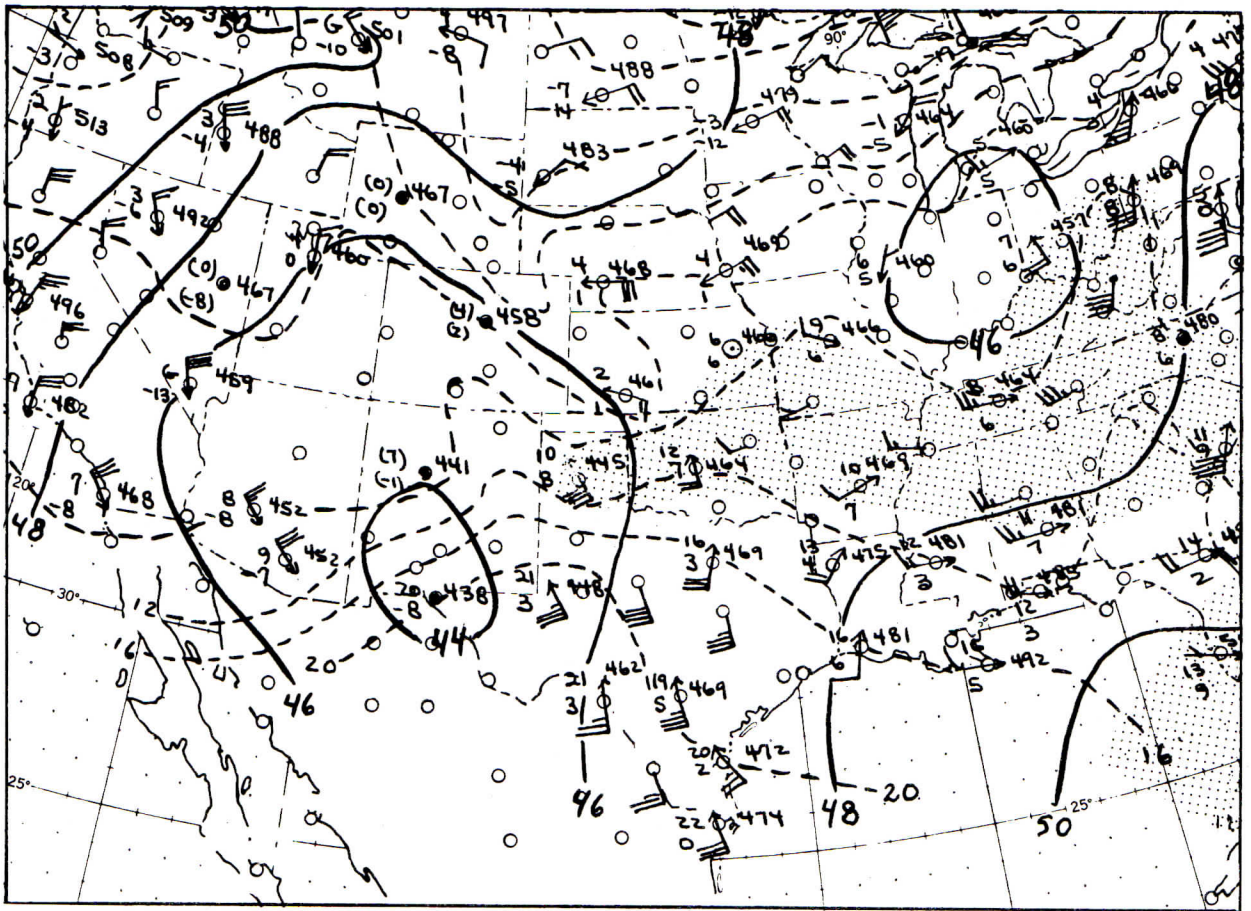

FIGURE 13.—850-millibar chart, 2100 CST,
 April 1, 1957.

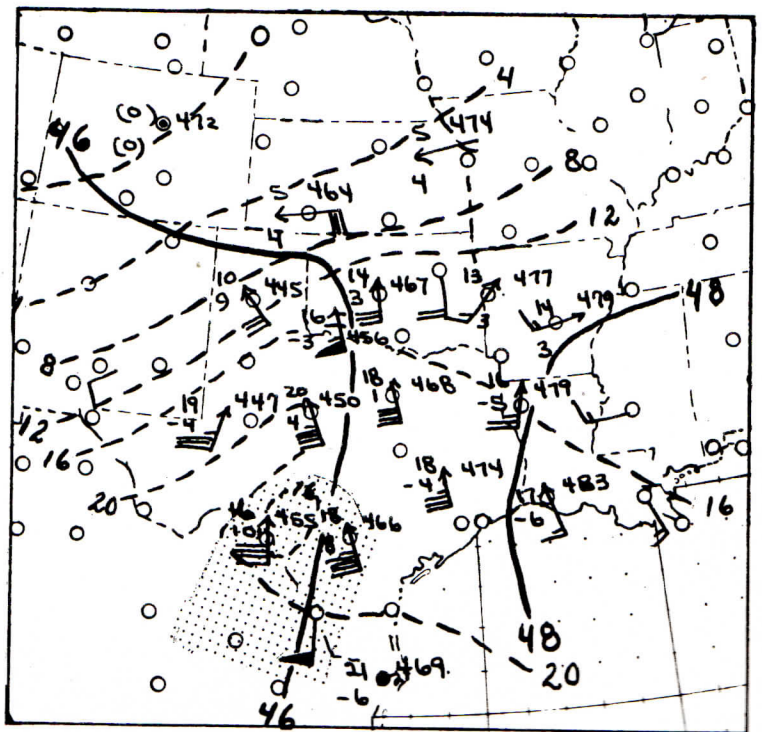

FIGURE 14.—850-millibar chart, 0300 CST,
 April 2, 1957.

, 1500 CST,

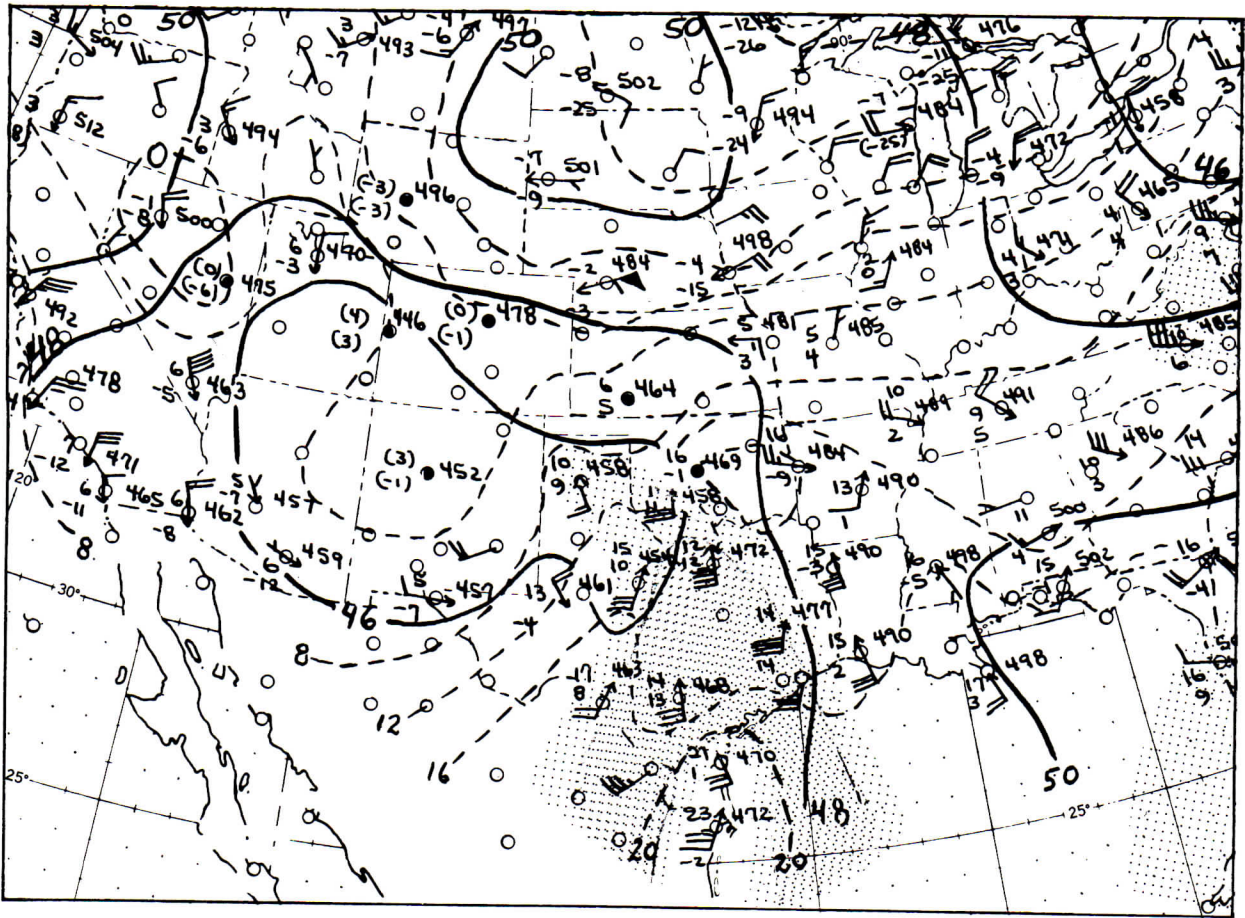

FIGURE 15.—850-millibar chart, 0900 CST, April 2, 1957.

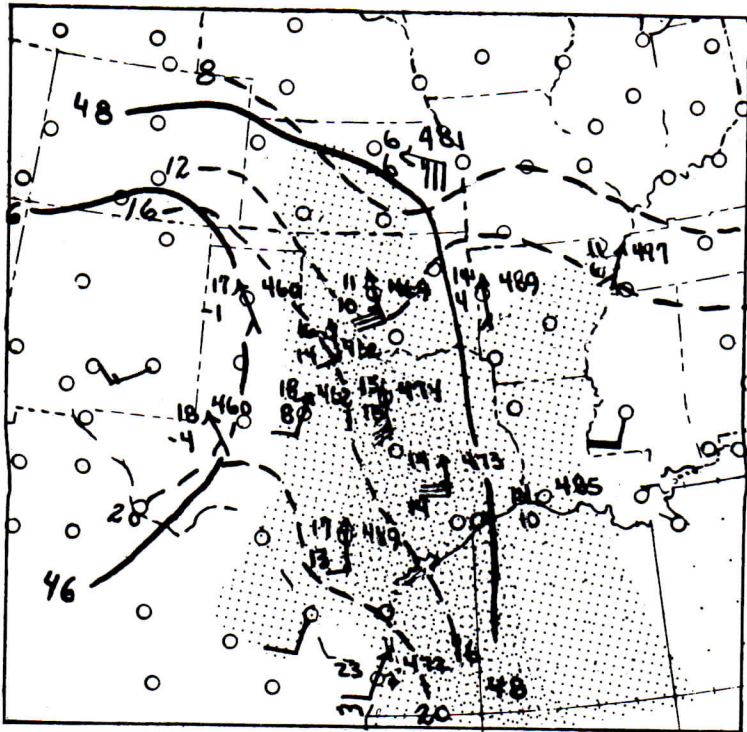

FIGURE 16.—850-millibar chart, 1500 CST, April 2, 1957.



FIGURE 18.—

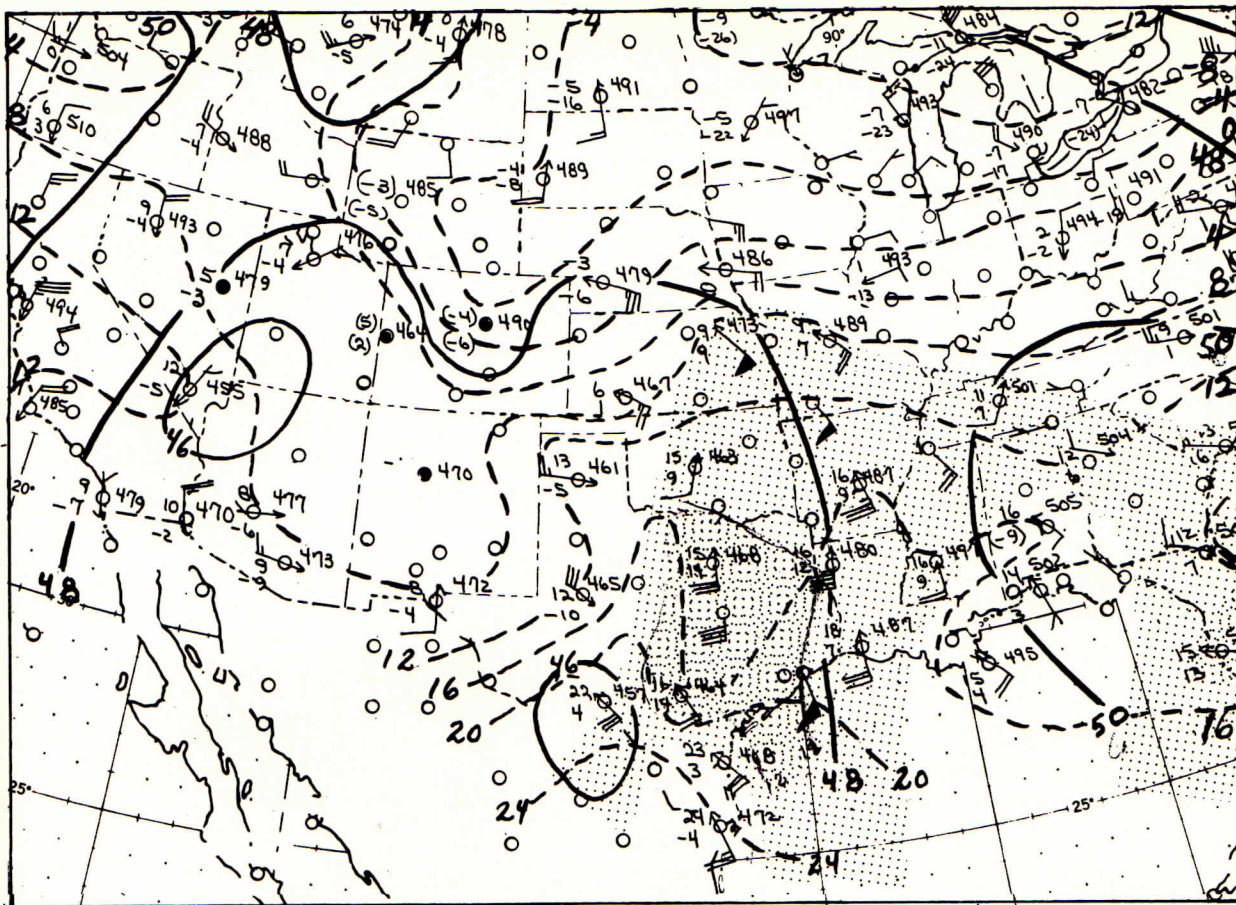
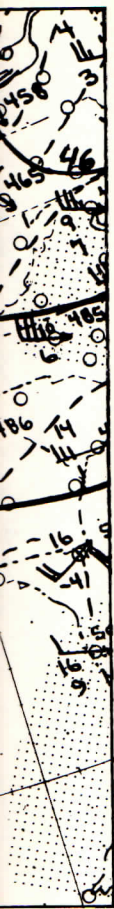
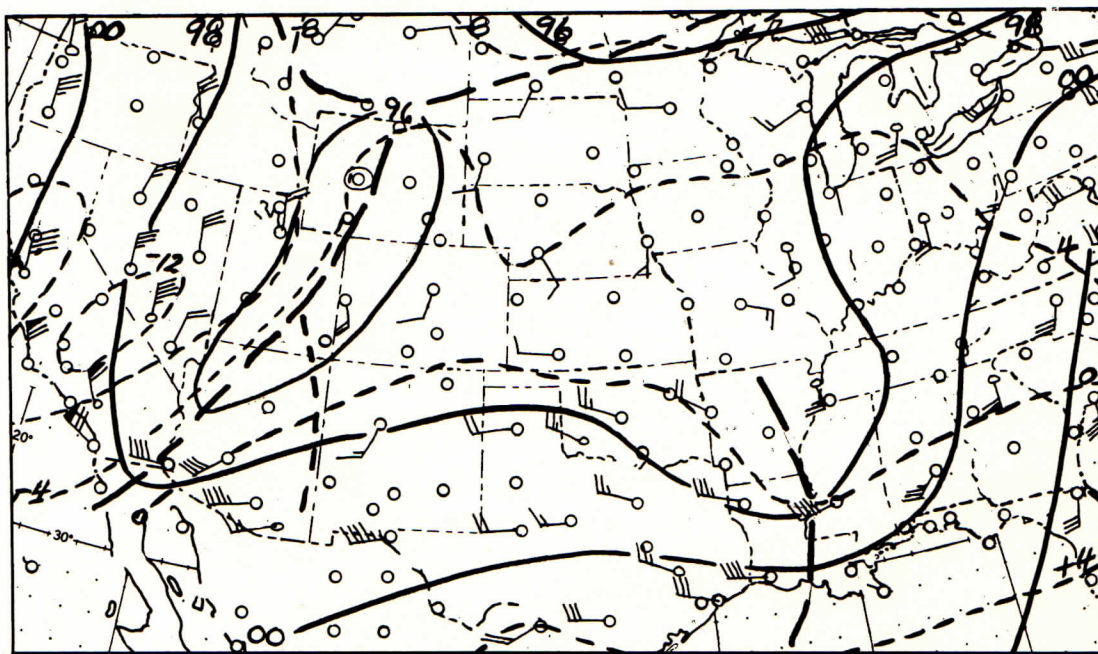

FIGURE 17.—850-millibar chart, 2100 CST, April 2, 1957.

t, 0900 CST,



t, 1500 CST,

FIGURE 18.—700-millibar chart, 0900 CST, April 1, 1957. Contours (solid lines) are labeled in hundreds of feet, isotherms (dashed lines) in degrees Celsius.

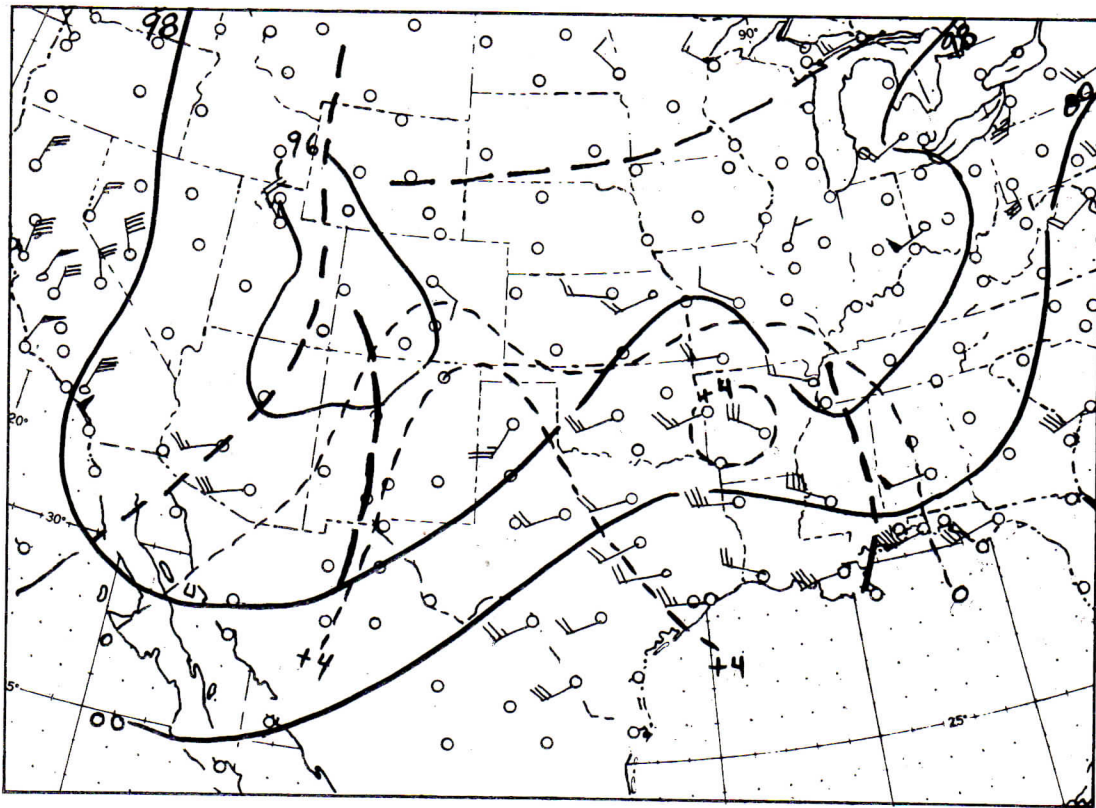

FIGURE 19.—700-millibar chart, 1500 CST, April 1, 1957.

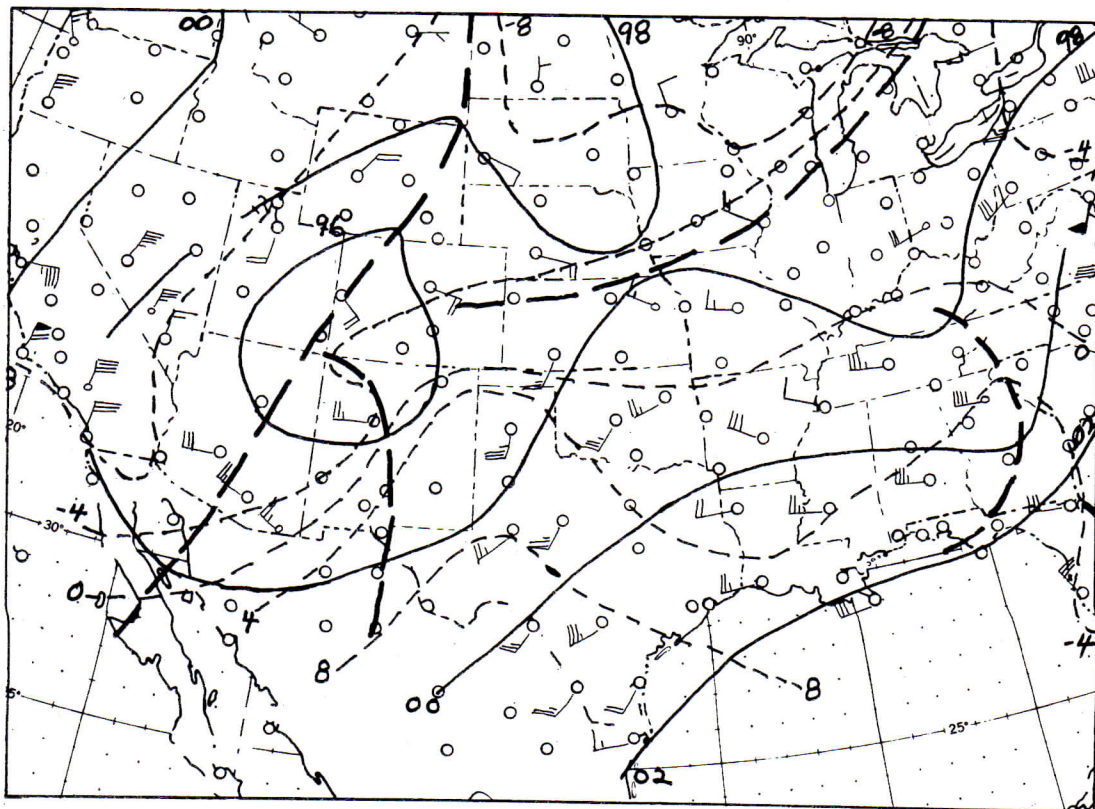

FIGURE 20.—700-millibar chart, 2100 CST, April 1, 1957.

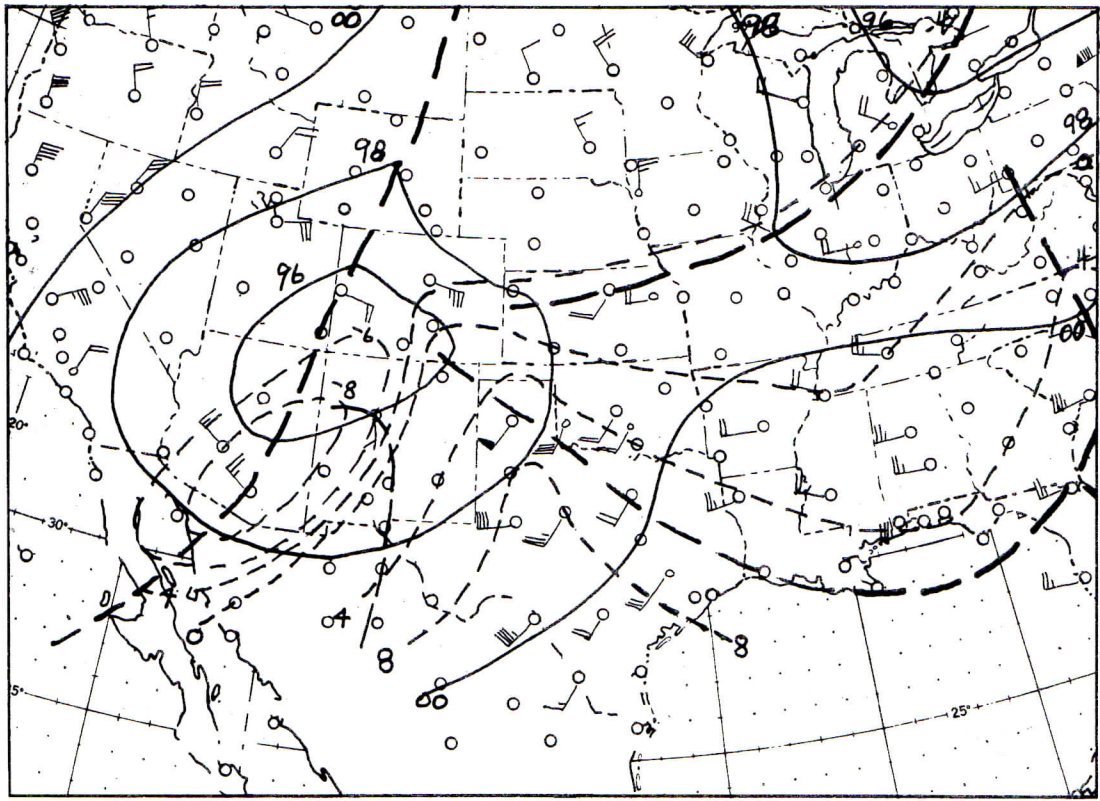

FIGURE 21.—700-millibar chart, 0300 cst, April 2, 1957.

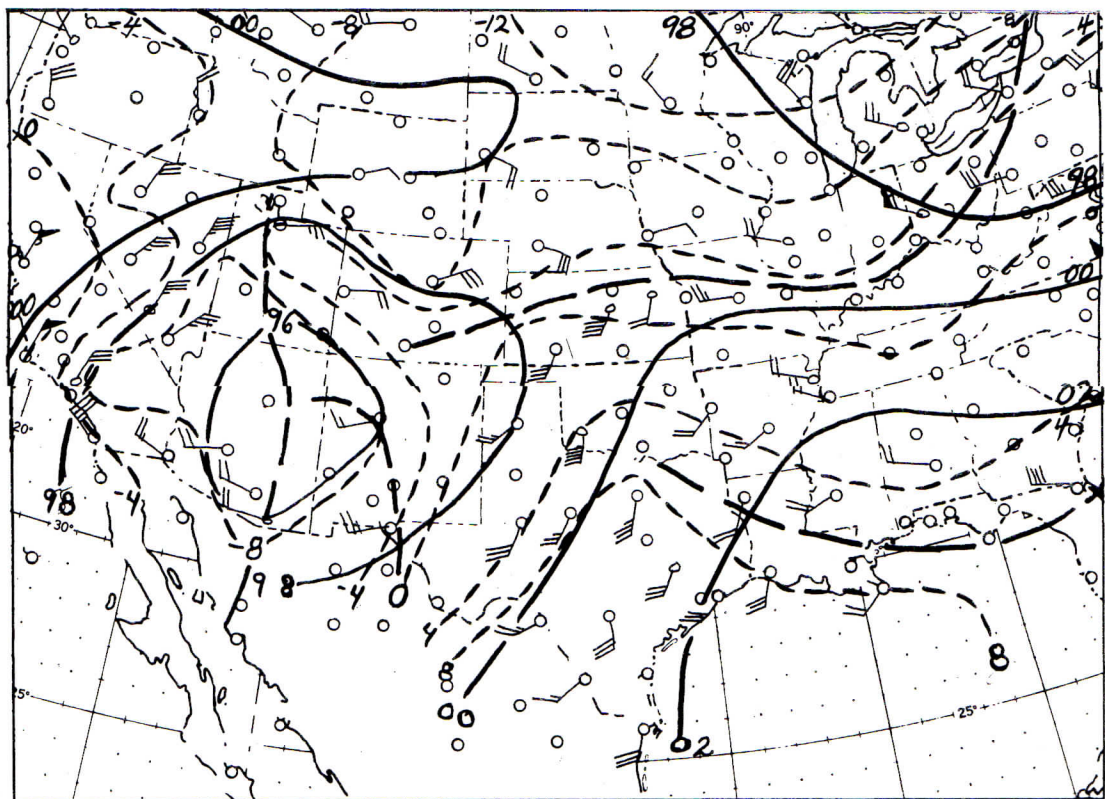

FIGURE 22.—700-millibar chart, 0900 cst, April 2, 1957.

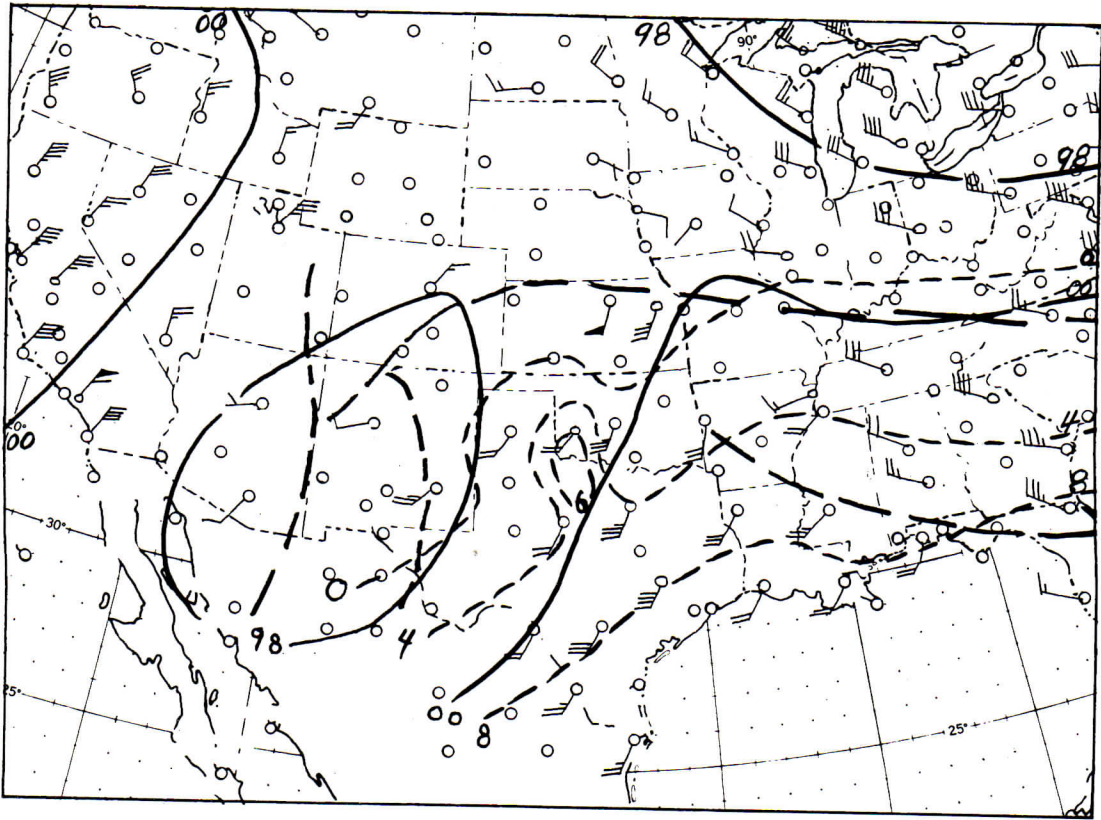

FIGURE 23.—700-millibar chart, 1500 cst, April 2, 1957.

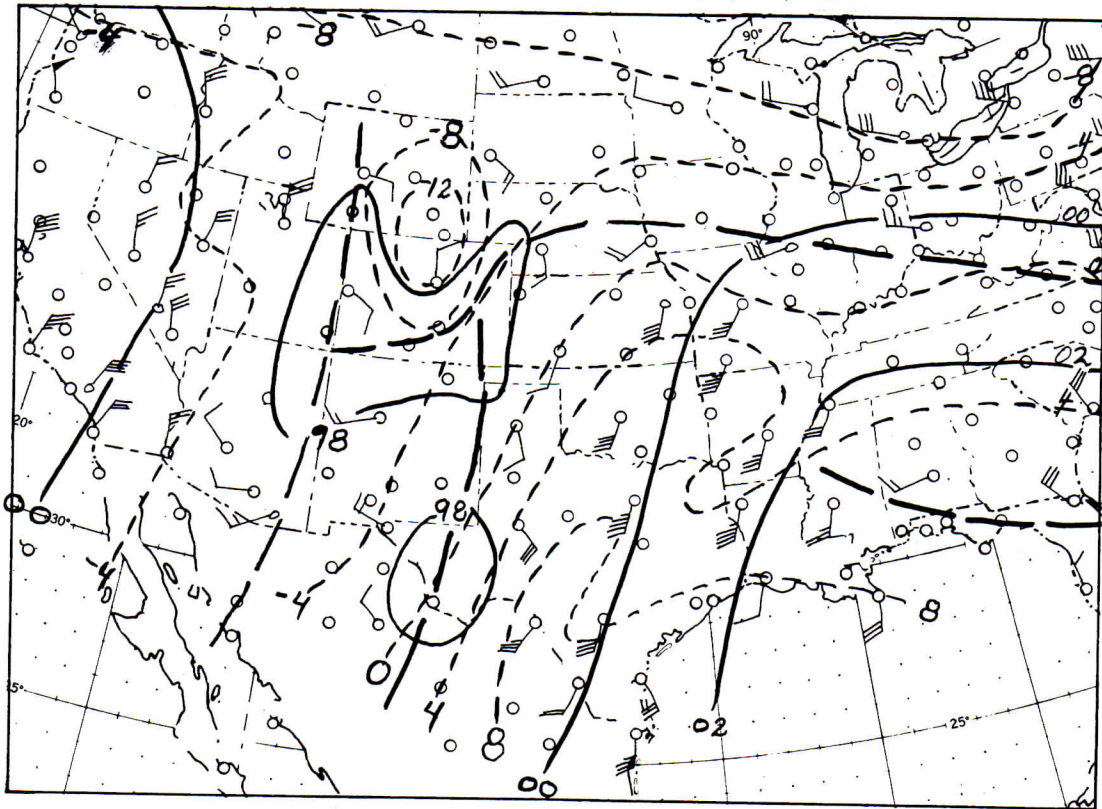

FIGURE 24.—700-millibar chart, 2100 cst, April 2, 1957.

A two-
the 500-r
of the C
into the
The sout
series of
of about
0900 cst
central T
far south
its southe
northeast
the United
out of the
175° W. w
peratures n
south-sout
located ove
1. Tempe
south as L
than 80 km
tions of th
The spe
decreased
cst April 2
western N
time report
C. The 5
central Nev
thence digg
pearing aga

From a s
[1] over Te
the air was
(not shown)
ysis workin
grams per
moisture in
mained stab
but a rapid
(fig. 33B) i
lower 3,000

5. 500-MILLIBAR CHARTS

A two-wave-train circulation was indicated on the 500-millibar chart—one wave moving north of the Canadian border and the other sweeping into the southern portions of the United States. The southern wave train was characterized by a series of perturbations moving through at a rate of about 8° latitude per day (figs. 25–32). At 0900 cstr March 31, a short-wave trough was in central Texas with temperatures of -19° C. as far south as Bryan, Tex. The trough had reached its southernmost penetration and was beginning a northeastward movement. On the west coast of the United States a second short wave, moving out of the long-wave trough position at about 175° W. was entering the coast with central temperatures near -30° C. This short wave dropped south-southeastward, with a closed circulation located over southwestern Utah by 0900 cstr April 1. Temperatures were as low as -29° C. as far south as Las Vegas, Nev., and winds were more than 80 knots in the southern and western portions of the trough.

The speed of movement of the closed center decreased to about 5° latitude per day by 0900 cstr April 2 when the center was located in northwestern New Mexico. Fort Huachuca at this time reported a 500-millibar temperature of -28° C. The 500-millibar jet was centered through central Nevada dipping into southern California thence digging southward into Mexico and reappearing again along a line from Midland to Ama-

rillo to Dodge City. From 2100 cstr April 1 to 0900 cstr on the next day, the 500-millibar temperatures were increasing over Texas with the largest rise a 6° C. increase in 12 hours at Amarillo. This was in contrast to the decrease of 7° C. in 12 hours recorded at Albuquerque, N. Mex. Extreme eastern Texas continued to warm during the day while the colder air moved into western Texas. By 2100 cstr, a 12-hour temperature fall of 5° C. occurred as far south and east as Del Rio, Tex. With this temperature gradient, winds of 50 knots or more were found as far east as Midland, Tex., at 0900 cstr, spreading eastward and reaching a line from Laredo to Fort Worth by 2100 cstr.

A weak perturbation apparently moved out of the main center at 1500 cstr and was situated along a line from Albuquerque to Lubbock, Tex. to a point northeast of San Antonio, Tex. (fig. 31). This perturbation advanced northeastward over the Dallas area to a line from north of Amarillo, through Oklahoma City, Okla., to north of Shreveport, La., by 2100 cstr (fig. 32) and to a line from Kansas City, Mo., to Little Rock, Ark., by 0900 cstr, April 3 (not shown). This perturbation, weak as it appeared at 500 millibars, continued eastward and deepened appreciably as it moved into the North Atlantic trough position.

A general area of diffluence was apparent over most of Texas during April 2.

6. RAOB ANALYSIS

From a study of the radiosonde observations [1] over Texas and Oklahoma, it was found that the air was generally stable at 0300 cstr, April 1 (not shown), as indicated on the SELS raob analysis working chart, with a mixing ratio of 9 grams per kilogram as the average maximum moisture in the lower 3,000 feet. The air remained stable at 0900 and at 1500 cstr (fig. 33A) but a rapid influx of moisture had by 2100 cstr (fig. 33B) increased the average moisture in the lower 3,000 feet to 14 grams per kilogram in

southern Texas and to 12 grams per kilogram in northern Texas. With this influx of moisture, the lifted index (LI) [2] dropped from near 0 at 1500 cstr to the very unstable value of -10 at 2100 cstr. By 0900 cstr April 2 (figs. 33C and 33D), the axis of maximum moisture in the lower 3,000 feet was—as indicated on the surface and 850-millibar charts—on an axis from west of Galveston to Dallas to Altus, Okla., with the most unstable air—as indicated by the LI—lying along an axis from Victoria, Tex., to west of Waco,

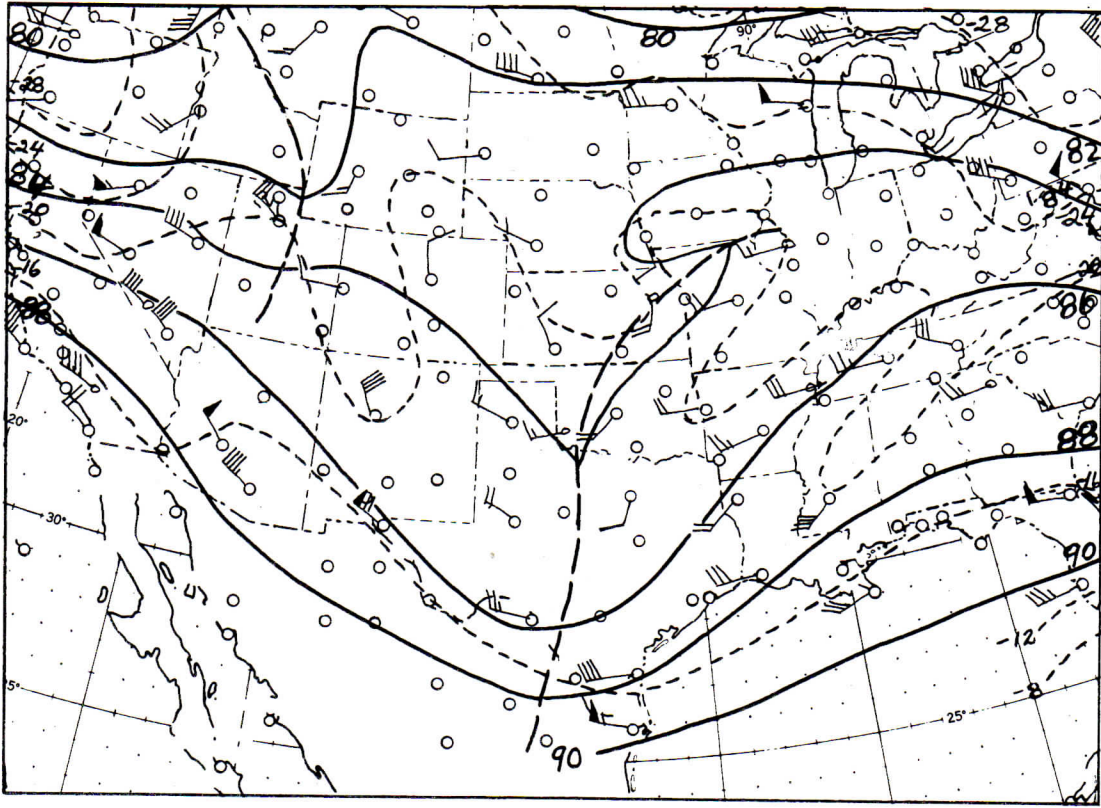

FIGURE 25.—500-millibar chart, 0900 CST, March 31, 1957. Contours (solid lines) are labeled in hundreds of feet, isotherms (dashed lines) in degrees Celsius.

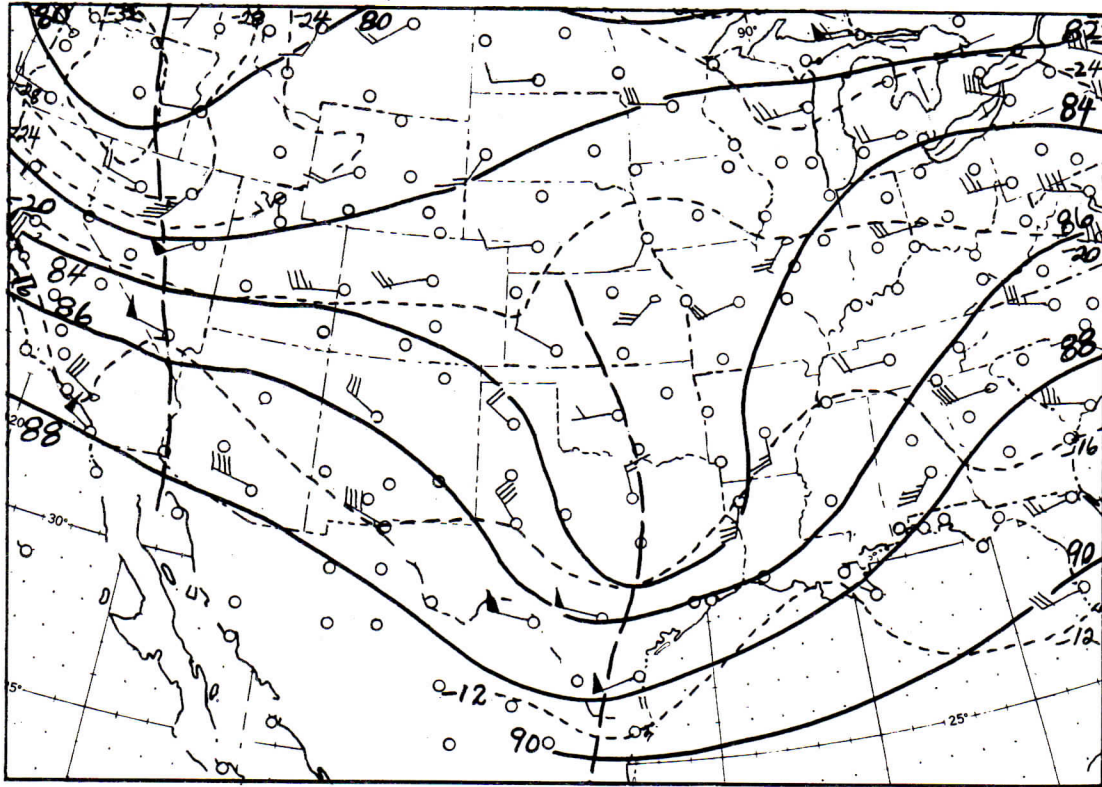

FIGURE 26.—500 millibar chart, 2100 CST, March 31, 1957.

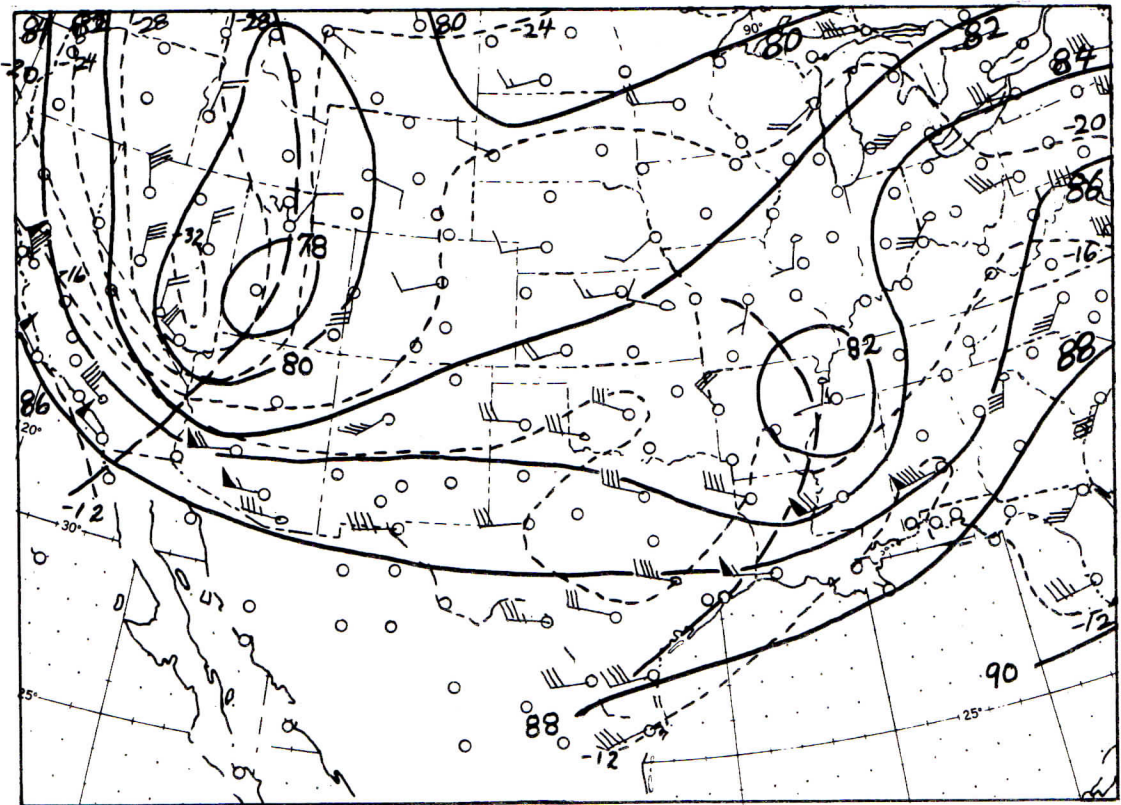

FIGURE 27.—500 millibar chart, 0900 cst, April 1, 1957.

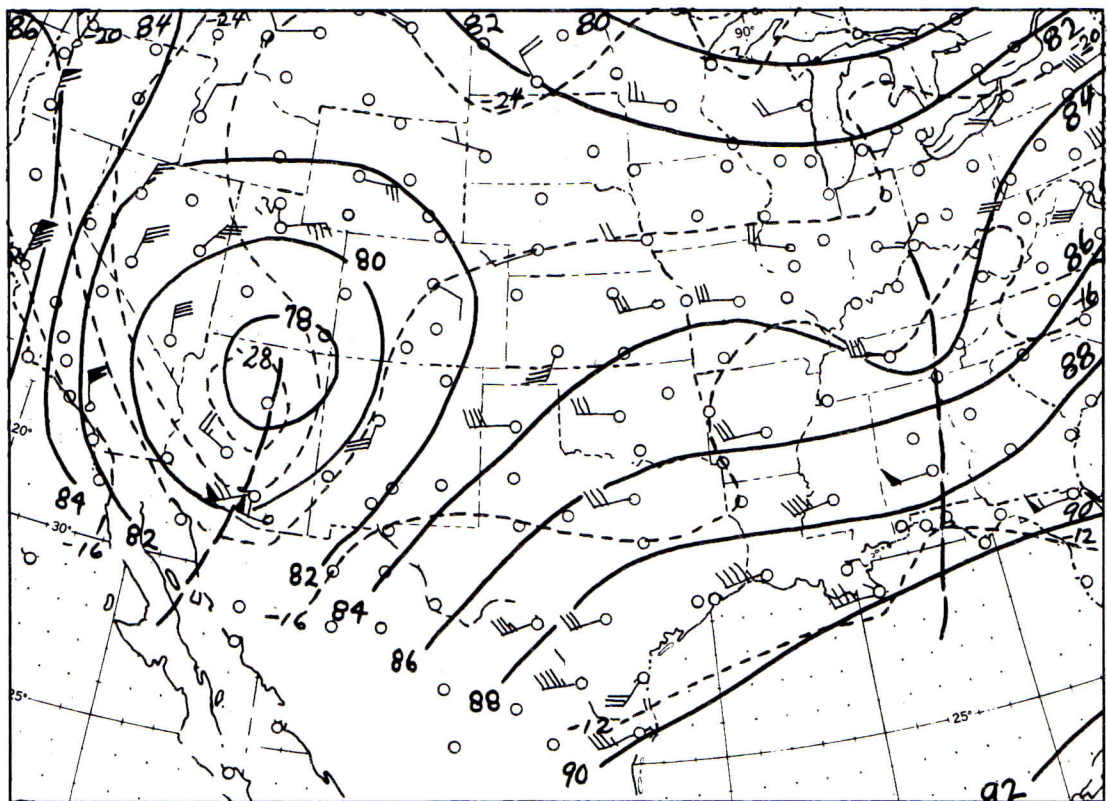

FIGURE 28.—500 millibar chart, 2100 cst, April 1, 1957.

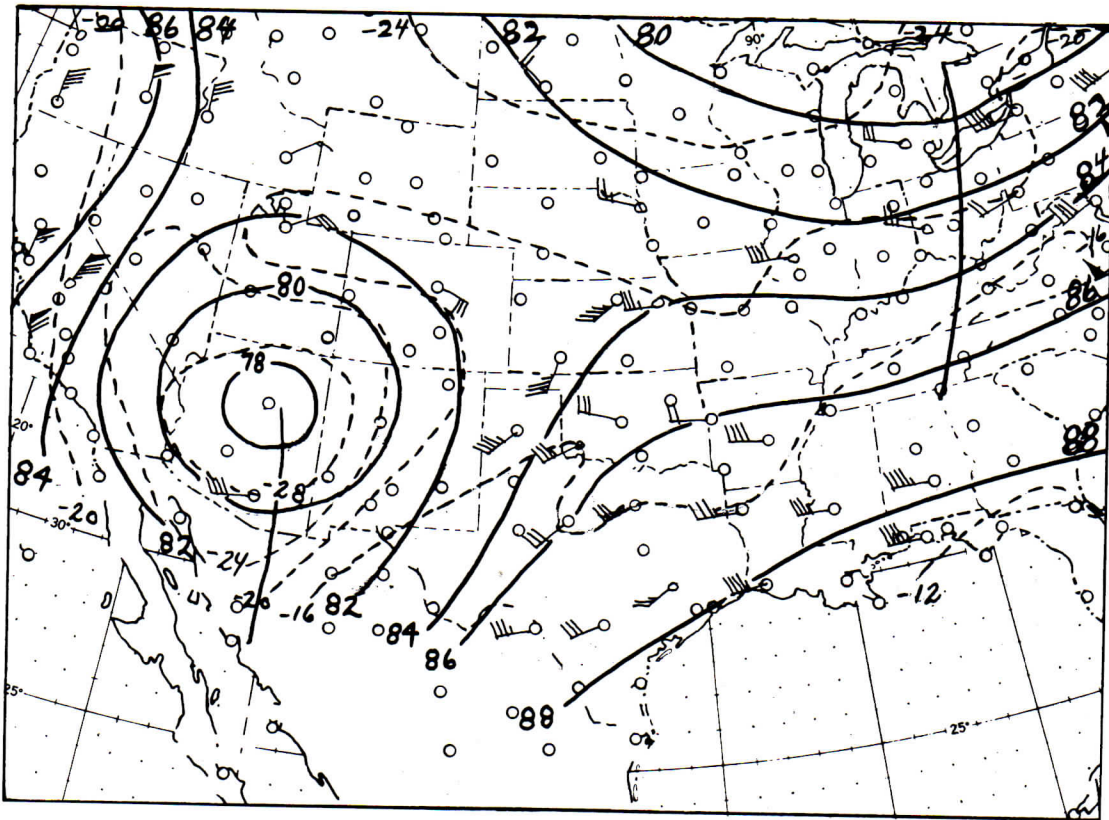

FIGURE 29.—500 millibar chart, 0300 cst, April 2, 1957.

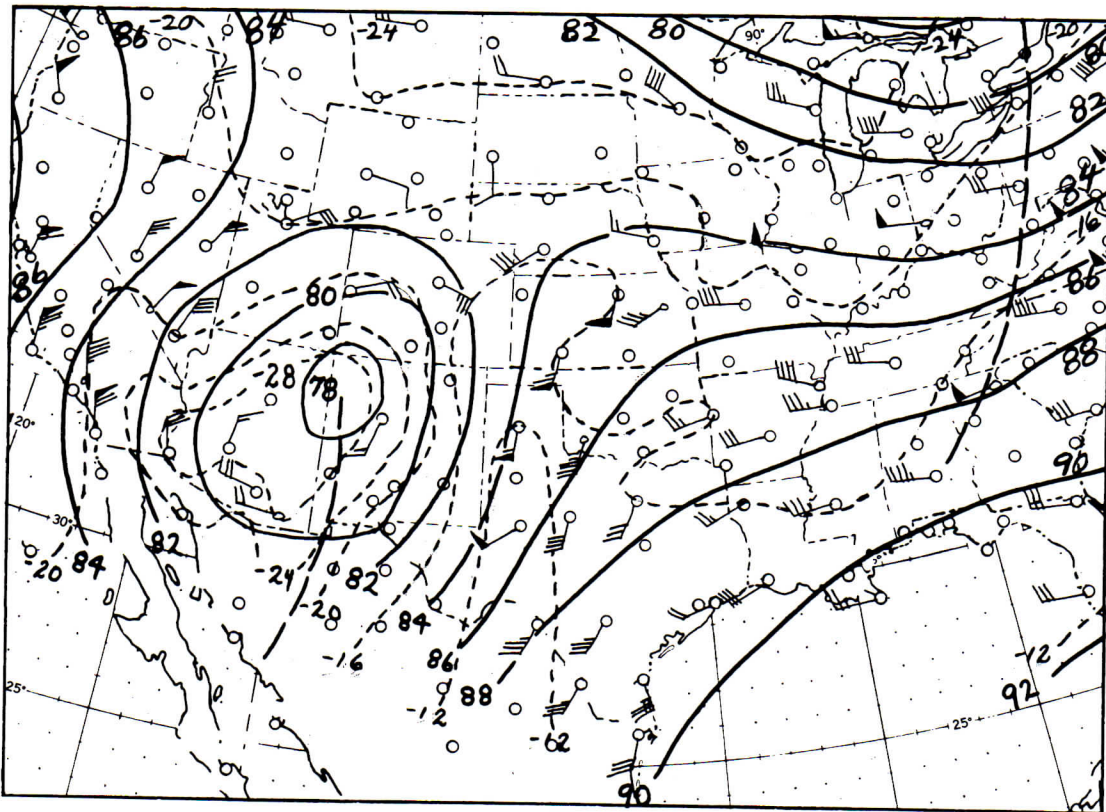

FIGURE 30.—500 millibar chart, 0900 cst, April 2, 1957.

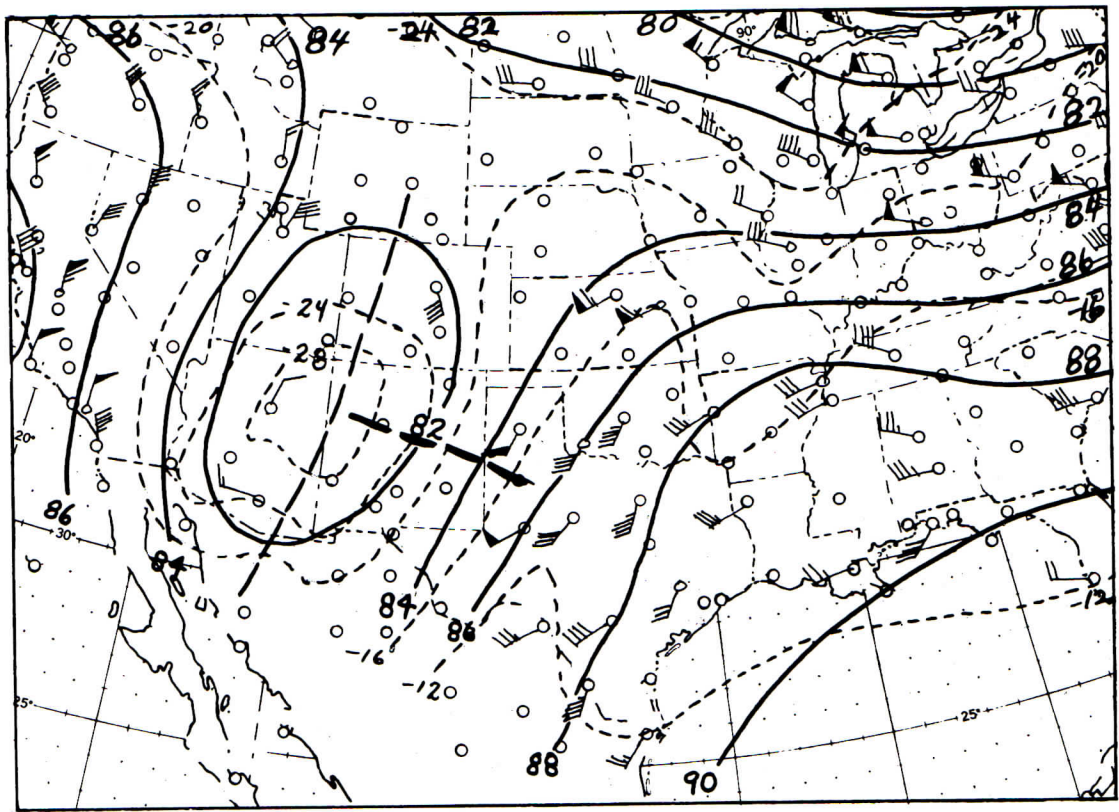

FIGURE 31.—500 millibar chart, 1500 cst, April 2, 1957.

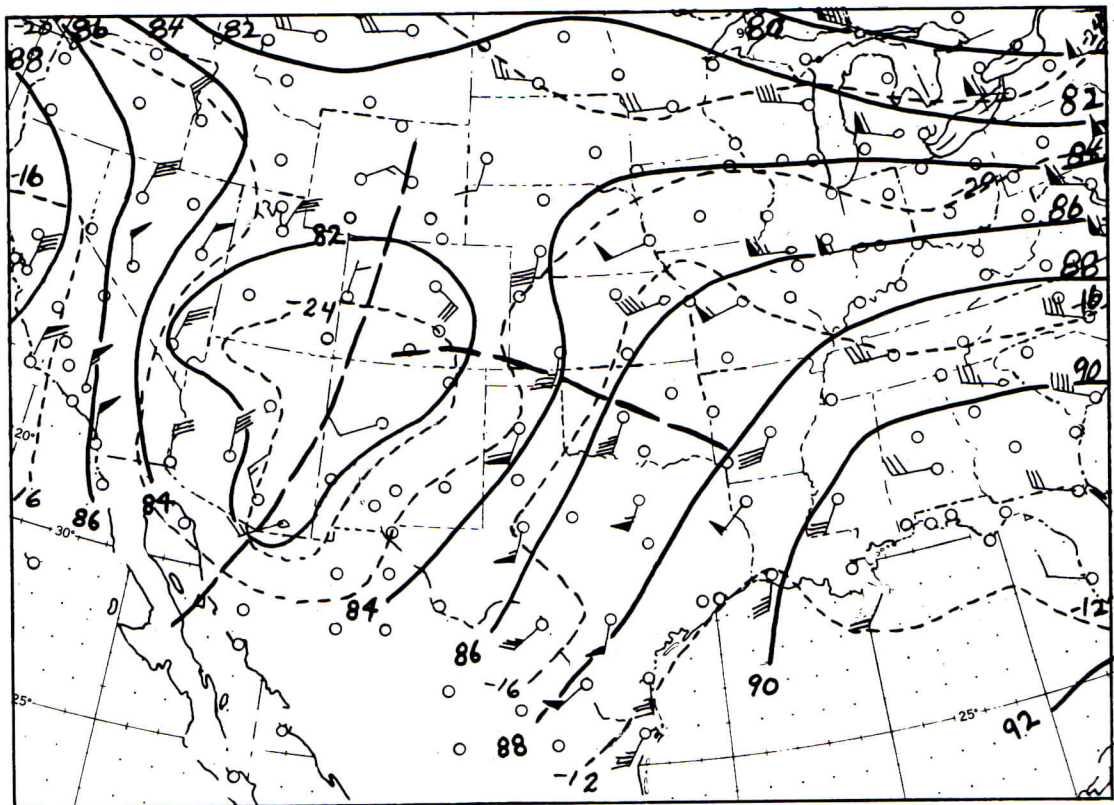

FIGURE 32.—500-millibar chart, 2100 cst, April 2, 1957.

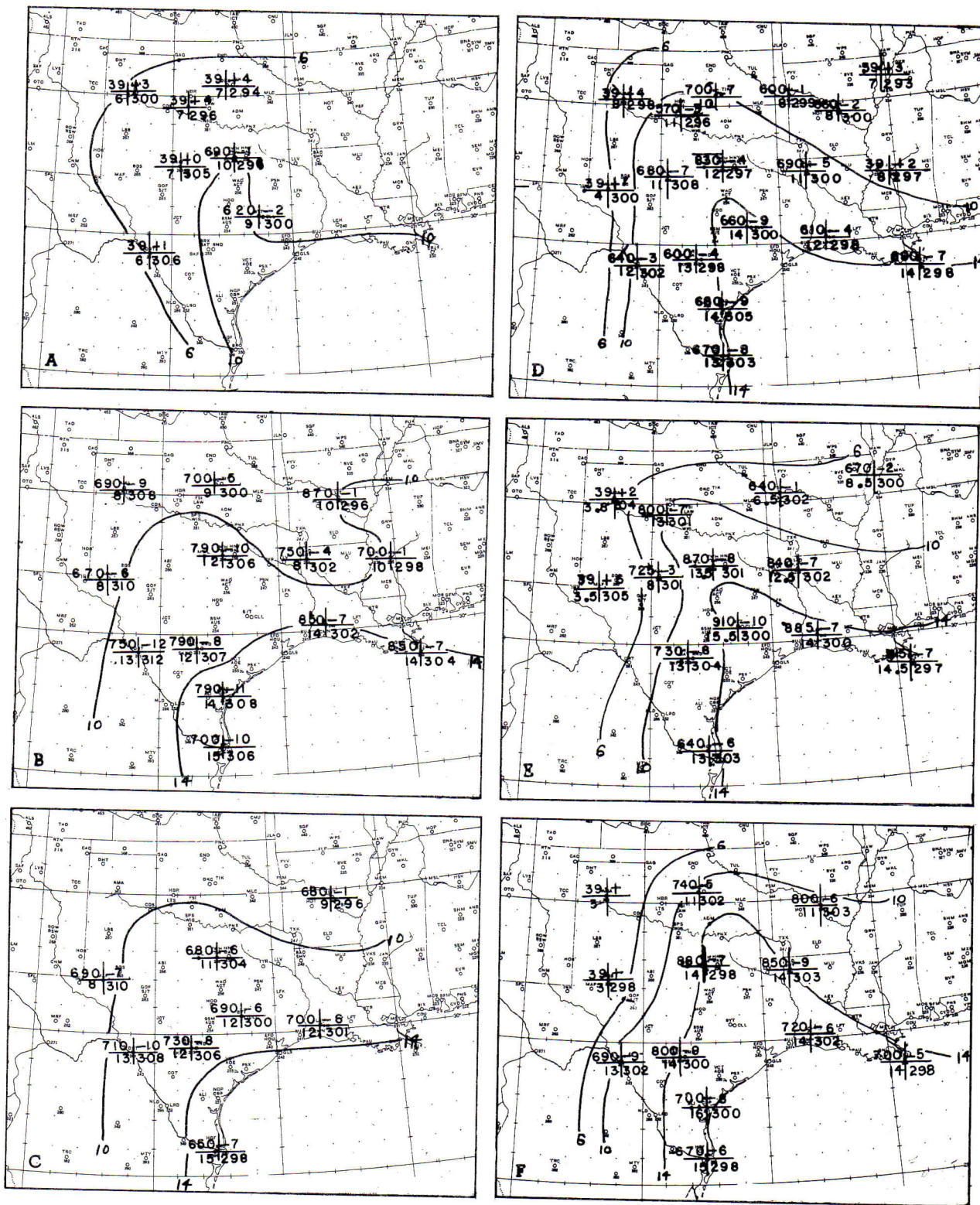

FIGURE 33.—RAOB analysis charts, 1500 cst, April 1, 1957. Level of free convection upper right, average mixing ratio of lower 3,000 feet, upper left on station model, lifted stability index lower left, average mixing ratio of lower 3,000 feet, lower right. Solid lines drawn for values of 6, 10, 14 grams per kilogram mixing ratio. (A) 1500 cst, April 1; (B) 2100 cst, April 1; (C) 0300 cst, April 2; (D) 0900 cst, April 2; (E) 1500 cst, April 2; (F) 2100 cst, April 2.

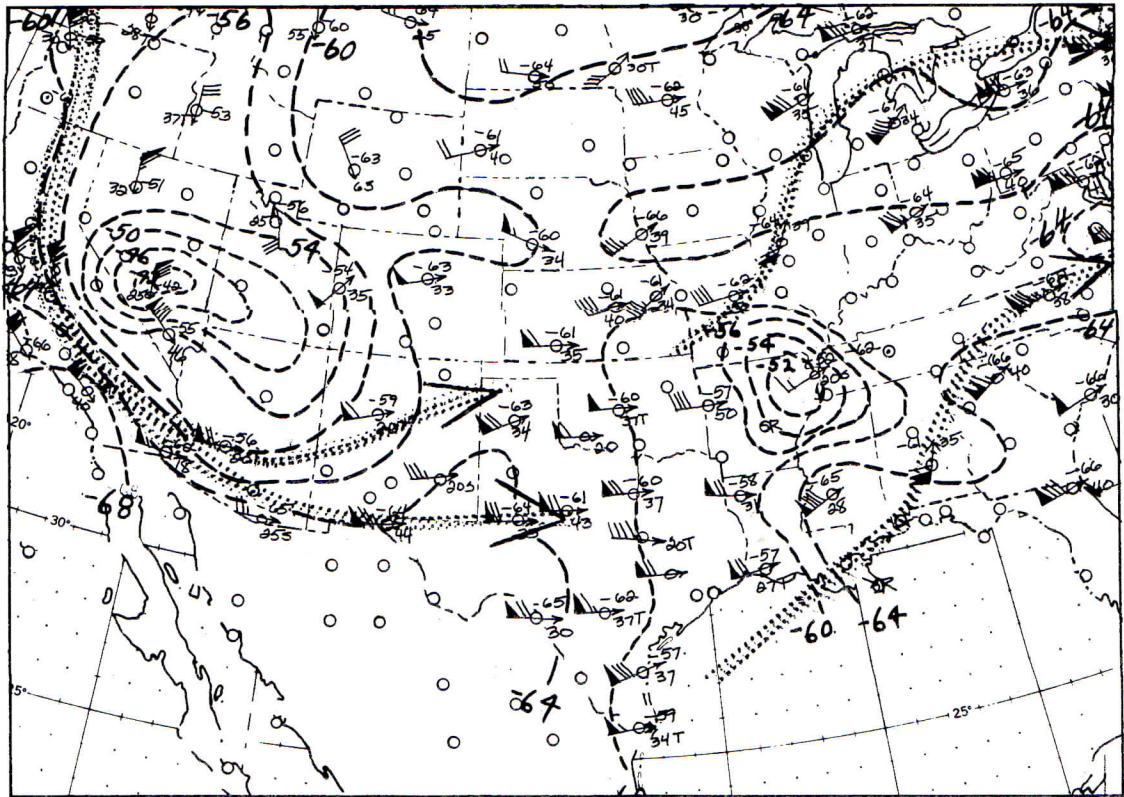

FIGURE 34.—Tropopause and jet chart, 0900 cst, April 1, 1957. Tropopause temperature (degrees Celsius) plotted above station circle, and field analyzed by dashed lines. Height of maximum wind plotted below station circle. Jets shown by stippled arrows.

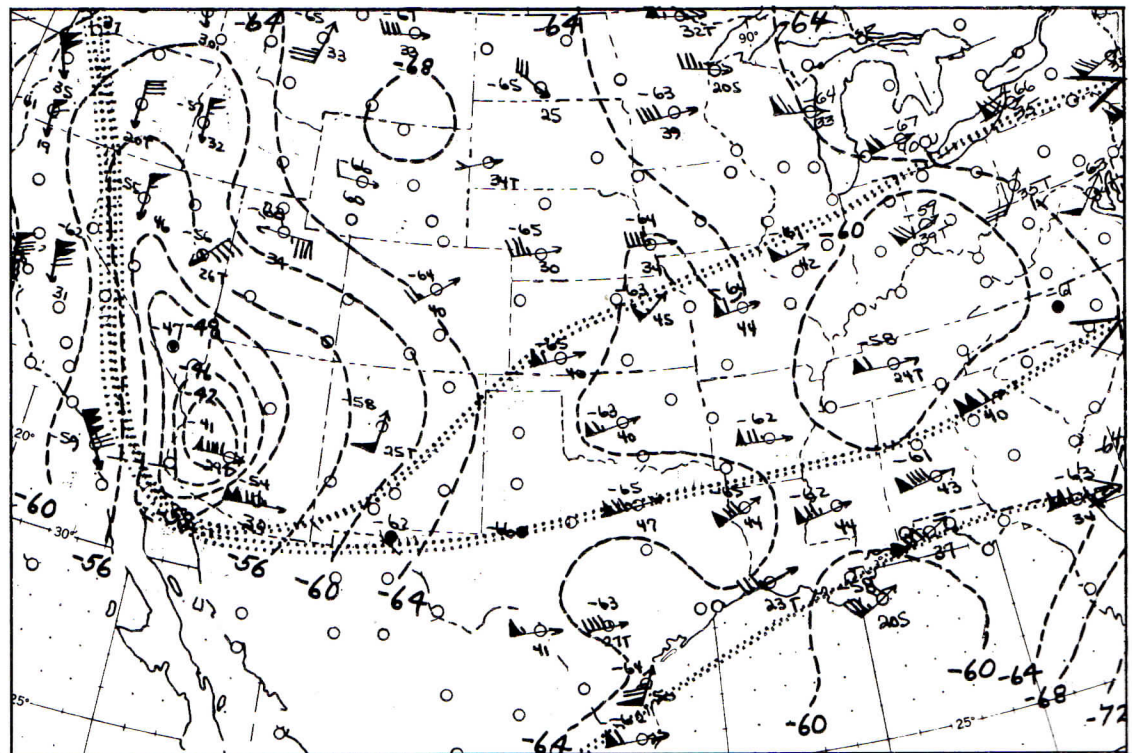

FIGURE 35.—Tropopause and jet chart, 2100 cst, April 1, 1957.

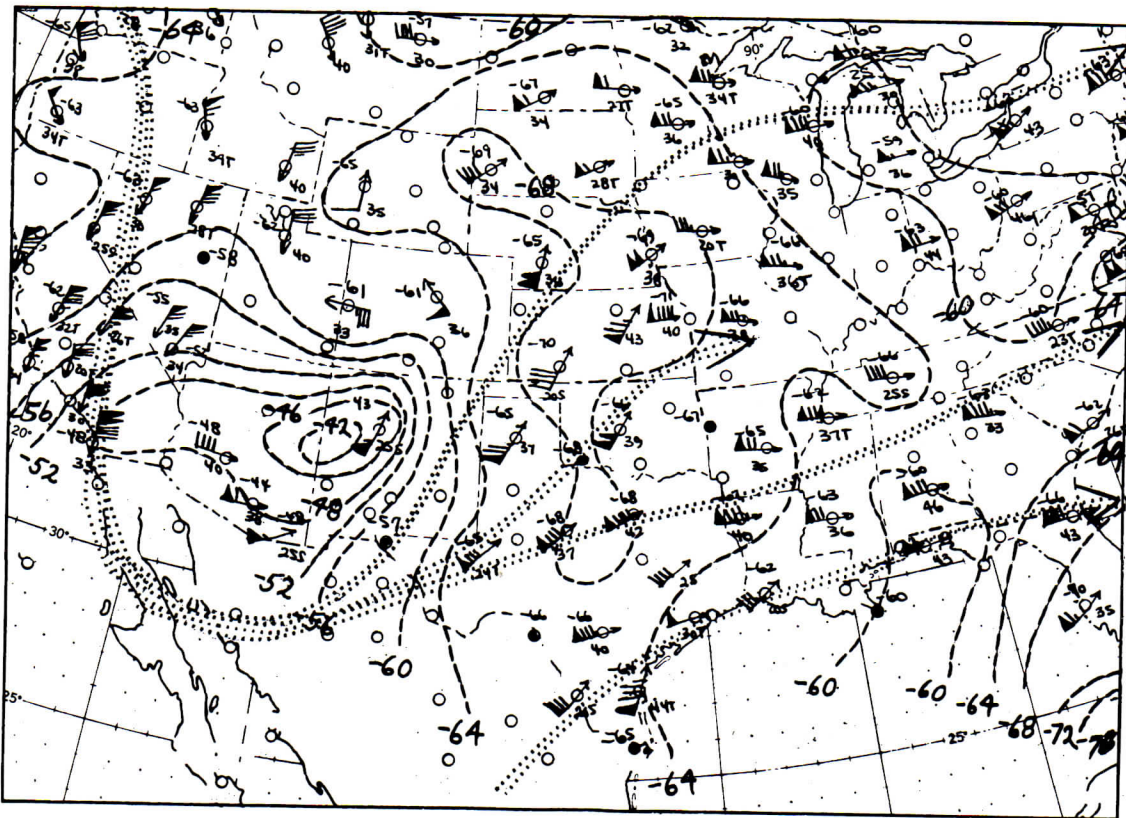

FIGURE 36.—Tropopause and jet chart, 0900 cst, April 2, 1957.

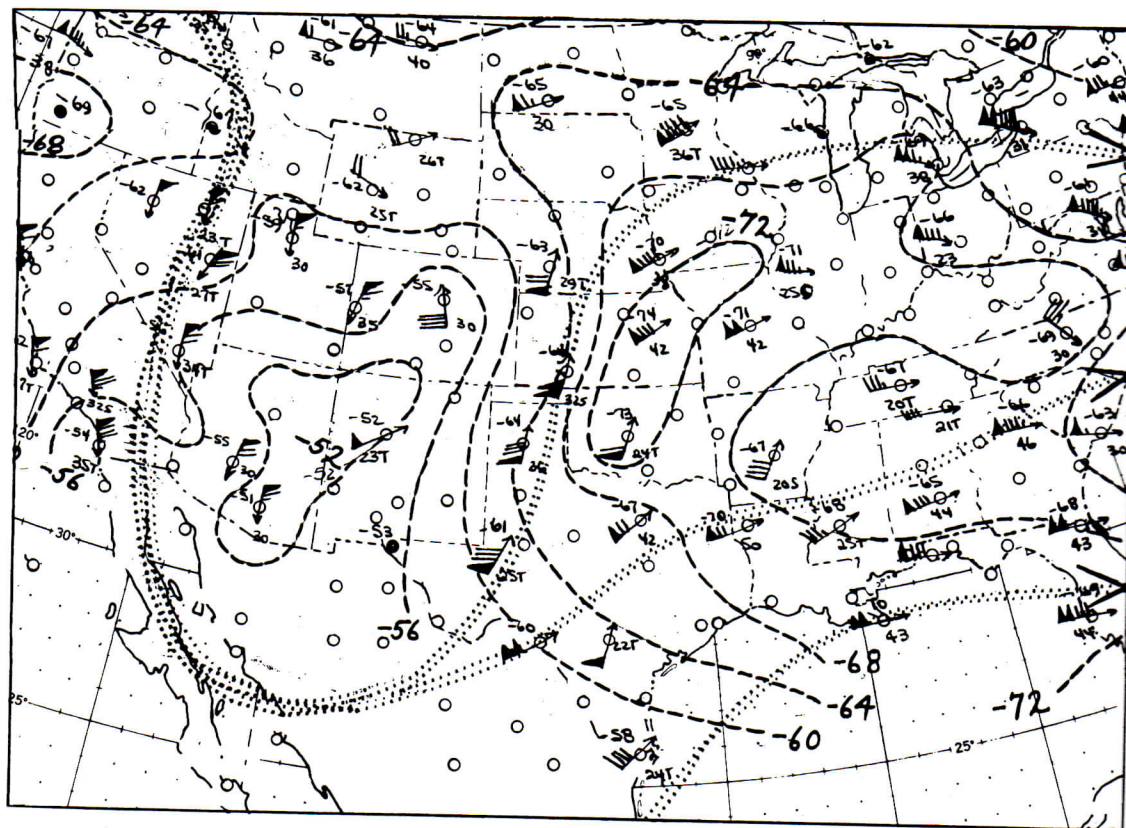

FIGURE 37.—Tropopause and jet chart, 2100 cst, April 2, 1957.

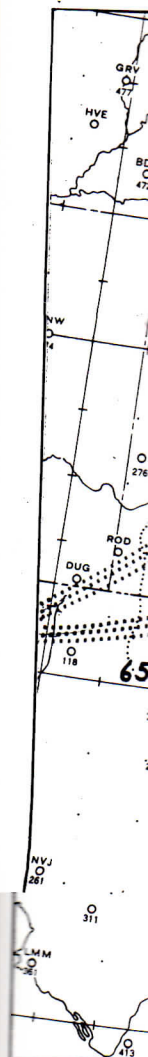

FIGURE 38.—
Surface temperature
(solid arrows)

Tex., to east
Tex., to Okl
33E), the a
maximum l
maximum u
west of Gal
the level of

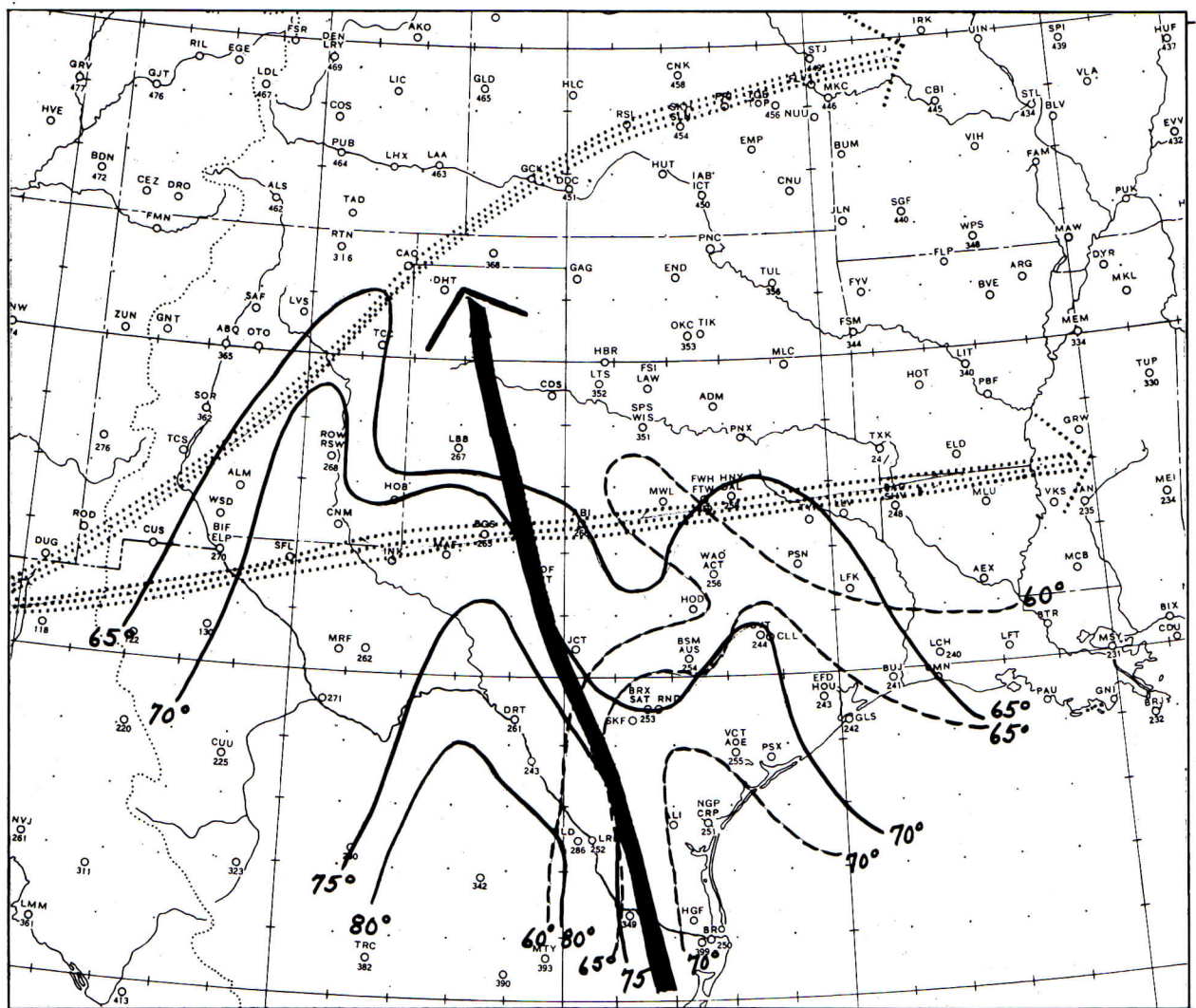

FIGURE 38.—Pattern of parameters generally used by SELS Center in forecasting severe weather, 2100 cst, April 1 1957. Surface temperature (solid lines), surface dew point (dashed lines), upper-level jet (stippled arrow), low-level jet (solid arrow).

Tex., to east of Abilene, Tex., to Wichita Falls, Tex., to Oklahoma City, Okla. At 1500 cst (fig. 33E), the axis had changed so that the axis of maximum low-level moisture and the axis of maximum unstable LI coincided in a line from west of Galveston to near Dallas to Altus, with the level of free convection becoming progres-

sively higher as the distance from the Gulf coast increased northwestward. At Fort Worth the level of free convection was at 870 millibars. As mentioned by Williams in the next paper there appeared over Texas a middle-level inversion. Figure 33F shows the airmass stability at 2100 cst.

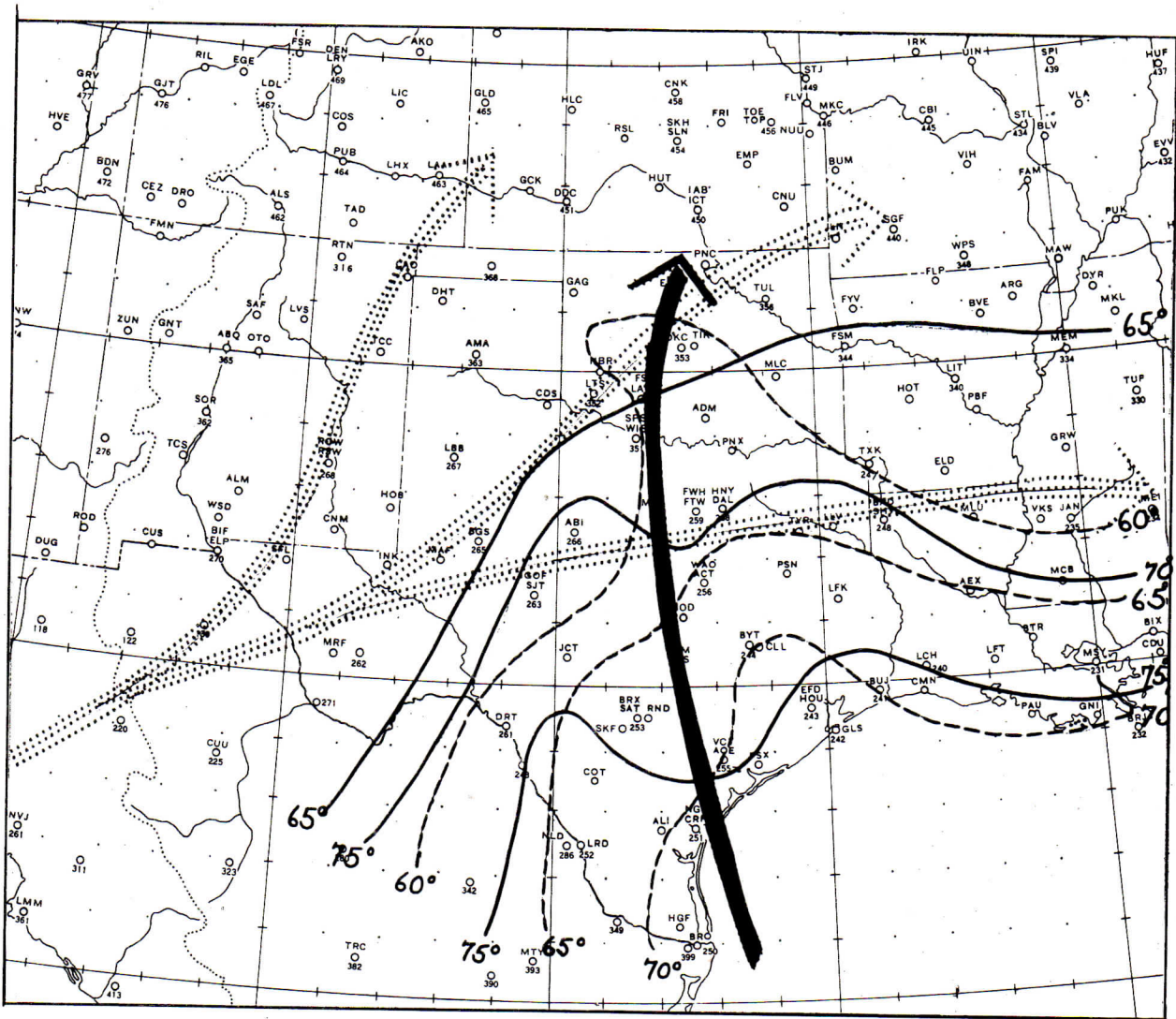

FIGURE 39.—SELS parameters, 0900 CST, April 2, 1957.

7. JET AND TROPOPAUSE CHARTS

Figures 34-37 are composite jet [3] and tropopause charts for April 1 and 2. A strong narrow band of winds of 100 knots or more had entered the west coast of the United States prior to 0900 CST April 1, with one jet maximum in central California as indicated by the wind speeds reported and by the maximum concentration of isotherms on the tropopause chart. This concentration moved to the Arizona-Mexico border by

2100 CST with a wind speed of nearly 180 knots reported at San Diego, Calif. The data at 0900 CST April 2 indicated one perturbation moving northeastward in the vicinity of eastern New Mexico and a second one remaining in southern California. The jet had a split configuration as indicated in figure 37 at 2100 CST April 2 and the apparent largest divergence aloft was at this time centered northeast of Dallas, Tex.

For simp
cluded in fi
sive positio
meters [1].
mentioned,
case was we
increased ra

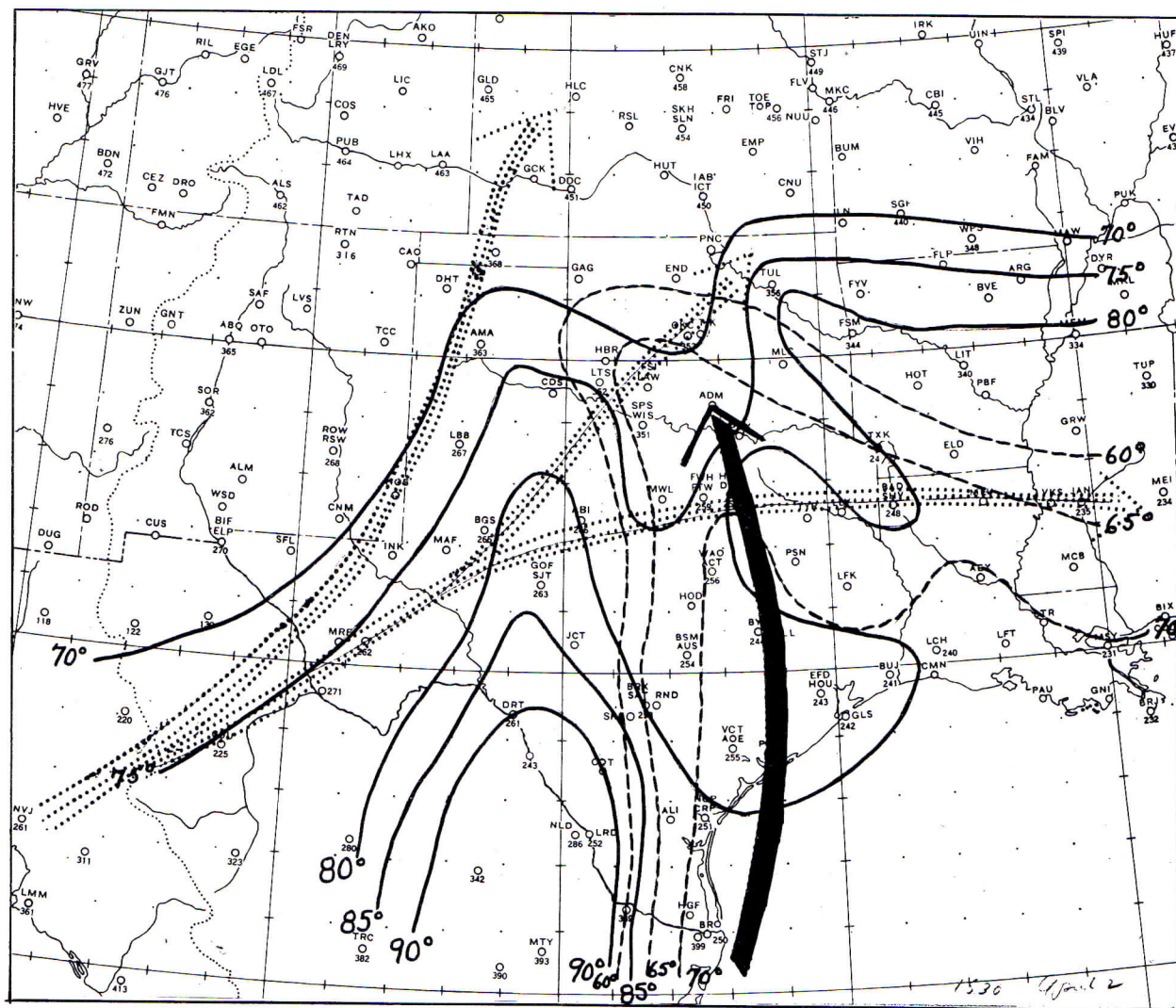

FIGURE 40.—SELS parameters, 1500 cst, April 2, 1957.

8. SUMMARY

For simplification frontal positions are not included in figures 38 to 40 which indicate successive positions of some SELS severe weather parameters [1]. As is shown, and as was previously mentioned, the low-level moisture, which in this case was well indicated by the surface dew points, increased rapidly over north-central Texas as the

temperature ridge moved eastward. Figures 33D and 33E show that the maximum instability occurred along this moisture axis. The low-level jet moved eastward and by late afternoon was in close proximity to the center of the moisture tongue. The upper-level jet indicates an area of divergence over the area of tornado activity.

REFERENCES

1. Staff Members of Severe Local Storm Forecast Center, "Forecasting Tornadoes and Severe Thunderstorms," *Forecasting Guide No. 1*, U.S. Weather Bureau, Washington, D.C., 1956, 34 pp. (see p. 15).
2. J. G. Galway, "The Lifted Index as a Predictor of Latent Instability," *Bulletin of the American Meteorological Society*, vol. 37, No. 10, December 1956, pp. 528-529.
3. J. T. Lee and J. G. Galway, "The Jet Chart," *Bulletin of the American Meteorological Society*, vol. 39, No. 4, April 1958, pp. 217-223.

The des
las, Tex.,
along a so
face disco
erally wea
the case, i
occurrence
might be r
air data. T
a study.

Upper-air
located just
tained from
1430, and 1
1710 CST. T
tray general
radius of t
pseudo-adial

From the
sections of p
ity, horizon
vertical mot

¹ Presented at
Meteorological S
² A synoptic st
search Paper)
was oriented we

THE ROLE OF A SUBSIDENCE LAYER¹

DANSY T. WILLIAMS

District Meteorological Office, U.S. Weather Bureau, Kansas City, Mo.

[Manuscript received June 19, 1957; revised April 28, 1958]

ABSTRACT

Although sufficient latent instability for severe thunderstorms was present in the Dallas, Tex., area as early as 0830 cst, April 2, 1957, the first tornado activity did not occur until shortly after 1500 cst. An earlier release of the instability was prevented by (1) a low-level temperature inversion, and (2) an intermediate-level subsidence layer. The temperature inversion was effective only during the morning hours; the subsidence layer alone retarded activity during the early afternoon. The tornadoes that occurred are believed to have resulted when the subsidence layer was briefly and locally penetrated, allowing a sudden, violent release of some of the instability. The passage of a wind shift line is believed to have effected this penetration.

1. INTRODUCTION

The destructive tornado that occurred at Dallas, Tex., April 2, 1957, apparently did not occur along a squall line or pressure jump line. Surface discontinuities in the Dallas area were generally weak and poorly defined.² Since this was the case, it was felt that an explanation for the occurrence of this and other tornadoes nearby might be revealed by a study of the local upper-air data. This paper presents the results of such a study.

Upper-air data from Carswell Air Force Base, located just west of Fort Worth, Tex., were obtained from the regular soundings at 0230, 0830, 1430, and 1930 cst, and a special sounding at 1710 cst. The soundings were assumed to portray general conditions within a 50-nautical-mile radius of the station. These are plotted on pseudo-adiabatic charts in figures 1-5.

From the data of these soundings time cross sections of potential temperature, relative humidity, horizontal advection of temperature, mean vertical motion, wind direction, and windspeed

were constructed. These are shown in figures 6-11 with time progressing from right to left. The height scale is linear with respect to pressure. The time-altitude position of each sounding is shown as a slightly tilted (30 minutes per 30,000 feet) line to account for the time required for the sounding balloon to ascend.

Severe thunderstorm activity occurring within the 50-nautical-mile radius of Carswell Air Force Base was summarized from the log of the Severe Local Storms Center, U.S. Weather Bureau, Kansas City, Mo., and is shown in table 1.

TABLE 1.—Severe thunderstorm activity occurring within a 50-nautical-mile radius of Carswell AFB, Fort Worth, Tex.

Time (cst)	Type of weather and location	Approximate distance (nautical miles) and direction from Carswell AFB
1508	Funnel cloud vicinity Grand Prairie.....	21 E
1555-1559	Tornado vicinity McKinney.....	48 NE
1638-1708	Tornado(es) Dallas vicinity.....	28 E
1832	Tornado 5-10 N. Meacham Field, Fort Worth....	11 NNE
1845	Tornado vicinity Azle.....	9 NW
1940-1951	Tornado vicinity Denton.....	35 NNE

¹ Presented at the 161st National Meeting of the American Meteorological Society, College Station, Tex., Nov. 13, 1957.

² A synoptic study by Mr. Jean T. Lee (elsewhere in this Research Paper) indicates that a weak quasi-stationary front was oriented west-east through the Dallas area.

2. UPPER-AIR CONDITIONS

STABILITY AND ENERGY

The air over a large portion of Texas, including the Dallas-Fort Worth area, was characterized by latent instability most of the day. As shown in figures 1-5, at Carswell AFB values of the lifted index [1] decreased from 0.0 at 0230 CST to -6.5 at 0830 CST and to -7.5 at 1430 CST. Indices of -7.0 were computed for 1710 and 1930 CST.³ The decrease in stability at Carswell AFB was due primarily to an increase in moisture in the lower levels.

The same parcels were lifted adiabatically (dry or moist, as appropriate) to show positive and negative energy areas on the charts. There was a rapid increase in the net positive energy area from 0230 to 1430 CST with a slight decrease thereafter. Top of the positive energy area increased from 31,500 feet at 0230 to 43,000 feet at 1710 CST, decreasing slightly thereafter. Except for the 0230 CST sounding the upper boundary of the positive energy area was the tropopause. Values of the lifted index, net energy area, and upper boundary of the positive energy area are shown in table 2.

TEMPERATURE

A low-level temperature inversion existed throughout the day, rising until the time of the 1710 CST sounding and falling thereafter. A time cross section of potential temperature, with the inversion indicated, is shown in figure 6. It may be noted from figures 1-6 that the low-level inversion was never quite eliminated, although it no longer constituted a negative energy area from somewhat prior to 1430 CST. Beebe and Bates [2] ascribe the lifting and gradual elimination of such an inversion to vertical motion.

³ The lifted index was computed according to operational procedures of the Severe Local Storms Center, U.S. Weather Bureau, Kansas City, Mo. In this procedure the mean moisture of the lower 3,000 feet and a forecast maximum surface temperature are used to determine the 500-millibar temperature of the lifted parcel. The lifted index is the difference between the temperature at 500 millibars of the sounding and the lifted parcel. In the case presented a forecast temperature of 78° F. (potential temperature of 300° A.) was used. Actual maximum temperatures reached during the day were: Love Field, Dallas, 77° F.; Carswell AFB, Fort Worth, 77° F.; and Amon Carter Field, Fort Worth, 76° F.

LOCAL CHANGE IN TEMPERATURE

The local change in temperature with respect to time, $\delta T/\delta t$, was approximated by subtracting temperature values of each sounding from those of the succeeding sounding at corresponding levels. Values of the local change in temperature, reduced to degrees Celsius per hour, are shown in table 3. A time cross section of the local temperature change is not included because the nature of this change may be noted from the isentropes in figure 6. The purpose of computing local temperature change was for subsequent use in the computation of mean vertical velocity by the adiabatic equation.

RELATIVE HUMIDITY

A time cross section of relative humidity is shown in figure 7. The extreme stratification of moisture and its coincidence with the low-level temperature inversion may be noted. The existence of moisture to great heights (72 percent

TABLE 2.—Energy potential of the Carswell AFB soundings. Net energy area is given in units of degrees Celsius times feet

Time (CST)	Lifted Index ° C.	Net energy area	Upper boundary of energy area (feet)
0230.....	0.0	-55,000	31,500
0830.....	-6.5	105,000	40,500
1430.....	-7.5	240,000	41,000
1710.....	-7.0	235,000	43,000
1930.....	-7.0	185,000	41,500

TABLE 3.—Local change in temperature with respect to time. Values are in ° C. per hour

Level (millibars)	0230-0830 CST	0830-1430 CST	1430-1710 CST	1710-1930 CST
Surface.....	0.45	0.71	-0.15	-0.26
950.....	.33	.63	.00	-.35
900.....	-.87	.47	.26	-.30
850.....	-.97	.29	.63	-.43
800.....	.37	-.83	-.04	.00
750.....	.33	-.83	-.19	.00
700.....	.20	-.55	.00	1.22
650.....	.12	.02	-.89	.96
600.....	.05	.15	.14	.04
550.....	.00	.20	.37	-.09
500.....	-.10	.25	.56	-.26
450.....	-.05	.55	.11	-.57
400.....	.20	.23	.15	-.17
350.....	.17	.17	.44	-.09
300.....	.33	-.03	.67	.39
250.....	.33	-.17	.56	1.00

FIGURE 1.— winds are shaded. in the cro lifted inde °F. and t

10
12
15
17
20
25
30
35
40
50
400
450
500
550
600
650
700
750
800
850
900
950
1000
1050
1500
PRESSURE
PRESSURE
546

URE

with respect
y subtract-
ding from
responding
n tempera-
e hour, are
tion of the
led because
d from the
computing
sequent use
velocity by

umidity is
ification of
e low-level
The exist-
72 percent

FB soundings.
Celsius times

Energy	Upper boundary of energy area (feet)
000	31,500
000	40,500
000	41,000
000	43,000
000	41,500

respect to time.

1710-1930 CST	
.15	-0.26
.00	-.35
.26	-.30
.63	-.43
.04	.00
.19	.00
.00	1.22
.89	.96
.14	.04
.37	-.09
.56	-.26
.11	-.57
.15	-.17
.44	-.09
.67	.39
.56	1.00

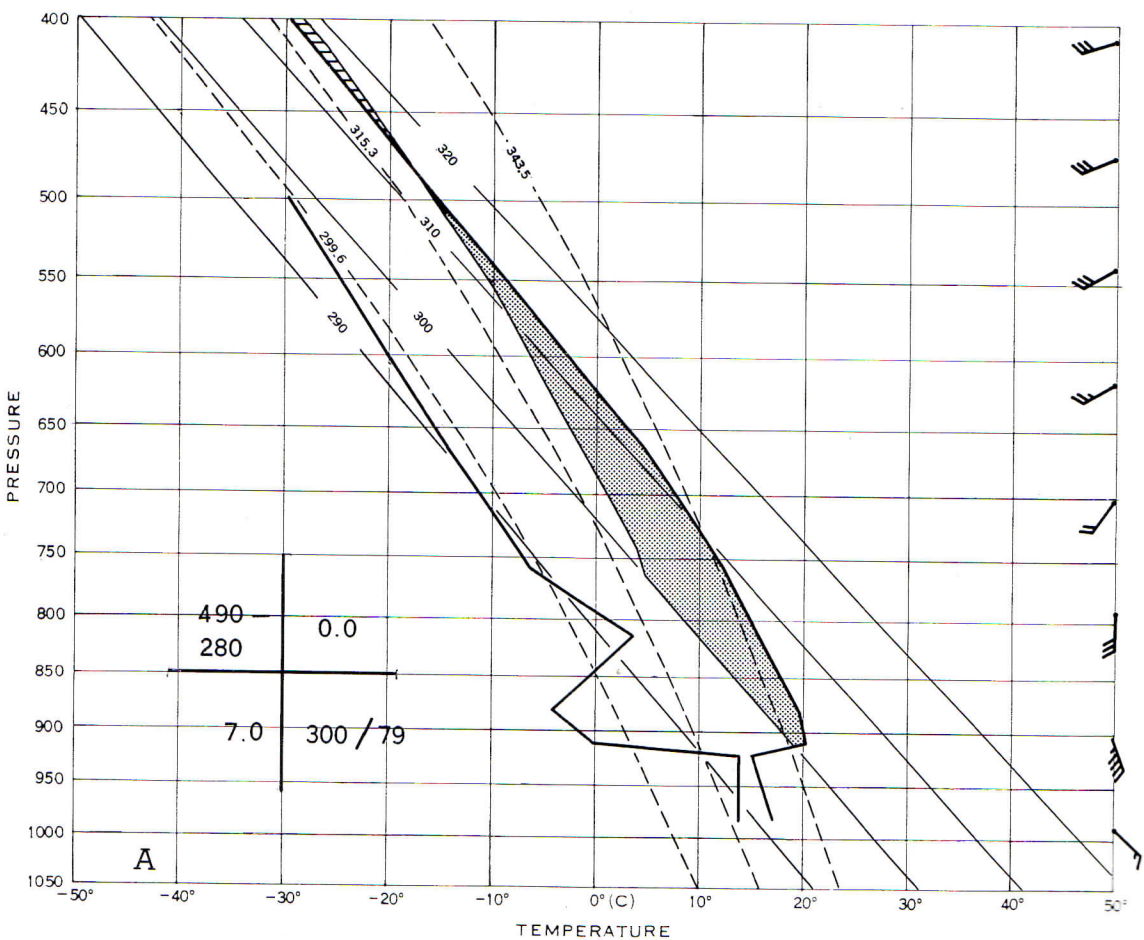
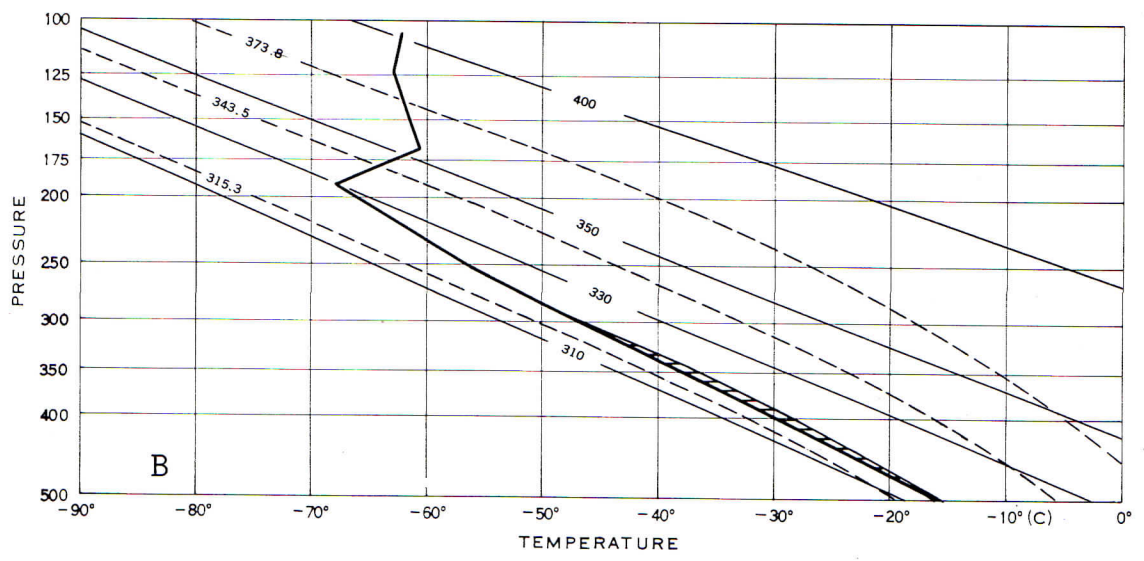

FIGURE 1.—Carswell AFB sounding for 0230 CST, April 2, 1957. The sounding is plotted to the 100-millibar level, and winds are shown to the 400-millibar level. The negative energy area is stippled, and the positive energy area is shaded. Note the low-level temperature inversion and the relatively large size of the negative energy area. Plotted in the cross are the following data: Upper left, base and top of the positive energy area in millibar; upper right, lifted index; lower left, mean mixing ratio of the lower 3,000 feet; lower right, forecast maximum surface temperature in °F. and the forecast mean potential temperature of the lower 3,000 feet in °A.

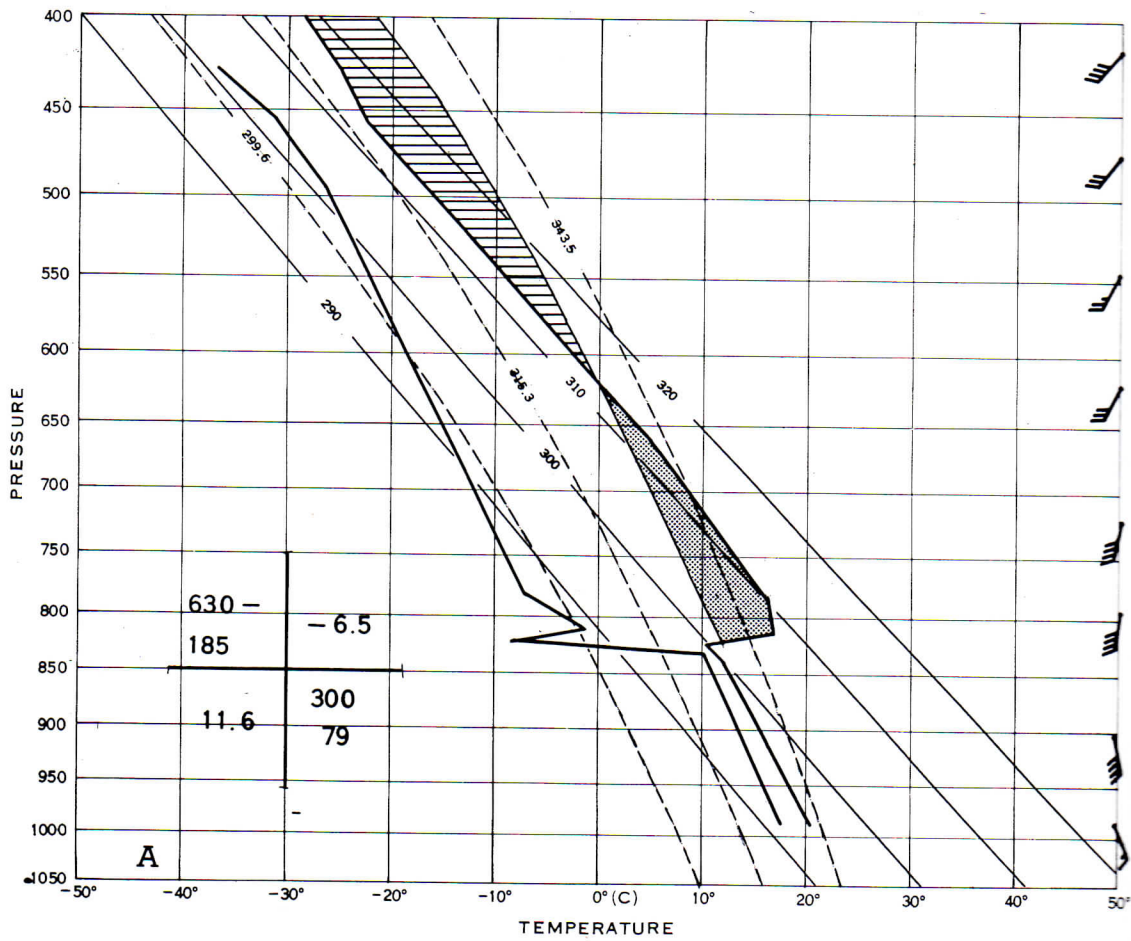
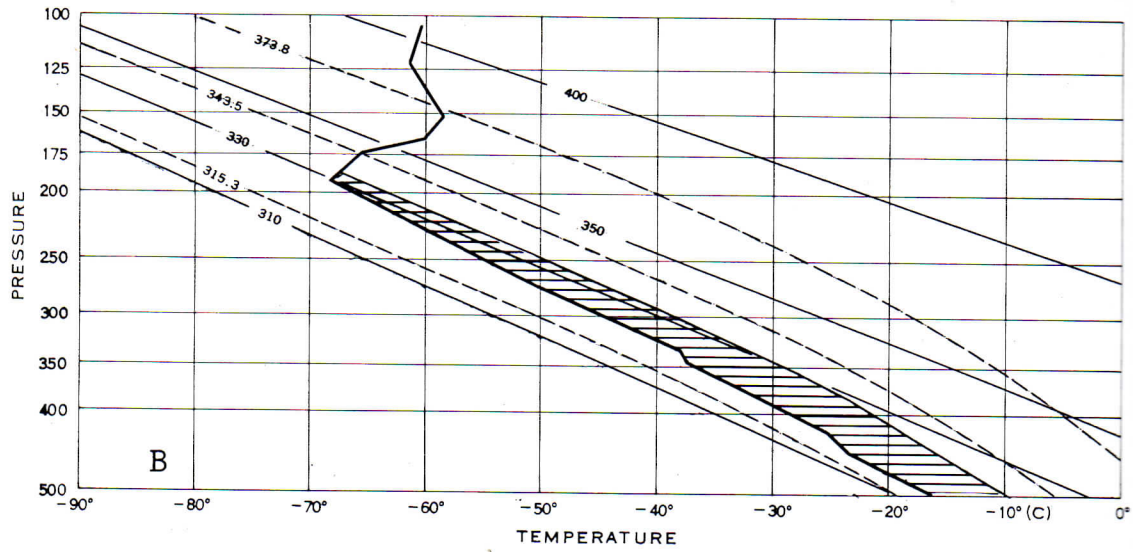

FIGURE 2.—Carswell AFB sounding for 0830 CST, April 2, 1957. The inversion has risen but still constitutes a significant negative energy area. The positive energy area has increased considerably and now extends to the tropopause. Note the increase in low-level moisture over the previous sounding.

FIGURE 3.—Carswell AFB sounding for 0830 CST, April 2, 1957. The inversion has risen but still constitutes a significant negative energy area. Note the increase in low-level moisture over the previous sounding.

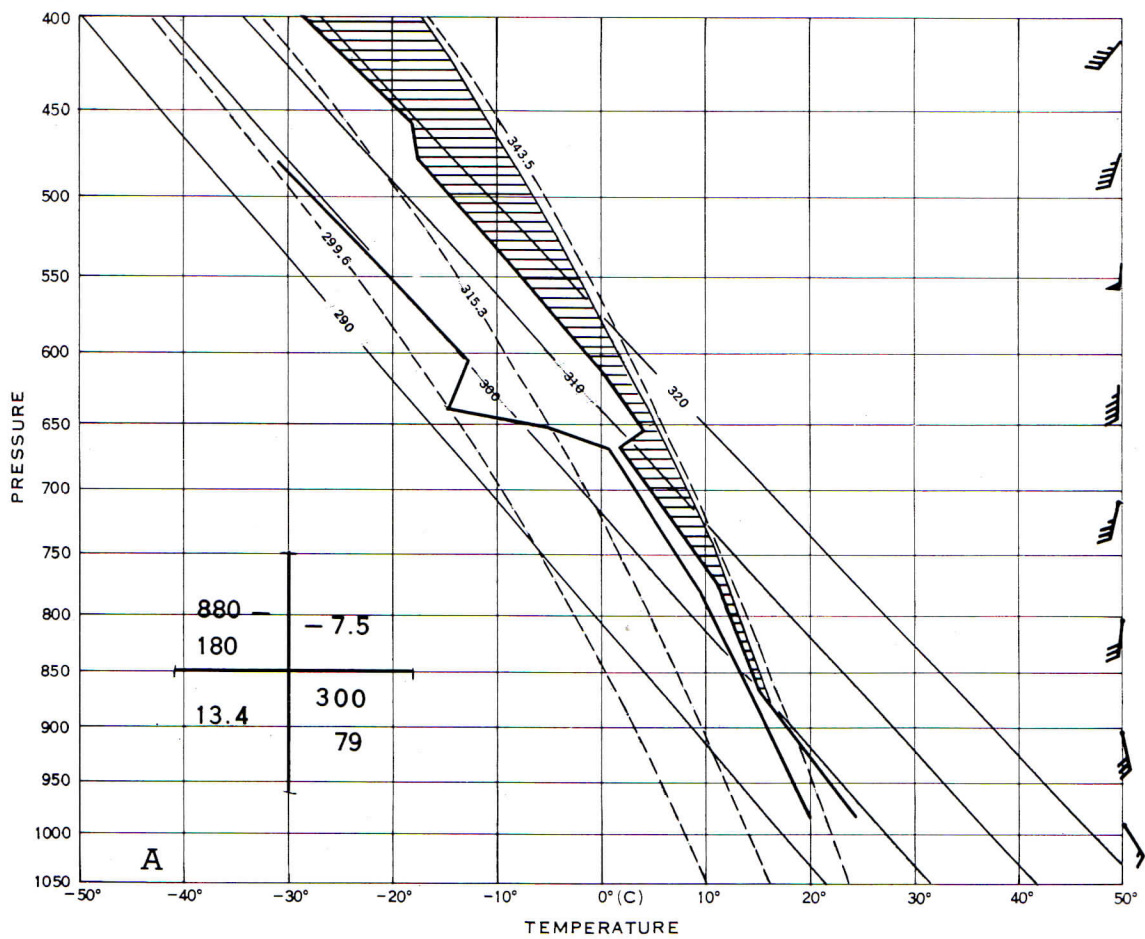
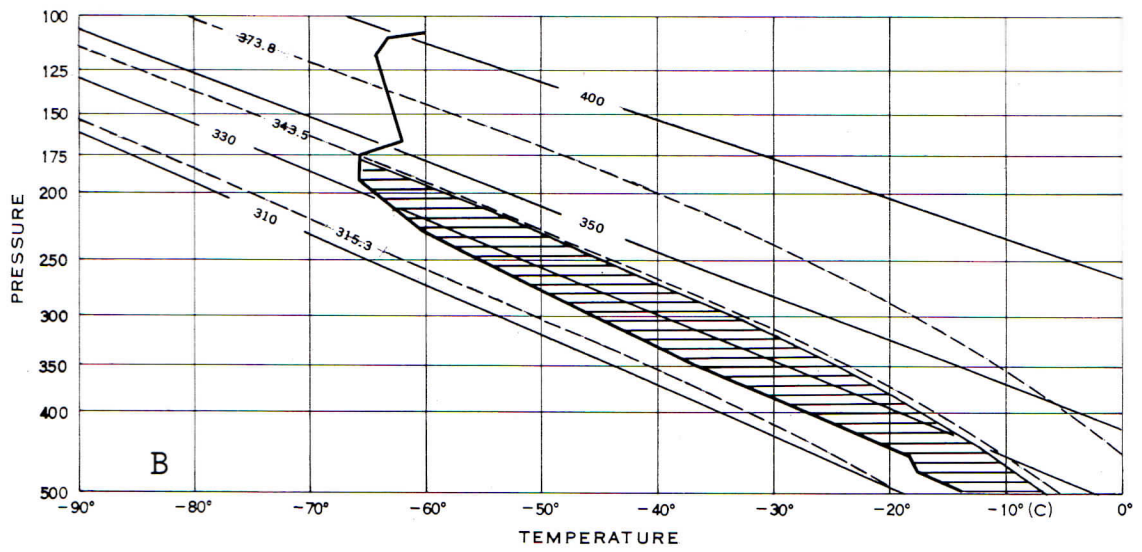

FIGURE 3.—Carswell AFB sounding for 1430 CST, April 2, 1957. The inversion has risen still higher but no longer constitutes a negative energy area. The positive energy area is of considerable size and extends to the tropopause. From buoyancy considerations the air mass should now be releasing its latent instability.

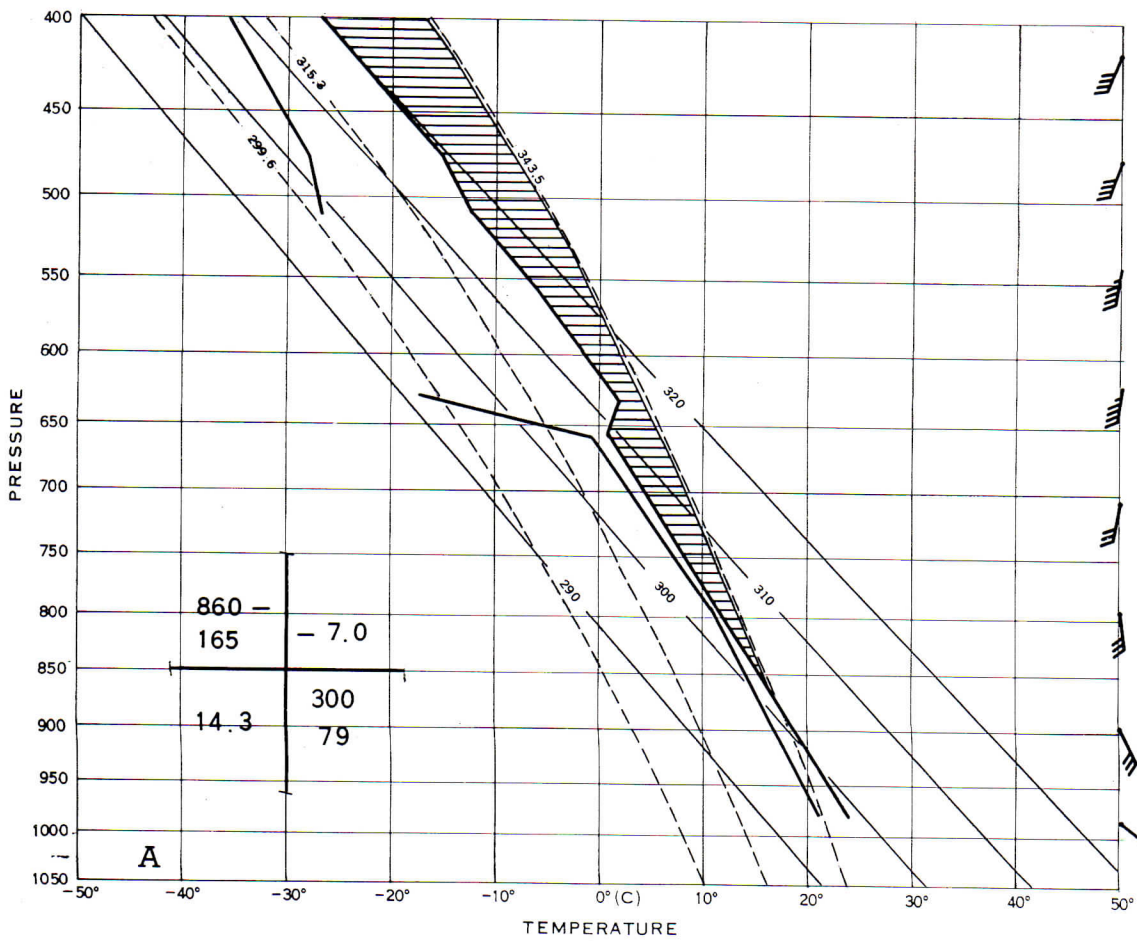
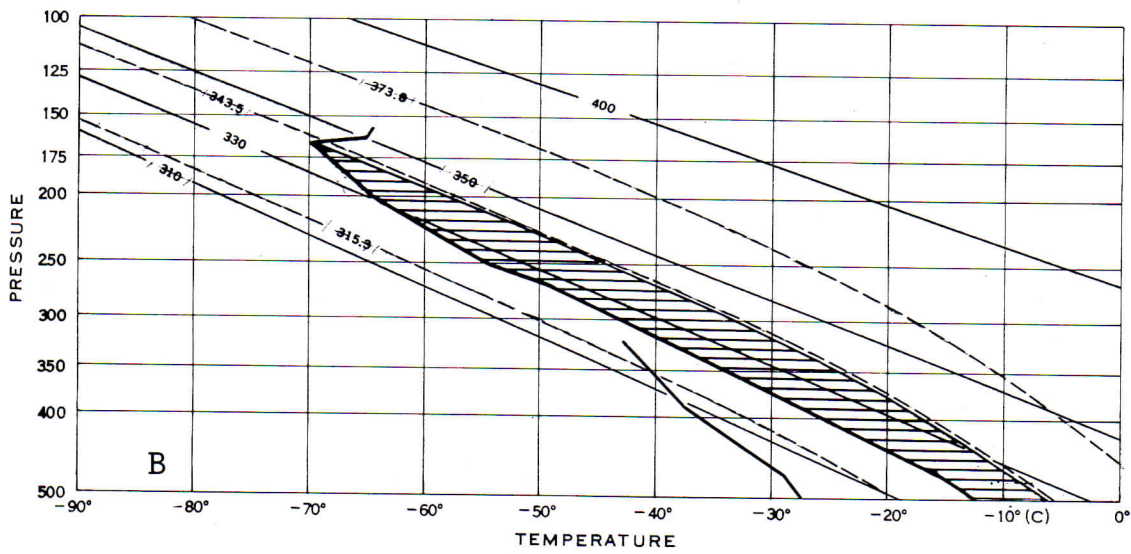

FIGURE 4.—Carswell AFB sounding for 1710 CST April 2, 1957. The inversion has risen slightly but has not been eliminated. A large positive area still remains. For the first time moisture is now present above the 400-millibar level and exists to at least the cutoff point of the radiosonde element.

FIGURE 5.—

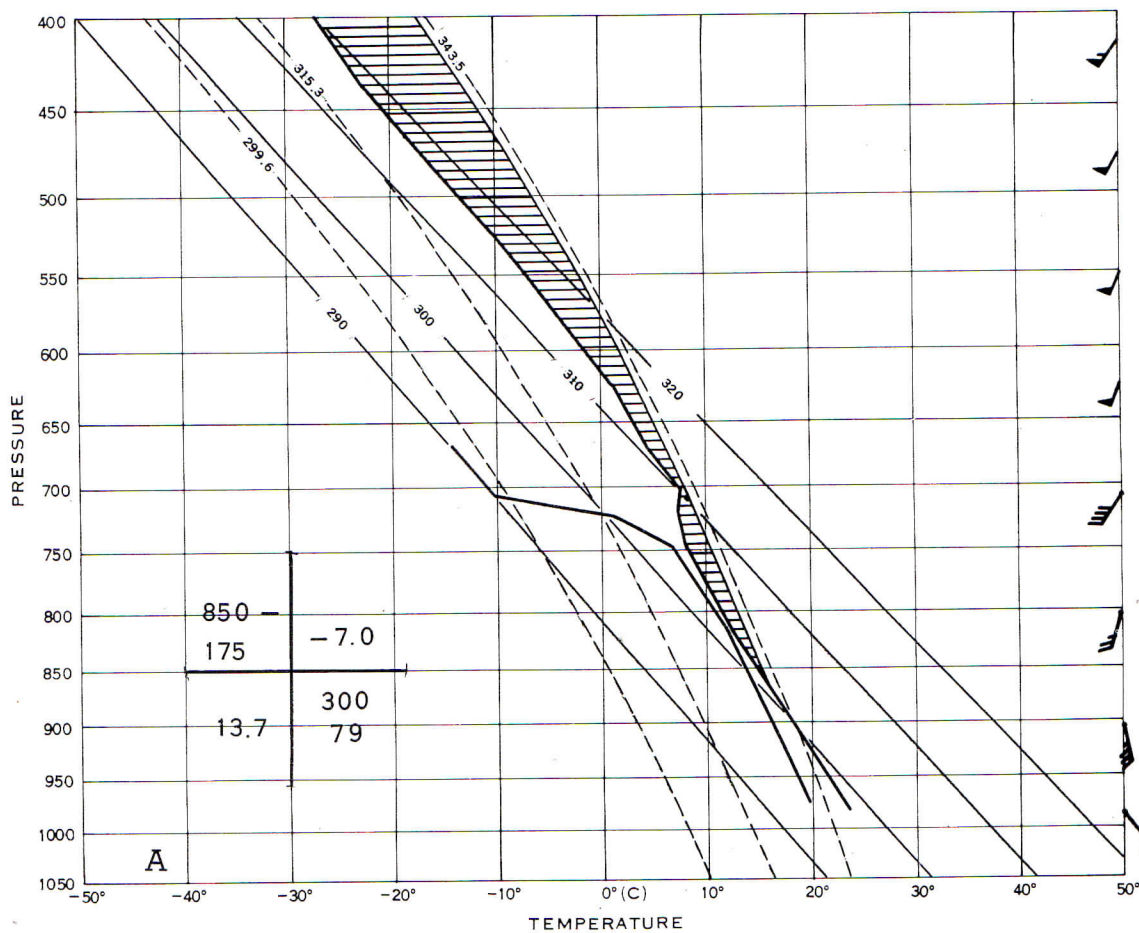
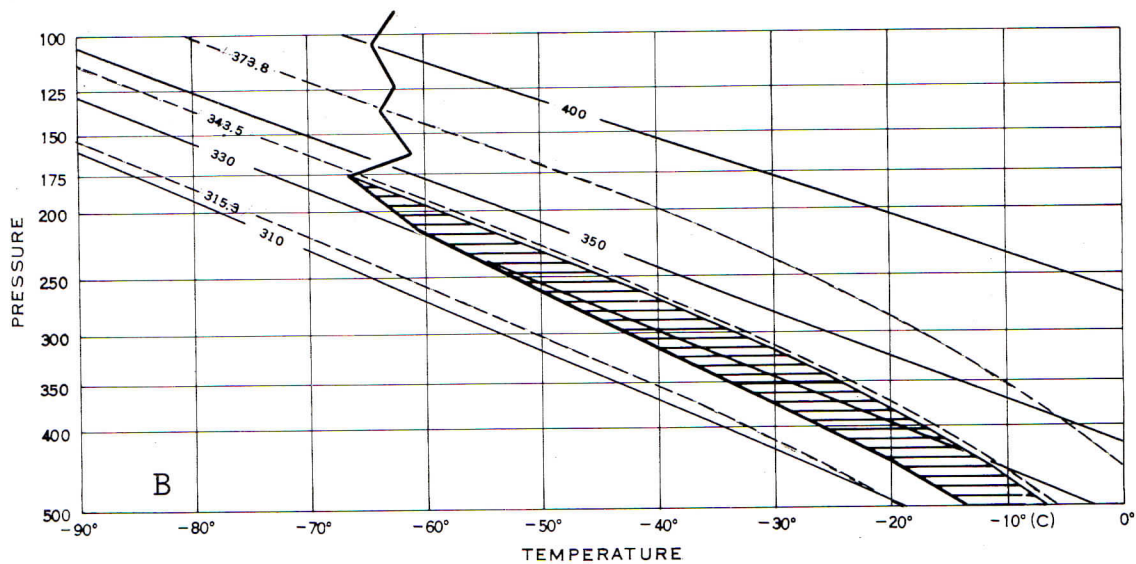

FIGURE 5.—Carswell AFB sounding for 1930 cst April 2, 1957. The inversion has descended and the upper-level moisture has disappeared. A large positive energy area, extending to the tropopause, still exists.

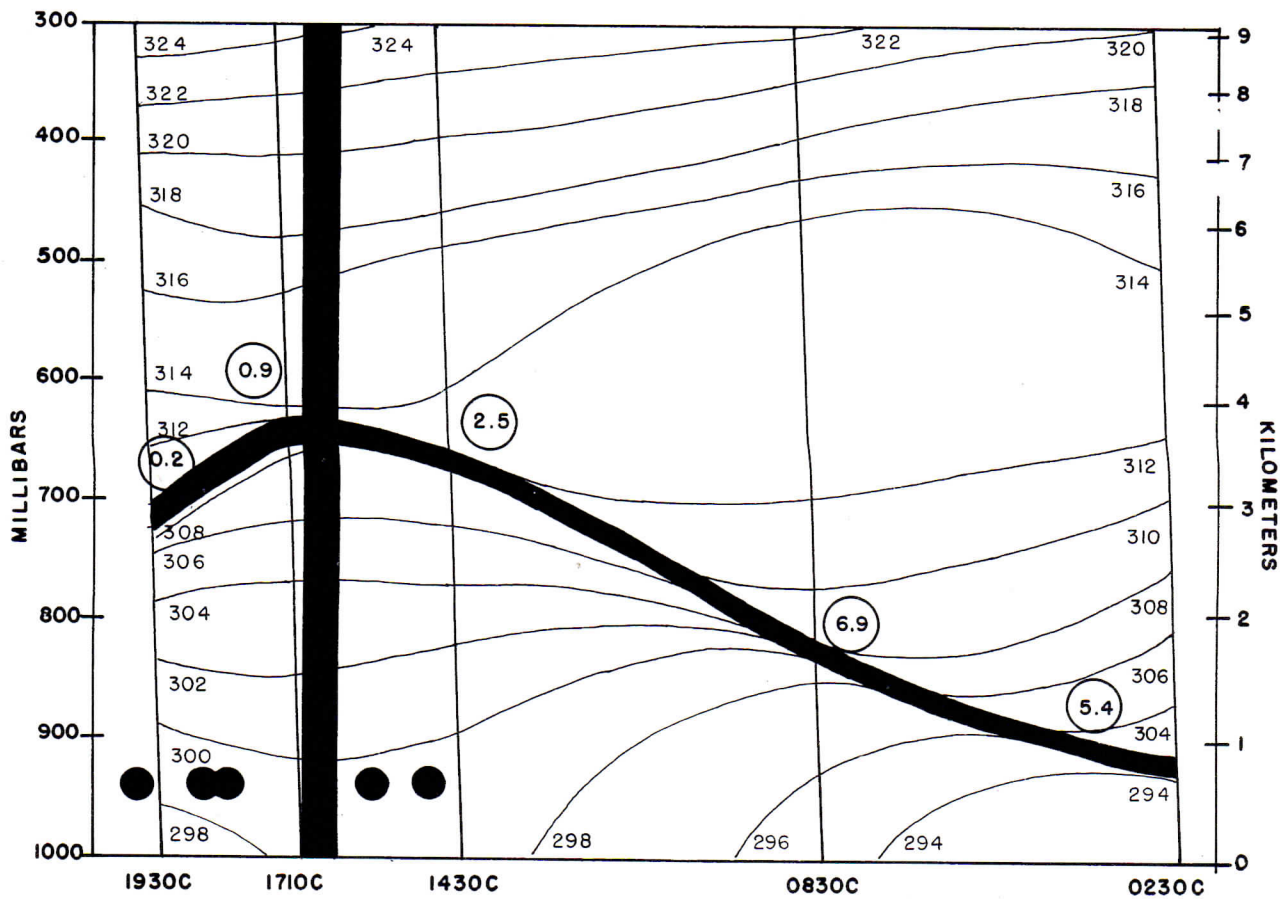

FIGURE 6.—Time cross section of potential temperature. The time of tornado occurrence at Dallas is indicated on this and the other sections by the heavy black column. Times of other tornadoes and funnel clouds are indicated by the large black dots. Isentropes are drawn for each 2° A. and the base and top of the temperature inversion is shown as a heavy solid line. Note the merging of the isentropes into the inversion. Amounts of the temperature inversion are indicated in the circles.

relative humidity at 320 millibars) at 1710 CST suggests that it may have been transported upward by vertical motion. However, since the sounding had a "motorboating" humidity in the layer from 631 to 513 millibars at 1710 CST, it is likely that the vertical transport of moisture occurred at some distance from Carswell, with a subsequent horizontal transport of moisture over the station. This suggests that vertical injections of moisture to great heights did not occur uniformly over the entire area, but occurred rather in isolated columns.

HORIZONTAL ADVECTION OF TEMPERATURE

The advective temperature change was computed from winds aloft data, using Panofsky's

[3] equation of thermal advection. The equation was used, rather than transport of isotherms along streamlines of constant pressure charts, for these reasons: (1) It is applicable to non-synoptic (single station) data, (2) it is more objective, and (3) it provides values for more levels. The equation, which was derived on the assumption of geostrophic flow, is:

$$-\mathbf{V} \cdot \nabla_P T_V = V^2 \frac{\partial \alpha f T_V}{\partial z} g \quad (1)$$

where:

\mathbf{V} = wind vector on a constant pressure surface.

∇_P = vector gradient operator on the constant pressure surface.

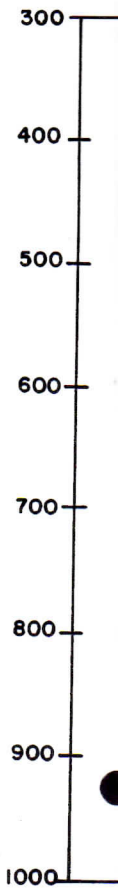

FIGURE 7.—
tion of
the top

T_V
 $-\mathbf{V} \cdot \nabla_P T_V$

V

$\frac{\partial \alpha}{\partial z}$

f
 g

It is now
ture at a c
the virtual
level, and t

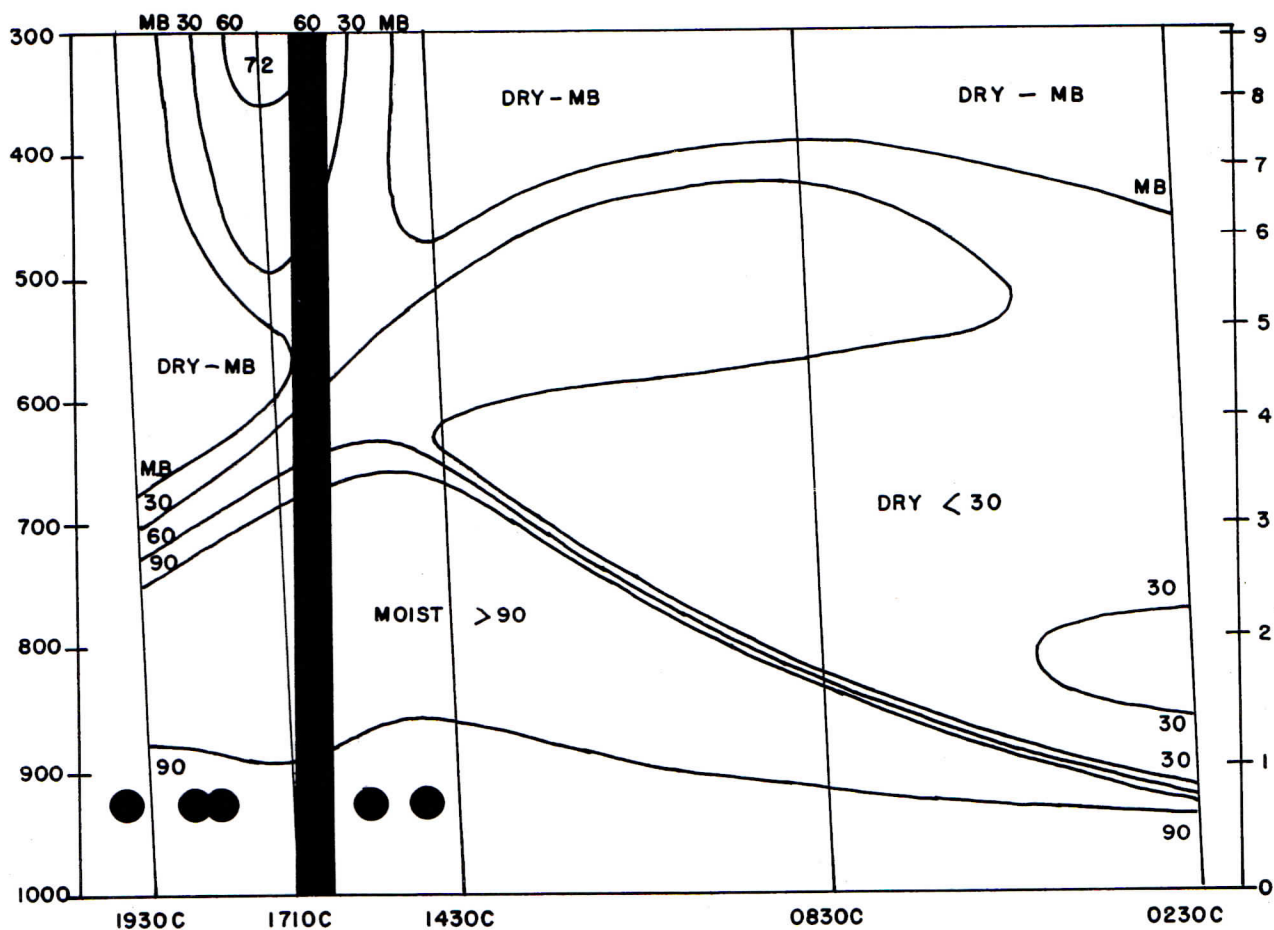

FIGURE 7.—Time cross section of relative humidity. Isoleths are drawn for each 30 percent. The extreme stratification of moisture along the low-level temperature inversion may be noted. Note also the existence of moisture to the top of the section of 1710 CSR.

T_v = virtual temperature of the constant pressure surface.

$-\mathbf{V} \cdot \nabla_P T_v$ = advection of virtual temperature on the constant pressure surface.

V = wind speed on the constant pressure surface.

$\frac{\partial \alpha}{\partial z}$ = change in wind direction α with height z . This was evaluated through a layer which has the constant pressure surface as its midheight.

f = Coriolis parameter.

g = acceleration of gravity.

along a constant height surface, approximates $\nabla_P T_v$, the gradient of virtual temperature along a constant pressure surface, so that:

$$-\mathbf{V} \cdot \nabla_2 T = V^2 \frac{\partial \alpha}{\partial z} \frac{fT}{g} \quad (2)$$

Equation (2) is sensitive to small changes in V and α . To obtain the best possible accuracy, values of V and α were taken to the nearest meter per second and the nearest whole degree for each standard kilometer level. The equation was applied to layers 2 kilometer thick to yield the advection at the midheights of the layers. Layers were overlapped to provide values at each kilometer level. Values of horizontal advection of temperature obtained are shown in table 4. A time cross section of horizontal advection of temperature is shown in figure 8.

It is now assumed that T , the actual temperature at a constant height level, approximates T_v , the virtual temperature at a constant pressure level, and that $\nabla_2 T$, the gradient of temperature

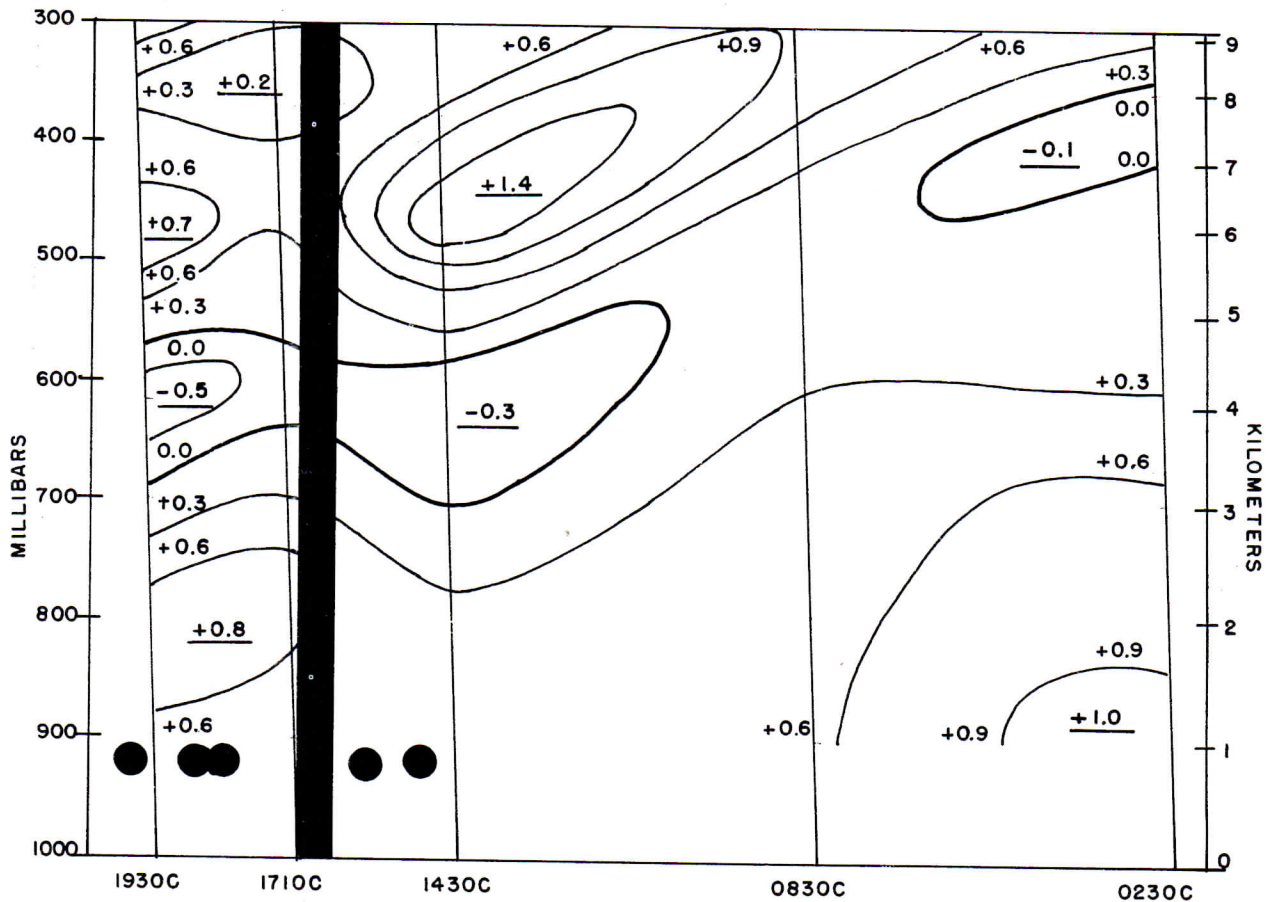

FIGURE 8.—Time cross section of horizontal temperature advection. Isoleths are drawn for each 0.3° C. per hour. Note the warm advection at low levels, the cold advection at intermediate levels, and the warm advection at upper levels.

Warm advection in the lower levels was surmounted by a nearly continuous layer of cold advection and this layer was in turn surmounted by a layer of warm advection. Although the rates of advection were rather small, it may be noted that the advection pattern tended to de-

TABLE 4.—Horizontal advection of temperature. Values are in degrees Celsius per hour

Level (kilometers)	0230 CST	0830 CST	1430 CST	1710 CST	1930 CST
1	0.97	0.55	0.36	0.43	0.57
2	.76	.44	.40	.63	.78
3	.68	.43	-.03	.30	.17
4	.37	.32	-.26	-.09	-.46
5	.09	.19	.47	.25	.28
6	.18	.15	1.37	.30	.72
7	-.02	.35	1.05	.30	.42
8	-.14	.73	.45	.21	.25
9	.35	.88	.38	.29	.77
10	.50	1.00	.06	.68	1.05

crease the stability from the surface to near the top of the cold advection layer.

One purpose in computing the horizontal advection of temperature was for subsequent use in determining vertical velocity by the adiabatic method. For this purpose it is necessary to know

TABLE 5.—Mean horizontal advection of temperature. Values are in degrees Celsius per hour

Level (kilometers)	0230-0830 CST	0830-1430 CST	1430-1710 CST	1710-1930 CST
1	0.76	0.46	0.40	0.50
2	.60	.42	.52	.71
3	.56	.20	.14	.24
4	.35	.03	-.18	-.27
5	.14	.33	.36	.27
6	.17	.76	.84	.51
7	.17	.70	.68	.36
8	.30	.59	.33	.23
9	.62	.63	.34	.53
10	.75	.53	.37	.87

the mea
between
vection
tain the
sounding
this ave
values f
In the
desirable
for each
necessar
tion from
This wa
of the ad
ing off th
procedur
sively in
so obtain

Mean
adiabatic

where:

$$-\mathbf{V} \cdot \nabla_2$$

TABLE 6.—
V

Level (millibars)	Value
900
850
800
750
700
650
600
550
500
450
400
350
300
250

the mean advective rate for the periods of time between soundings. The equation of thermal advection yields only instantaneous values. To obtain the mean rate, values for each two successive soundings were averaged, it being assumed that this average approximated the mean rate. Mean values for the periods are shown in table 5.

In the computation of vertical velocity it was desirable to compute the mean vertical velocity for each 50-millibar level. To do this it was then necessary to convert the mean horizontal advection from 1-kilometer levels to 50-millibar levels. This was accomplished by constructing profiles of the advection with respect to height and reading off the values for each 50-millibar level. This procedure smooths the profile some, but not excessively in this case. Values of the mean advection so obtained are shown in table 6.

MEAN VERTICAL MOTION

Mean vertical motion was computed by the adiabatic equation (cf. [3]):

$$w = -\frac{\frac{\partial T}{\partial t} + \mathbf{V} \cdot \nabla_2 T}{(\Gamma - \gamma)} \quad (3)$$

where:

w = mean vertical motion.

$\frac{\partial T}{\partial t}$ = local change in temperature with respect to time.

$-\mathbf{V} \cdot \nabla_2 T$ = horizontal advection of temperature.

Γ = adiabatic lapse rate (dry, moist, or combination of both as appropriate).

γ = existing lapse rate.

TABLE 6.—Mean horizontal advection of temperature. Values are in degrees Celsius per hour

Level (millibars)	0230-0830 CST	0830-1430 CST	1430-1710 CST	1710-1930 CST
900	0.76	0.46	0.40	0.50
850	.68	.44	.46	.60
800	.60	.42	.52	.71
750	.58	.31	.33	.48
700	.56	.20	.14	.24
650	.43	.10	-.04	-.06
600	.30	.09	-.08	-.17
550	.17	.29	.30	.18
500	.16	.57	.62	.40
450	.17	.73	.78	.46
400	.19	.68	.65	.33
350	.32	.60	.38	.28
300	.63	.62	.35	.60
250	.25	.32	.36	.66

Because the diabatic change in heat of the parcel generally cannot be measured, it has been neglected in equation (3). Thus, the equation must be applied only to those levels at which the change in heat can be assumed to be negligibly small. Greatest changes in heat usually occur at low levels due to insolation and radiation. In the case presented the effects of these changes were minimized by making computations only at 800 millibars and above. Changes in heat due to change of state of water can be accounted for by the selection of the proper adiabatic rate (dry, moist, or combination of both). However, as pointed out in the next paragraph, such changes in heat were also neglected at the few levels where they might have occurred.

The lapse rate difference, $(\Gamma - \gamma)$, was measured from the plotted soundings in degrees Celsius per kilometer for each 50-millibar level from 800 to 250 millibars. Γ was taken as the dry adiabatic rate in all cases; i.e., it was assumed that the parcels remained unsaturated during ascent or descent. This assumption was warranted in all cases except the following: 800-, 750-, and 700-millibar levels at 1430, 1710, and 1930 cst, when the near saturation of the stratum made the use of the dry adiabatic rate questionable. An attempt was made to use a combination of dry and moist rates for the moist stratum, but vertical velocities obtained appeared unreasonable. Consequently the values computed at the dry adiabatic rate were retained, even though questionable. Fortunately the subsidence layer to be discussed presently lies above the few levels at which $(\Gamma - \gamma)$ and vertical velocity might be questionable. Values of $(\Gamma - \gamma)$ are shown in table 7.

Since all of the components of equation (3) are

TABLE 7.—Lapse rate difference. Values are in degrees Celsius per kilometer. Questionable values are enclosed by parentheses

Level (millibars)	0230 CST	0830 CST	1430 CST	1710 CST	1930 CST
800	3.5	11.5	(4.5)	(3.0)	(3.0)
750	3.5	2.5	(3.1)	(3.5)	(6.0)
700	2.0	1.2	(6.0)	(3.0)	(5.5)
650	1.2	.7	5.6	5.5	3.0
600	1.2	.6	1.0	3.0	2.0
550	1.0	.6	1.2	1.6	.8
500	1.0	.4	1.4	1.6	1.5
450	1.0	2.6	2.0	2.0	1.6
400	1.5	1.0	1.0	1.5	1.5
350	1.0	3.0	1.5	1.5	1.5
300	1.0	1.0	1.0	1.0	2.0
250	2.5	1.5	2.0	1.0	1.5

TABLE 8.—Mean lapse rate difference. Values are in degrees Celsius per kilometer. Questionable values are enclosed by parentheses

Level (millibars)	0230-0830 CST	0830-1430 CST	1430-1710 CST	1710-1930 CST
800	7.5	(8.0)	(3.7)	(3.0)
750	3.0	(2.8)	(3.3)	(4.8)
700	1.6	(3.6)	(4.5)	(4.3)
650	1.0	3.2	5.5	4.3
600	.9	.8	2.0	2.5
550	.8	.9	1.4	1.2
500	1.3	1.5	1.5	1.5
450	1.8	2.3	2.0	1.8
400	1.3	1.0	1.3	1.5
350	2.0	2.2	1.5	1.5
300	1.0	1.0	1.0	1.5
250	2.0	2.8	1.5	1.2

mean values for a period of time, the lapse rate difference should also be a mean. This mean was approximated by averaging the values, level for level, for each two consecutive soundings. The mean values of $(\Gamma - \gamma)$ are shown in table 8.

TABLE 9.—Mean vertical velocity. Values are in centimeters per second. Questionable values are enclosed by parentheses

Level (millibars)	0230-0830 CST	0830-1430 CST	1430-1710 CST	1710-1930 CST
800	0.9	(4.3)	(4.2)	(6.6)
750	2.3	(11.3)	(4.4)	(2.8)
700	6.3	(5.8)	(.9)	(-6.3)
650	8.6	.7	4.3	(-6.6)
600	7.7	-2.1	-1.7	-2.8
550	5.9	2.8	-1.4	6.3
500	5.6	5.9	1.1	12.2
450	3.6	2.2	9.3	15.9
400	-2	12.5	10.7	9.3
350	2.1	5.4	-1.1	6.9
300	8.3	18.1	-8.9	11.3
250	-1.0	4.9	-3.7	-7.9

Substituting values from tables 3, 6, and 8 into equation (3) yields the mean vertical velocity shown in table 9 and figure 9. Questionable values are indicated by parentheses in the table and by dashed isotachs in the figure. In the fig-

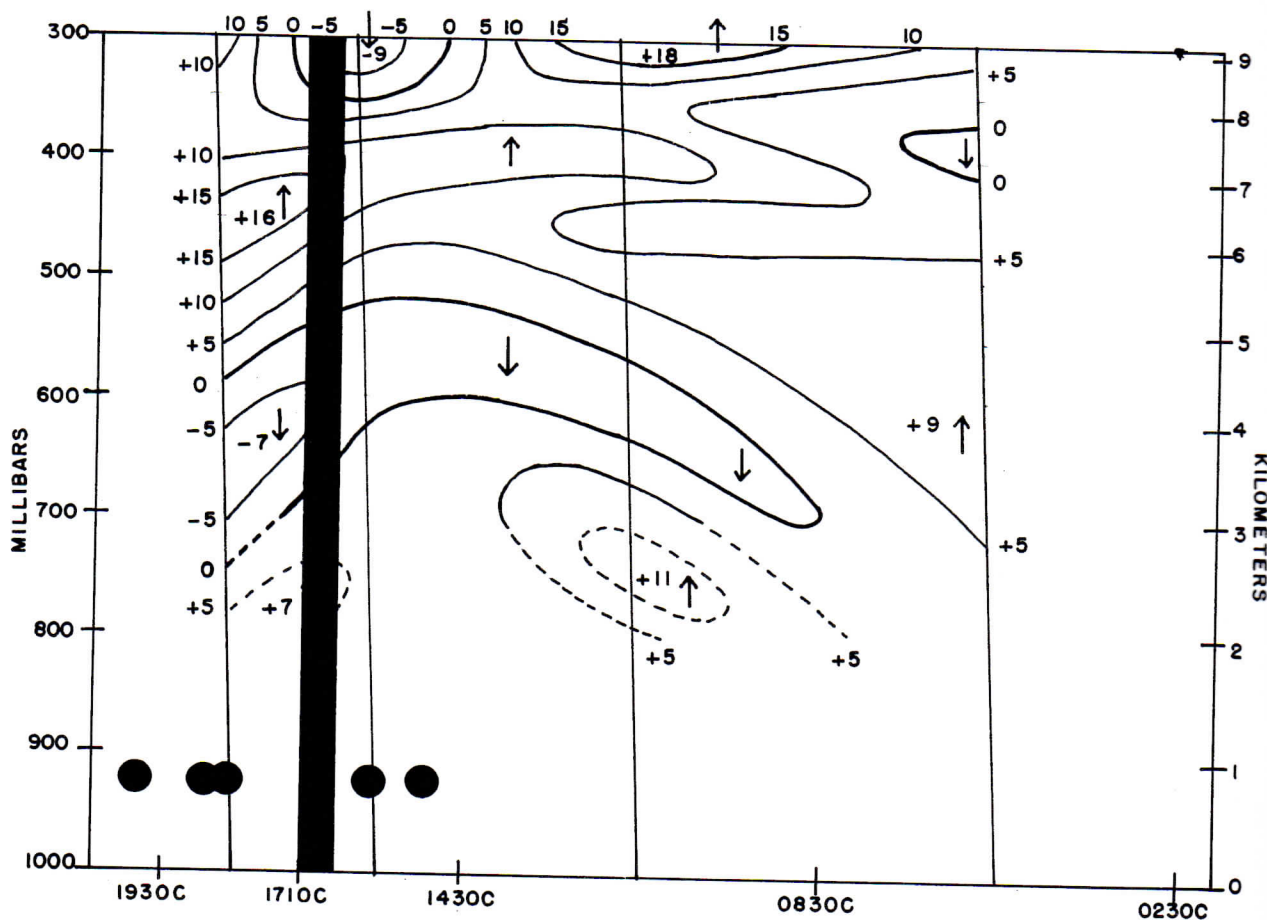

FIGURE 9.—Time cross section of mean vertical motion. Isotachs are drawn for each 5 cm. sec.⁻¹. Note the upward motion at low and upper levels and the subsidence motion at intermediate levels. Near the 300-millibar level there is upward motion of 18 cm. sec.⁻¹ between 0830 and 1430 cst, while between 1430 and 1710 cst there is downward motion of 9 cm. sec.⁻¹ at this level.

TABLE 10.—Time period of inv...

Time period (CST)
0230-0830
0830-1430
1430-1710
1710-1930

ure mea
tween th
the mean
It shoul
the valu
periods
values o
(and un
mean.
Signif

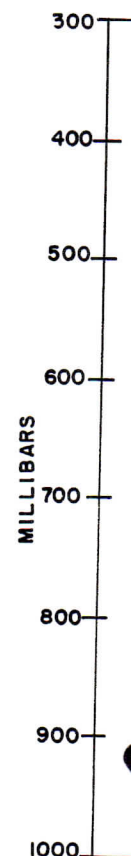
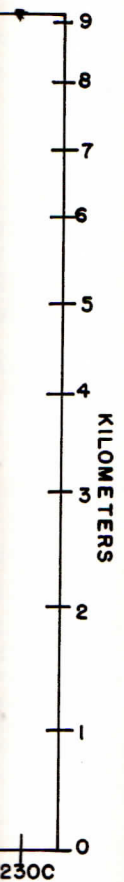

FIGURE 10.

re in centi-
enclosed by

Time period (CST)	Mean vertical velocity (cm/sec)
1710-1930	(6.6)
0230-0830	(2.8)
0830-1430	(-6.3)
1430-1710	-6.6
1710-1930	-2.8
	6.3
	12.2
	15.9
	9.3
	6.9
	11.3
	-7.9

and 8 into
l velocity
questionable
the table
n the fig-



Note the
00-millibar
CST there

TABLE 10.—Mean vertical velocity computed by displacement of inversion surface as compared to the adiabatic method

Time period (CST)	Lifting of inversion surface	Adiabatic method
0230-0830	4.3 cm./sec. from 926-825 mb....	Not computed below 800 mb.
0830-1430	7.6 cm./sec. from 825-670 mb....	7.1 cm./sec. from 800-700 mb.
1430-1710	1.8 cm./sec. from 670-657 mb....	2.6 cm./sec. from 700-650 mb.
1710-1930	-8.9 cm./sec. from 657-724 mb....	-6.4 cm./sec. from 650-700 mb.

ure mean values have been plotted midway between the observation times, it being assumed that the mean value approximates the midperiod value. It should be stressed at this point, however, that the values shown are means for the considerable periods of time between soundings. Instantaneous values of vertical velocity at any given time could (and undoubtedly did) deviate greatly from the mean.

Significant features of the mean vertical mo-

tion are upward motion at low levels, a subsidence layer at intermediate levels, and general upward motion immediately above the subsidence layer. This subsidence layer is believed to be of particular importance in the occurrence of the tornadoes.

In section 3 on temperature it was indicated that the inversion surface could have been lifted by vertical motion. The vertical velocities required to do this, computed from the distance the inversion surface was displaced and the length of time required for the displacement, are shown in table 10. Values obtained for approximately the same layers by the adiabatic equation are also shown. Fair agreement exists between the two methods.

WIND DIRECTION

A time cross section of wind direction is shown in figure 10. Values of wind direction and speed

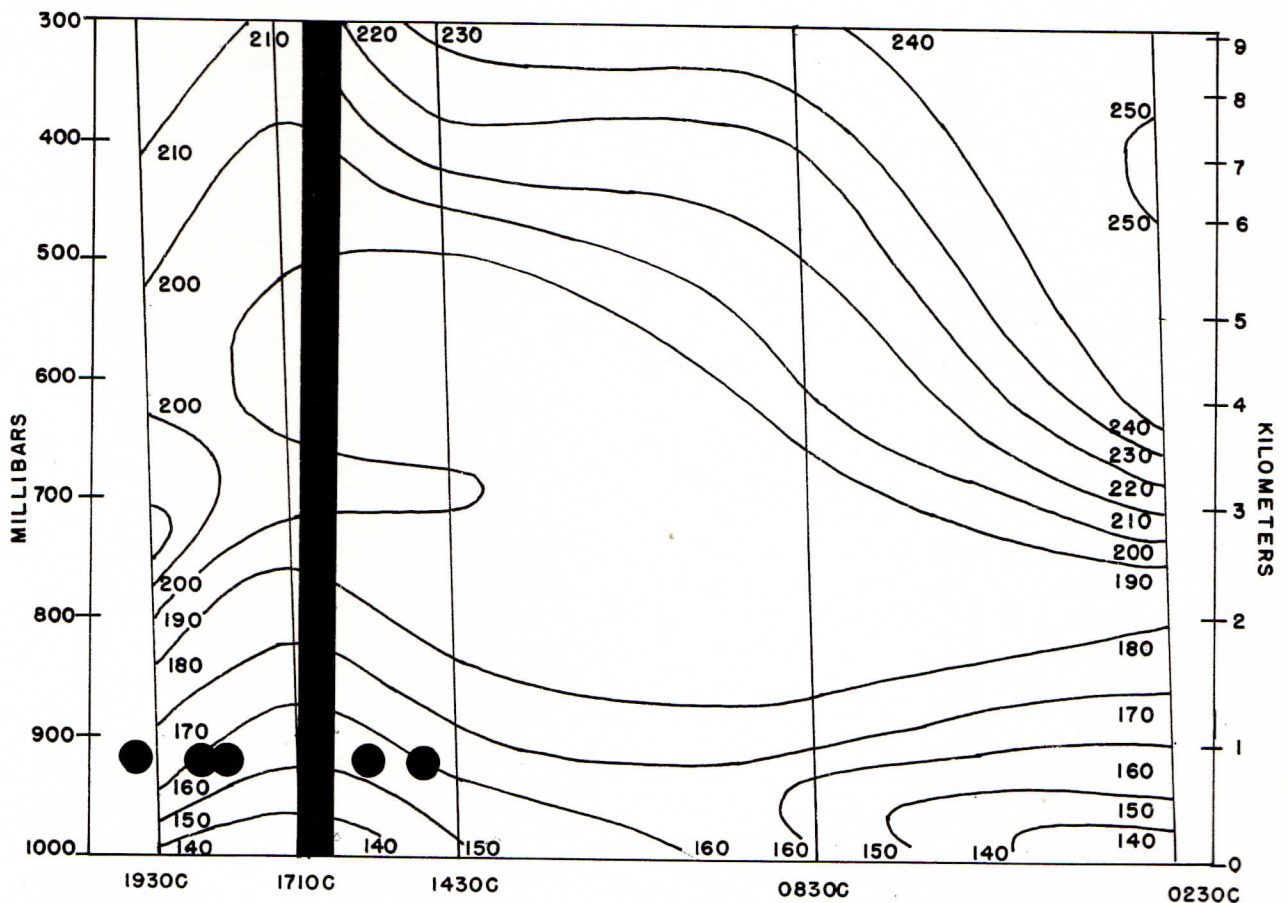

FIGURE 10.—Time cross section of wind direction. Isogons are drawn for each 10°. Note the backing of the wind with time prior to 1710 cst and the veering thereafter.

TABLE 11.—Winds aloft for standard kilometer levels. Direction given to the nearest whole degree, and speed to the nearest whole meter per second

Level (kilometers)	0230 CST	0830 CST	1430 CST	1710 CST	1930 CST
Surface.....	130-08	160-08	150-08	130-04	140-05
0.5.....	151-16	153-13	152-13	145-10	159-12
1.0.....	162-22	171-20	170-14	156-15	169-17
1.5.....	173-21	184-21	179-17	164-16	177-16
2.0.....	181-15	186-21	183-15	173-16	192-12
2.5.....	189-11	182-19	187-16	181-16	210-15
3.0.....	213-11	186-19	191-18	191-15	208-21
4.0.....	243-13	203-15	182-22	186-22	198-26
5.0.....	244-15	204-13	183-24	188-24	198-27
6.0.....	249-15	215-16	194-23	193-20	203-27
7.0.....	255-16	212-19	218-22	196-21	210-29
8.0.....	248-21	231-22	226-23	208-13	211-28
9.0.....	250-27	237-24	232-23	206-21	215-26
10.0.....	257-28	253-33	236-29	222-21	228-28

are shown in table 11. With some exceptions there was a general backing of the wind with time at most levels prior to 1710 CST. The exceptions were surface to 2.0 kilometers, 0230-0830 CST; 2.5 to 3.0, and 7.0 kilometers, 0830-1430 CST; and 3.0 and 5.0 kilometers, 1430-1710 CST. Wind veered with time at all levels after 1710 CST. This veering indicates that a wind shift line, extending

to great heights, passed the station at the approximate time of the Dallas tornado. Unfortunately the time intervals between soundings are too great (over 2 hours) to permit locating the wind shift line exactly in time, or to permit the showing of any possible discontinuity in the shift.

WIND SPEED

A time cross section of wind speed is shown in figure 11, and speeds are tabulated in table 11. The existence of a low-level jet at 0230 and 0830 CST may be noted. A wind speed minimum of 13 meters per second at the 8-kilometer level occurred with the 1710 CST sounding, followed by increasing speed thereafter. This indicates an upper-level change in wind speed as well as wind direction at the approximate time of the Dallas tornado.

The possible effect of a jet stream has not been investigated. The sections do not extend high enough to show winds at the jet stream level.

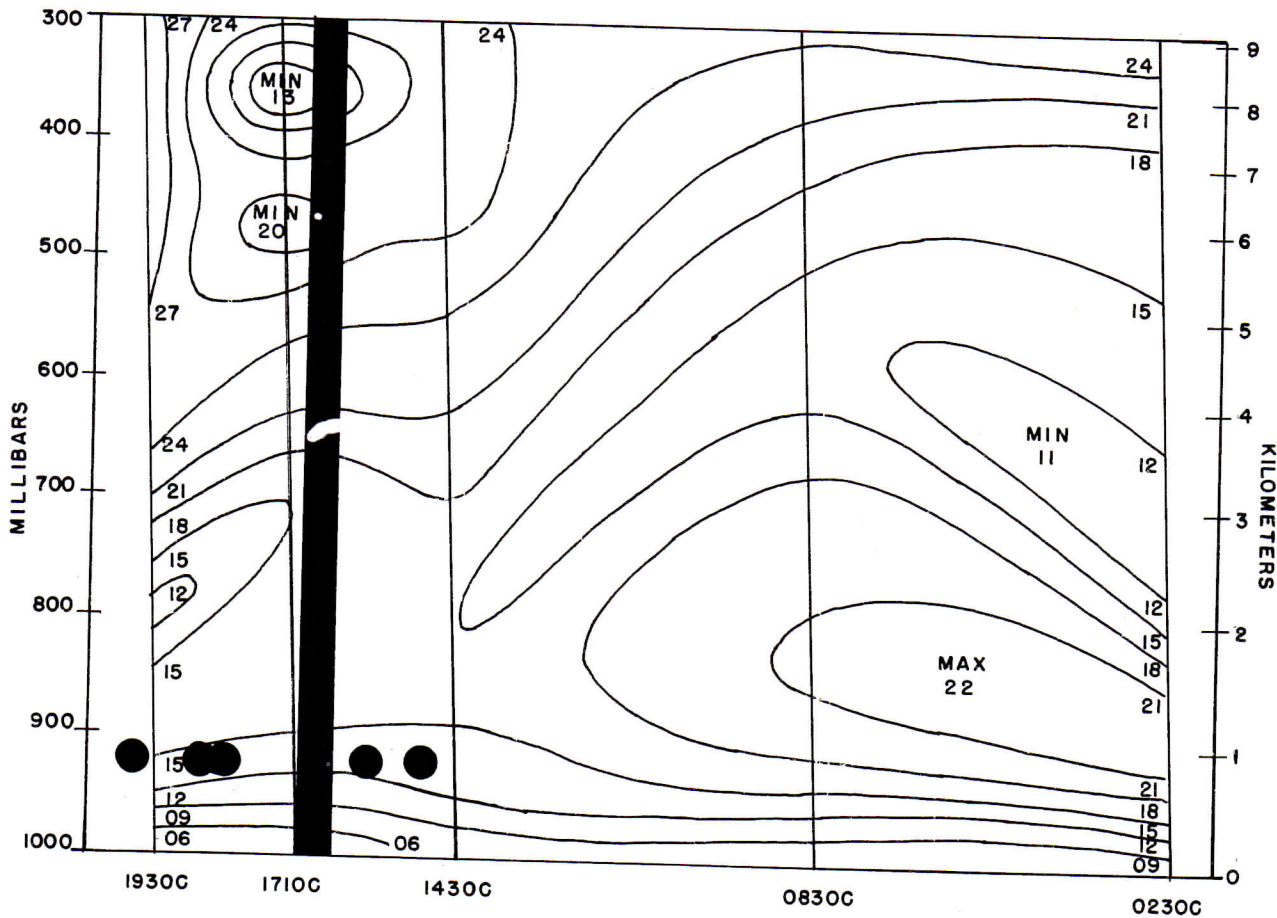

FIGURE 11.—Time cross section of wind speed. Isotachs are drawn for each 3 m. sec.⁻¹. Note the low-level maximum from 0230 to 0830 CST and the upper-level minimum at 1710 CST.

Surf
forms
Dallas
Carsw
conditi
are giv
Love
and str
ing the
very li
with h
Thund
with 1/2
first cu
CST and
Amon
stratus
ent dur
showers
intensit
The mo
to 1526

During
low-level
bility to
However
3a) the
provided
stability
early aft
at this t
in the su
ably assi
hours, a
Since
buoyanc
forces of
subsiden
dynamic
horizontal
of diverg
sidence.
pute the
accuracy
The ex
sidence l
which co
develop a
would "le

3. SURFACE CONDITIONS

Surface weather conditions were obtained from forms WBAN 10A and 1130B for Love Field, Dallas; Amon Carter Field, Fort Worth; and Carswell AFB, Fort Worth. Significant surface conditions (excepting tornadoes) at these stations are given below.

Love Field: General broken to overcast stratus and stratocumulus-type clouds were present during the morning hours. There were intermittent very light rain showers from 1136 to 1715 cstr with heavy rain showers from 1645 to 1650 cstr. Thunderstorms occurred from 1612 to 1722 cstr with $\frac{1}{8}$ -inch hail from 1645 to 1649 cstr. The first cumulus-type cloud was reported at 1426 cstr and the first cumulonimbus cloud at 1526 cstr.

Amon Carter Field: General broken to overcast stratus and stratocumulus-type clouds were present during the morning hours. Intermittent rain showers occurred from 1153 to 1650 cstr with the intensity varying from very light to moderate. The moderate rain showers occurred from 1523 to 1526 cstr, and thunderstorms occurred from

1654 to 1716 cstr. The first towering cumulus cloud was reported at 1326 cstr, and the only cumulonimbus cloud reported was at 1927 cstr.

Carswell AFB: General broken to overcast stratus and stratocumulus-type clouds were present during the morning hours. Intermittent rain and rain showers occurred from 1138 to 1841 cstr with the intensity varying from light to very light. Thunderstorms occurred from 1749 to 1841 cstr. The first towering cumulus was reported at 1129 cstr, and the first cumulonimbus was reported at 1612 cstr.

The following features were generally common to all of the stations: (1) Broken to overcast stratus and stratocumulus-type clouds during the morning hours, (2) intermittent rain showers (mostly very light) from just before noon to late afternoon and early evening, (3) cumulus-type clouds beginning just before noon or in the early afternoon, and (4) cumulonimbus-type clouds beginning just after midafternoon.

4. THE ROLE OF THE SUBSIDENCE LAYER

During the morning hours the existence of the low-level temperature inversion permitted instability to increase, while preventing its release. However, by 1430 cstr, or a little earlier (see fig. 3a) the low-level temperature inversion no longer provided a restraint to rising parcels; thus instability should have been released during the early afternoon. The fact that it was not released at this time is attributed to the downward motion in the subsidence layer. In fact, subsidence probably assisted in the restraint during the morning hours, also.

Since the subsidence would be opposed by the buoyancy of the unstable air, it is reasoned that forces other than buoyancy were the cause of the subsidence. It is suggested that the layer was dynamically driven by a certain pattern of the horizontal wind, which determined a distribution of divergence with height favorable to the subsidence. Unfortunately it is not possible to compute the divergence in this case with sufficient accuracy to substantiate this suggestion.

The existence of such dynamically driven subsidence layers is believed to be the only way in which conditions of extreme latent instability can develop and be maintained. Otherwise instability would "leak off" as fast as it developed.

The possibility of the subsidence layer being penetrated would be determined by the depth and the velocity of the subsidence and the approach of any condition that might reverse the vertical motion. Mean values of the subsidence were weak for the period 1430 to 1710 cstr with a maximum value of only $-1.7 \text{ cm. sec.}^{-1}$ at 600 millibars. The layer was somewhat more than 50 millibars thick during this period. Only a slight change in the vertical velocity would be required to eliminate the subsidence, at least locally and briefly. Small changes in the horizontal wind could have accomplished this, and it may be noted that a significant change did occur. Specifically, the wind shift line, extending to great heights, which passed Carswell AFB during the late afternoon, is believed to have been the mechanism that provided for the penetration of the subsidence layer, which resulted in the Dallas tornadoes. Some of the other tornadoes (e.g., McKinney at 1555-1559 cstr and Azle at 1845 cstr) cannot be related to this wind shift line. However, in these cases it is quite possible that small-scale changes in the wind, temperature, or both, which were too localized in time and space to affect the Carswell AFB sounding, provided for local penetrations of the subsidence layer.

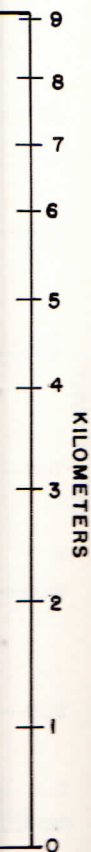

The hypothesized penetrations of the subsidence layer are not reflected in the computed values of vertical motion. This does not invalidate the hypothesis, since the computed values are means for considerable periods of time, and could not be expected to show brief and local changes in the vertical motion.

Although brief and local penetrations of the subsidence layer might result in violent releases of the instability, as characterized by the Dallas

tornadoes, these releases would be too brief and too local to make much change in the overall stability of the general area. Since the subsidence layer continued in the mean sense (and even intensified) to at least 1930 csr, and since latent instability remained great (-7.0 at 1930 csr), it is reasoned that in spite of the tornadoes there still was no general release of the instability that was available.

5. SUMMARY

1. Stability decreased rapidly from 0.0 at 0230 csr to -6.5 at 0830 csr. Lifted indices of -6.5 to -7.5 prevailed from 0830 to 1930 csr.

2. The decrease in stability was accomplished primarily by an increase in low-level moisture, although differential advection of temperature tended to decrease stability also.

3. Positive energy areas on the sounding charts were large from 0830 to 1930 csr with the tops of the areas extending to the tropopause.

4. The rapid decrease in stability and the availability of positive energy to a great height provided a thermodynamic potential for severe thunderstorm activity as early as 0830 csr.

5. A low-level temperature inversion existed throughout the period. Although it was present on all of the soundings (it may have been eliminated briefly between sounding times), it produced a negative energy area on the sounding charts for only the morning hours.

6. An extreme stratification of moisture prevailed at low levels, except in the late afternoon when some penetration to higher levels occurred.

7. The low-level temperature inversion and the top of the moist layer rose from 0230 to 1710 csr and descended thereafter.

8. A mean subsidence layer prevailed at inter-

mediate levels from about 0830 csr to the end of the period.

9. Limited convective activity, in the form of towering cumulus and very light rain showers, began over the area shortly before noon.

10. Severe convective activity, in the form of tornadoes and funnel clouds, occurred over the area from 1508 to 1951 csr.

11. A wind shift line, characterized by a veering of direction with time at all levels up to 300 millibars, and a wind speed minimum at high levels, passed the station during the late afternoon.

12. The subsidence layer is believed to have permitted the latent instability to increase, while preventing its early release.

13. Sudden and violent release of some of the instability in the form of tornadoes is believed to have occurred when the mean subsidence layer was briefly and locally penetrated.

14. The passage of the wind shift line is believed to have been a primary mechanism in effecting local penetrations of the subsidence layer.

15. In spite of the tornadoes there was no general release of the latent instability. The lifted index at 1930 csr was nearly as great as at any other time during the day.

ACKNOWLEDGMENTS

The author deeply appreciates the interest and encouragement given by Messrs. C. F. Van Thullenar and D. C. House in the preparation of this

paper. The author is also grateful to Mr. House for presenting the paper at the College Station meeting.

REFERENCES

1. J. G. Galway, "The Lifted Index as a Predictor of Latent Instability," *Bulletin of the American Meteorological Society*, vol. 37, No. 10, Dec. 1956, pp. 528-529.
2. R. G. Beebe and F. C. Bates, "A Mechanism for Assisting in the Release of Convective Instability,"

Monthly Weather Review, vol. 83, No. 1, Jan. 1955, pp. 1-10.

3. Hans Panofsky, *Introduction to Dynamic Meteorology*, The Pennsylvania State University, University Park, Pa., 1956, 243 pp. (pp. 54-56 and 100-102).

The
ganized
conduct
in orde
and bel
festatio
factors
variatio
directio
distribu
ant phe
relation
of origi
accompl
urement
of objec
nesses, a
graphs o
veys. P
in the f
The effe
and pub
also to b
The fir
Dallas t
was join
team, an

¹ Contribu
Meteorology
Oceanograph
tions condu
through the
tract Cwb-4
² Present

A SUMMARY OF EYEWITNESS INTERVIEWS¹

STUART G. BIGLER

Agricultural and Mechanical College of Texas, College Station, Tex.²

[Manuscript received June 26, 1958]

ABSTRACT

A brief résumé is given of the information gathered by personal interviews from eyewitnesses of the Dallas tornado of April 2, 1957.

1. INTRODUCTION

The Tornado Damage Survey Project was organized under Weather Bureau sponsorship to conduct investigations of the effects of tornadoes in order to establish knowledge of their structure and behavior as revealed by their various manifestations. Included for consideration were such factors as path length and course, path width and variations, distribution of horizontal velocities, direction of rotation, vertical velocities, pressure distribution, vertical structure, pertinent attendant phenomena, relation of path to terrain, and relation of the nature of the terrain at the place of origin to subsequent behavior. This was to be accomplished through specific quantitative measurements of structural damage and displacements of objects, accounts of interviews with eyewitnesses, and tornado and tornado-damage photographs obtained from both ground and aerial surveys. Publication of the information was to be in the form of raw data reports of each storm. The effectiveness of the tornado warning system and public reaction to tornado warnings were also to be evaluated in the study.

The first member of the survey team arrived in Dallas the morning following the tornado. He was joined in the afternoon by two more of the team, and 5 days later by three additional mem-

bers of the staff of Texas A. & M. College. A total of 44.5 man-days was spent in Dallas by this group to study the damage and collect data. Thirty-five tape-recorded interviews were obtained during this time.

During the entire investigation, close liaison was maintained with Weather Bureau personnel in Dallas. The Weather Bureau Office was used as headquarters and all survey personnel of both the Weather Bureau and Texas A. & M. stayed at the same hotel. Each evening a meeting was held, the results of the day's work discussed, and possible leads for further investigation exchanged. As a result of these discussions, some excellent witnesses who would otherwise not have been found were located.

INTERVIEW TECHNIQUE

It appears at first glance a relatively simple procedure to obtain information about tornadoes by speaking with persons who have experienced them. After some trial, however, it becomes evident that there is considerable skill involved in conducting damage surveys.

The preferred method developed during the investigation was the use of a long, informal, tape-recorded interview. A basic list of questions was constructed to insure inclusion of all important points in each interview. The correct phrasing of the questions was carefully considered as a safeguard against prejudicing the answers. It was found that questions calling for simple "yes"

¹Contribution from the Department of Oceanography and Meteorology, the Agricultural and Mechanical College of Texas, Oceanography and Meteorology Series No. 131, based on investigations conducted for the Texas A. & M. Research Foundation through the sponsorship of the U.S. Weather Bureau, under contract Cwb-9116.

²Present affiliation: U.S. Weather Bureau, Washington, D.C.

and "no" answers were not helpful in stimulating the witness to contribute details, and that questionnaires which the witness filled out in writing were not as informative as the oral interview in which the trained survey team members could

recognize significant material and follow through with pertinent questions.

The following remarks are based largely upon information derived from the published eyewitness accounts [1].

2. THE TORNADO AND ASSOCIATED WEATHER

THE TORNADO CLOUD

Several witnesses gave fairly good descriptions of the cloud associated with the tornado, particularly during its incipient stages. They all agreed that a thunderstorm was in progress north of the tornado. The parent tornado cloud itself however was described as being distinct, and quite different. *Each witness who watched the tornado develop described the tornado-bearing cloud as being a small one*, although the estimates of size did not agree. Such differences are to be expected, however, since it is very difficult to estimate cloud heights, thickness, and diameter. The largest estimate given was a cloud 1 mile in horizontal dimension. *The top of the cloud was described as being very diffuse, and not cumuli-form*, and it seemed to merge with an overcast at 6,000 feet. (One witness thought the cloud was only about 2,000 feet thick). Whether the cloud went above 6,000 feet could not be learned. It grew as it moved northward, and finally joined with the thunderstorm.

Mr. Winston Shelton, President of Tex-Air, Inc., who first reported the tornado to the Weather Bureau, said, "I noticed another cloud sort of in the shape of a cumulus but not a big buildup or anything like that. It had a dark base, but not a threatening base. The diameter didn't appear to be over a mile."

The base of the cloud was 600-800 feet above the ground during the early stages, but was estimated to be at 3,500 feet about midway in its life cycle.

THE FUNNEL

The first evidence of the funnel was a small "knot" protruding from the cloud base. Two other knots also appeared and finally merged into one funnel. The condensation funnel was visible throughout the storm, usually extending about one-half of the distance from the cloud base to

the ground. It apparently was on the ground only a short time, but an area of dust and debris was visible beneath the funnel. The photographs illustrate this well. The funnel was nearly vertical during most of its life. At times its tip tended to lag behind at the ground, and most witnesses felt that damage was not as great then. The funnel was about 50-100 feet wide at the tip according to most witnesses, but widened out and was considerably expanded at the cloud base. At one time during the early stages the funnel sloped about 45° toward the west.

The funnel apparently changed diameter quite rapidly, with at least one observer reporting noticeable changes taking place almost continuously. During dissipation, the funnel divided into at least two and possibly several parts. At this time the base and top of the funnel were separated (horizontally) by about 1 mile and the end was observed to "whip" in the air.

During the latter part of its life, light rain was reported in the immediate vicinity of the funnel; some witnesses got wet while watching it, or running from it.

A second funnel was observed at first approximately 1½ miles east of the Dallas tornado; the two gradually diverged. This second tornado later caused damage north of Dallas and was the funnel around which Mr. J. D. Hudson flew with a *Life* magazine photographer. An account of this flight was given wide distribution by the Weather Bureau [3].

PATH AND MOVEMENT

The first surface indication of the tornado was in an open field in the form of a whirlwind which increased in intensity as it moved northward. After traversing a path of about ¼ mile, it began to cause light damage such as breaking branches off trees and causing minor damage to houses. Considering the whirlwind to be the beginning,

the path
fined h
than w
feet, an
Width
ceeded
being s
tornado

Direct
north a
north-m
was cha
rection.
25 mile
near the
10 and
that the
it move

Nearl
ciated w
but end
passed t
with a n
which c
corded
over. H
occurred
tornado.
hail wer
on figur

None
close to
servers r
within t
ciated wi
static wa
and none

The flu
were less
derstorm
associated
or any o
airport h
fluence of
not be de

the path length was $14\frac{3}{4}$ miles. Path width (defined here as the width of tornadic winds rather than width of damage area) did not exceed 100 feet, and in most locations was only 60 feet wide. Width of damage along the path usually exceeded 100 feet, but this resulted from buildings being struck by flying debris rather than by the tornado itself.

Direction of movement was slightly east of north at first, but gradually altered toward the north-northwest. As shown in figure 1, the path was characterized by many small changes in direction. The speed of movement averaged about 25 miles per hour; however, witnesses driving near the tornado reported speeds varying between 10 and 40 miles per hour. Witnesses also reported that the tornado oscillated from side to side as it moved along.

PRECIPITATION

Nearly all witnesses reported heavy rain associated with a thunderstorm prior to the tornado, but ending 15 to 20 minutes before the tornado passed them. This precipitation was associated with a north-northeastward-moving thunderstorm which covered most of Dallas. Love Field recorded 0.36 in. in 5 minutes as the cloud passed over. Hail, usually reported to be of marble size, occurred with this thunderstorm, but not with the tornado. One or two reports of hen-egg-sized hail were also made. All hail reports are plotted on figure 1.

LIGHTNING

None of the witnesses reported any lightning close to the funnel, although two or three observers reported seeing a glow or dancing lights within the funnel. Some lightning was associated with the thunderstorm as it passed. Radio static was at a minimum in the broadcast bands and none was reported on the VHF channels.

PRESSURE

The fluctuations of the Love Field barograph were less than are usually observed during thunderstorms. No pressure jumps that could be associated with this tornado were evident on this or any other barograph in the area. Since the airport had been in the heavy rain area, the influence of the tornado on the pressure trace cannot be determined with certainty.

Through most of the Oak Cliff area little damage resulting from pressure change alone could be found. A movie theater wall collapsed, probably from pressure differential, but not until the tornado reached the north end of its path was there any further evidence of heavy damage due to pressure variations. Homes in the Oak Cliff section which lost rooftops did not appear to have been affected seriously by pressure. In those homes where a careful examination was made, all window damage could be accounted for by flying debris, since the windows usually had holes in them rather than having the full pane out. Some witnesses noticed their ears "popping," while others did not.

Mr. John Geyer, a Weather Bureau employee, reported hearing a child's rubber duck honk on two separate occasions as the tornado passed within one-half block of his house. This is particularly significant since the toy honks only when air is being expelled from it (as on the passage of a low-pressure area) and not when air is entering.

SOUND

The sound of the tornado was described both as a steady and as a pulsating noise. The pulsating quality may have been partly the result of suddenly added noise as buildings were torn apart. Most reports characterized it as a loud roar like the approach of many trains or jet planes.

WIND

With respect to the wind in the vicinity of the funnel, witnesses agreed that the wind was calm to distances about a mile from the tornado. Several who were very close, including one man within 50 feet of the damage area, also reported feeling no wind. In this regard, the observations over Bachman Lake are very interesting. Neither of the two observers who were within 300-400 feet reported seeing any rippling of the water surface except in the area where the tornado funnel was actually touching the lake, indicating that the wind is sharply discontinuous at the funnel and need not decrease gradually with distance from the funnel as most investigators have represented; and that inflow, at least at the surface, was insignificant at this point in the tornado path. The tornado was dissipating at this point in its path.

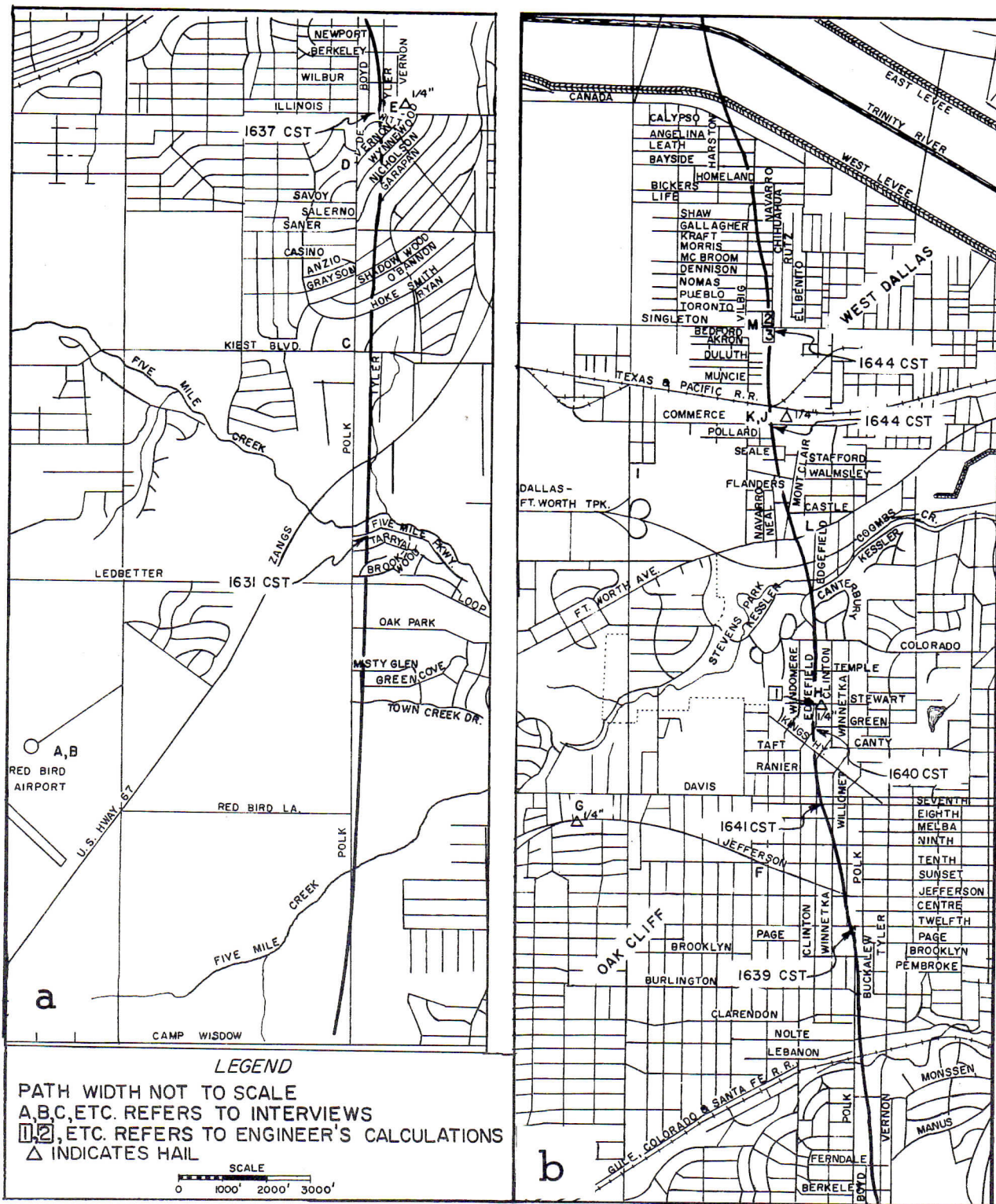

FIGURE 1.—Southern (a), middle (b), and northern (c) sections of the path of the Dallas tornado, April 2, 1957.

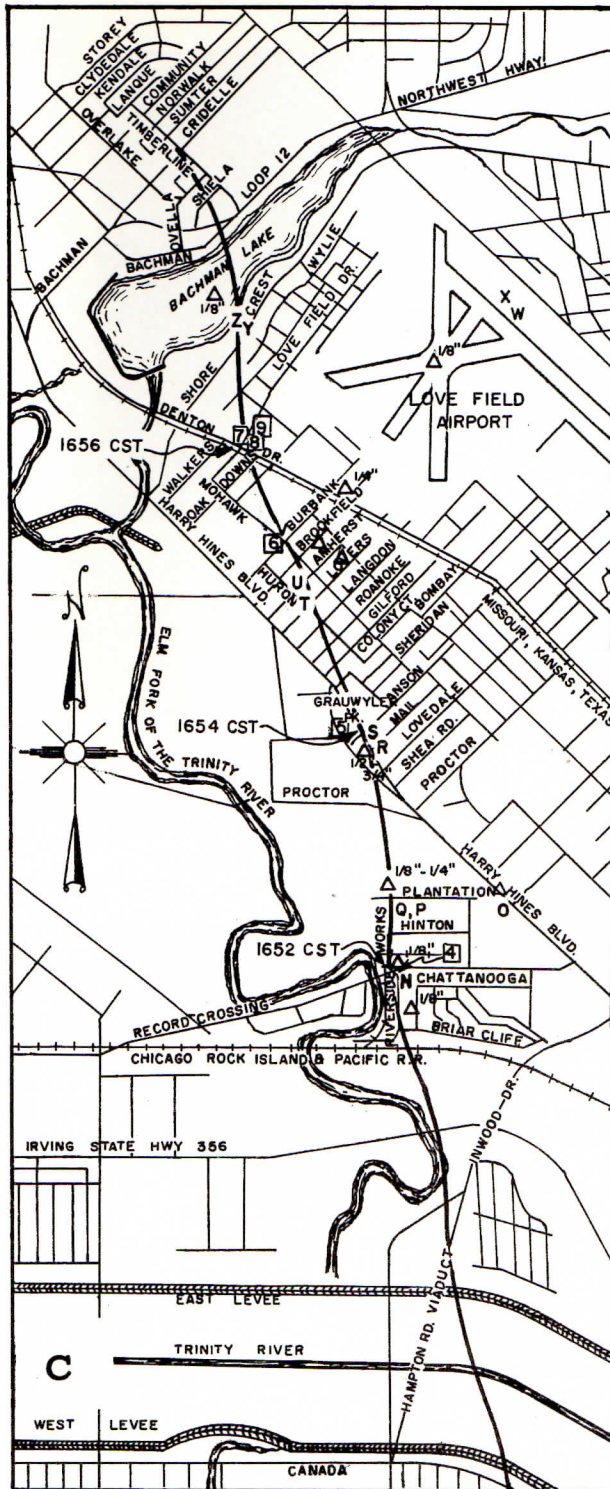

FIGURE 1.—Continued

The movies of the tornado show rapid fluctuations in the motions within the dust and debris area which indicate a variable wind around the base of the funnel.

While most witnesses described the action of the wind as being one of suction, several felt that it was just the opposite. Robert Huber, Dallas Police Department, volunteered the following:

The debris seemed to go away from the funnel. Now that I get to thinking about it, if you are standing out watering your lawn and you squirt your hose down and the debris and stuff that you hit with the water pressure goes away from it, that's what it looked like it was doing. The vapor from the funnel itself and from the bottom of the funnel looked like the stuff was rolling out like this, and around in a circular direction. . . . It was rolling up from the bottom and instead of coming from the outside in, it looked like it was maybe coming from the inside out. Like if you hold a steam hose at the ground, and let the steam out, the steam is going to come out away from the hose in a kind of rolling, circular motion.

Another witness reported the ashes in her fireplace blown around the house, yet all doors and windows were shut. The wind could only have come down the flue.

Mr. A. M. Brown watched the tornado cross Bachman Lake from a good vantage point and reported "to the best of my knowledge, it just opened up a hole, and you could see right to the bottom, it looked like." He also stated that the hole was 18-20 feet deep and about 40 feet wide.

In contradiction to their comments concerning suction most witnesses described all debris at the ground level as moving away from the funnel and none actually approaching it. For instance, according to Mr. B. G. Harris, "it seemed to me like it [debris] was coming out from the ground at an angle just like something had caught hold of it and slung it out." Movies of the funnel confirm these observations.

Considering also the significance of Mr. Geyer's observations concerning the honking of the rubber duck, the suggestions repeatedly advanced, that the tornado funnel might possess a central downdraft, should not be lightly dismissed.

Engineering estimates of forces required to cause damage (described in another section of this report) generally indicated winds under 150 miles per hour. One of two estimates which exceeded this value was based on the overturning

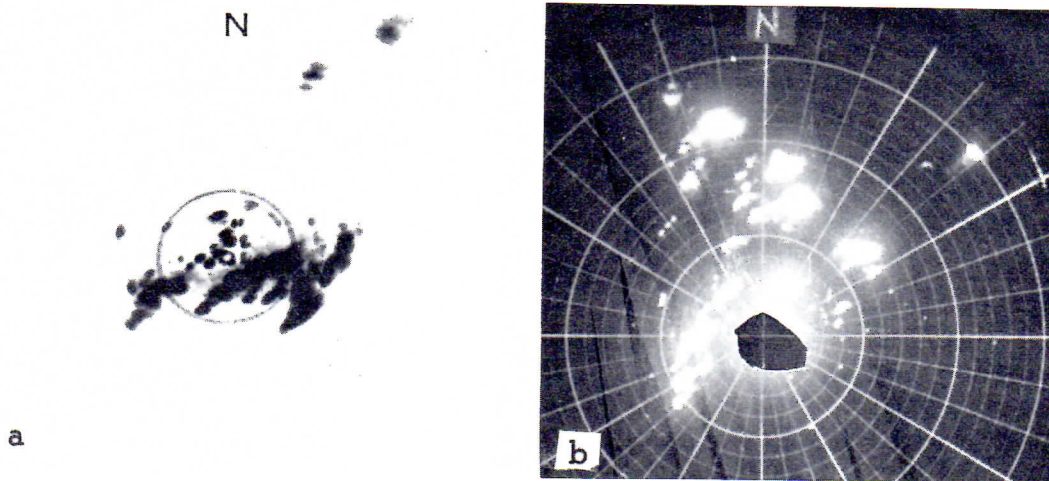

FIGURE 2.—Radar echoes associated with Dallas tornado: (a) Before funnel formation, (b) just after the funnel lifted. (Radars at different locations.)

of an empty railroad box car which two witnesses independently described as being lifted on end as the tornado passed. Damage to the top and frame of the car confirmed the observation. Judging by the original position of the car and the tornado path, this car was closer to the center of the funnel than any of the other cars. An aerial photograph, one of a series made by the Texas A. & M. damage survey team and reproduced as Photo 22b on page 45, shows the overturned railroad cars.

TURBULENCE

Several pilots flew close to the tornado funnels. One, flying a commercial aircraft, reported no turbulence at his distance of 3-4 miles from the Dallas tornado funnel. Another flew to within about 800 feet of a second funnel. He reported only light turbulence at this distance. A third pilot who was making an approach to Redbird Airport flew in the vicinity of the tornado cloud just before the first funnel became visible. He too did not notice any turbulence.

RADAR OBSERVATIONS

The tornado was observed on the GCA radar at Love Field, and by several other radars in the

area. Unfortunately, none of these photographed their scopes during the actual period that the tornado was on the ground. The Weather Bureau station at Fort Worth took pictures before and after the storm using a 100-mile range setting. Figure 2a shows a picture taken before the storm, and figure 2b is a picture taken by a different radar minutes after the funnel had lifted. Movement of the echo was toward 010° at 24 knots. These pictures show that the tornado was located on the southwest side of an echo, the same as is usually observed. The northward movement of the echo placed the tornado in the left rear quadrant of the echo with respect to motion. Tornadoes have been most frequently observed in the right rear section of the echo [2].

The GCA operator made some interesting observations of the second tornado. A commercial aircraft outbound from Love Field reported the funnel to the radar operator and supplied information concerning its touchdowns and path. Each time the pilot reported a touchdown, the radar operator observed an echo on his scope in the location described by the pilot. The echo was similar in appearance to that of an aircraft except that it was only intermittently observed.

For t
excessive
parative
Heavy
was lim
construc
(See ph

Descri
ing are
of the
described
to the si
roof wo
blow alo
tornado,
pear as a

Mr. E
nado an
said "I s
go togeth
go togeth
reached

the top o
The me
was the
solid mas
of this ty
extensive
common
construct
outer laye
slab on th
fell outwa
Renard F

one which
sides, incl
ing away
into the b
side the ru
box car ov
the debris
turned at
lapsed. T
appear to
ing of the
subjected t
the same t
pressure d

3. DAMAGE TO STRUCTURES

For the most part, the tornado did not cause excessive damage, and must be considered a comparatively mild one by almost any standard. Heavy damage, except for masonry buildings, was limited to areas of inexpensive and flimsy construction, where damage was nearly complete. (See photo 19a on p. 39.)

Descriptions by witnesses of buildings collapsing are very interesting. Persons to the north of the funnel, watching it come toward them, described the buildings as exploding; but people to the sides or behind the funnel related that the roof would go up, then the other walls would blow along the path. To persons ahead of the tornado, this sequence in disintegration could appear as an explosion.

Mr. Ed Hite who drove along behind the tornado and watched several buildings destroyed said "I saw several of them. I could see the roof go together, and go up, and the walls cave in or go together, just kind of like a giant hand had reached out and pinched the thing and popped the top off of it."

The most obvious feature of structural damage was the tornado's effect upon buildings having solid masonry wall construction. Most buildings of this type in the path of the tornado suffered extensive damage as the walls collapsed. The common type of masonry wall encountered was constructed of 8-inch concrete blocks with an outer layer of 4-inch bricks and a 1-inch gypsum slab on the inside. The walls of these buildings fell outward and toward the tornado path. The Renard Rug Co. (fig. 3) building was the only one which suffered damage to the walls on three sides, including the wall on the side of the building away from the tornado. This wall (A) fell into the building and toward the tornado. Outside the rug company building, an empty railroad box car overturned toward the path. Judging by the debris around the car, it must have overturned at nearly the same time as wall (C) collapsed. The force of the falling wall did not appear to have aided materially in the overturning of the car. This suggests that wall (C) was subjected to an inward wind force at very nearly the same time that it fell outward because of a pressure differential.

The survey team was constantly on the alert to locate adjoining buildings of different construction which might have been subjected to the same forces, but suffered different degrees of damage. Before establishing that the buildings were subjected to the same forces, it is necessary to consider several factors which were in operation, such as (1) the eyewitness descriptions of side-to-side oscillations of the funnel at the ground, (2) the amount of ventilation in the house (number of open windows, and direction relative to the storm of open windows, whether attic fans were operating, tightness of construction, whether or not the house was built on a slab foundation, etc.), and (3) the effect of local eddies. A few cases were found in which it appeared that approximately the same forces were involved. In one instance, an old house was totally destroyed, while adjoining houses of equal age suffered only minor damage. The former was what might be called a "cracker box", the exterior walls containing no studs. Both of the adjoining houses had studs in the walls. Figure 4 shows both of these houses. Frame houses across the street from the Renard Rug Co. and some near a movie theater in Oak Cliff suffered extensive roof damage only, but the walls of the rug company and movie theater were masonry and collapsed as the tornado passed. In both buildings the walls were also supporting the roof so that the roof fell in, thus causing even more extensive damage. The forces required to cause failure of these masonry walls have been calculated and are included in the engineer's report.

In the Riverside Drive area, where some of the most extensive damage occurred, the exterior walls consisted of sheetrock on the inside and asbestos shingles nailed to slats on the outside. These houses were one-story apartment units with three or four units comprising one building. These were totally destroyed, even the first floor being gone. All of these buildings had been bolted to the foundation with bolts at 5-foot intervals. The bolts and 2×4 plates containing them were still in place.

A characteristic sequence of damage to frame houses became apparent during the damage survey. Porch roofs and shingles were most com-

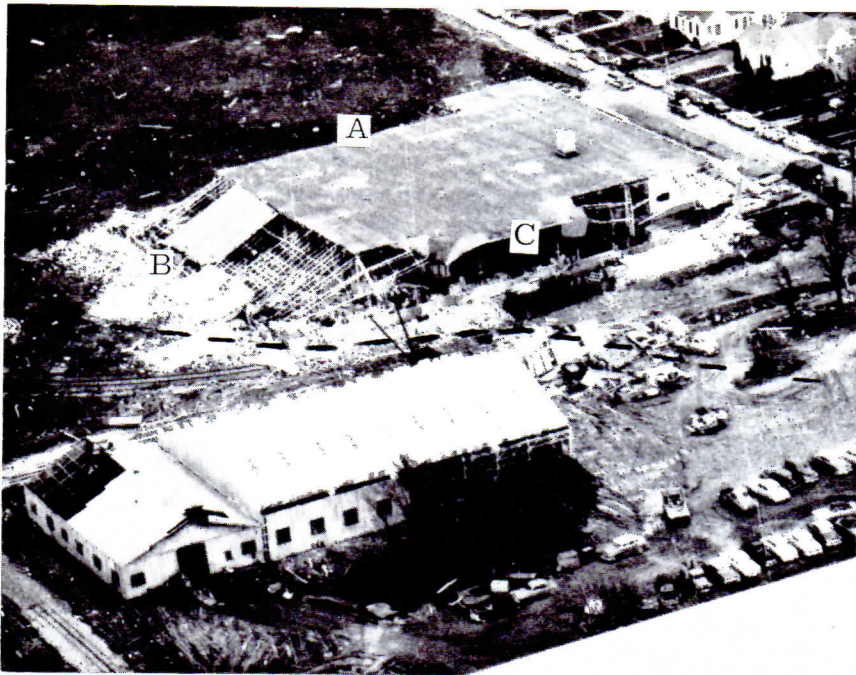

FIGURE 3.—Damage to a building of solid masonry wall construction. Labels A, B, C, refer to walls discussed in text. Dashed line shows approximate path of tornado, moving toward the left.



FIGURE 4.—Complete destruction of wooden house constructed with no studs in the outside walls. Undamaged house next door was of approximately the same age.

monly
destru
ousnes
roofs.
roofs,
from
The co
ones in
age cu
even th
away.

In st
modes
and th
disting
the int
tion ou
walls o

The c
was ma
both of
path we
were ta
camera.
window

Witne
thought
favoring
bered, h
tioned h
ence or
ceptance
found if

To the
people, w
should d
A great
they hap
west corn
probably

monly damaged and constitute the least serious destruction. Next in order of frequency and seriousness was the removal of roofs or portions of roofs. In some cases, especially with hipped roofs, a roof section, usually on the side *away* from the approaching tornado, was taken off. The collapse of exterior walls, leaving the inner ones intact, constituted increasingly serious damage culminating finally in total destruction when even the lower floor with all partitions was blown away.

In studying damage to structures, two general modes of collapse, one typical for frame houses, and the other for masonry structures, could be distinguished. Masonry buildings responded to the internal force caused by the pressure reduction outside of the building, which pushed the walls outward and allowed the roof to fall in

(fig. 3), while frame houses with more ventilation and therefore more possibility for equalization of pressures, showed rather the struggle to resist the sheer driving force of the wind. In the latter, the roofs were ripped off by wind motion, and the walls blown over and strewn along the tornado path. Masonry walls, exhibiting more rigidity, acted as a unit and were pushed over at once, while frame construction could give and was therefore not so frequently seriously damaged.

One eyewitness who is a consulting engineer said that the building damage in Dallas indicated to him that the destructive forces were about the same as those in the Waco, Tex., tornado in 1953 and the Drumwright, Okla, tornado of 1956. He had surveyed the damage after both storms for insurance companies.

4. AERIAL SURVEY

The day following the tornado, an aerial survey was made with Robert Beebe and Alton Duff, both of the U.S. Weather Bureau. Movies of the path were made by Mr. Beebe, and still pictures were taken by the author using a K-20 aerial camera. All pictures were made through the side windows of the aircraft and some loss of defini-

tion resulted. Flight altitude was between 500 and 600 feet above ground.

The data from this flight made it possible, by identifying streets in each picture, to plot the exact path of the storm. No scoring of the ground by heavy objects dragged around by the tornado was evident from the air.

5. PUBLIC REACTION TO TORNADO FORECASTS

Witnesses were unanimous in stating that they thought tornado forecasts were beneficial and in favoring their continuation. It should be remembered, however, that most of the people questioned had just had a rather harrowing experience or a narrow escape, and such complete acceptance of the forecasts might not have been found if a tornado had not occurred. The ma-

ajority of witnesses seemed to realize that there is a real possibility of a tornado occurring outside of a forecast area. It might be that radio and television stations are at fault in trying to minimize the danger present when the local town is in proximity to, yet not actually within the bounds of, a tornado alert area.

6. GENERAL KNOWLEDGE OF PERSONAL SAFETY PRECAUTIONS

To the surprise of the survey team, very few people, when questioned closely, knew what they should do to protect themselves during a tornado. A great many lay down on the floor wherever they happened to be. Others thought the southwest corner of their house to be the safest place, probably a result of hearing that the southwest

corner of basements is considered safe. Others in automobiles stopped their cars and tried to run away, when they could have easily driven away. It seems that people consider the likelihood of personally experiencing a tornado a remote possibility, and consequently adopt the attitude, "Why learn the rules?"

7. SUMMARY

The preceding remarks should serve to emphasize certain points about the tornado which became evident through interviews. Each item is only briefly discussed, and more complete information is contained within the original report [1]. To those interested in tornado models and structure, careful study of the statements in the interviews and the implications of some of the

comments should yield some excellent material. Some of the observations do not support classical theories of tornado structure but this information should not be ignored. It should be remembered that most witnesses have very little interest in the scientific study of tornado origin and behavior; they are merely relating what their experiences were and what they saw.

REFERENCES

1. S. G. Bigler, "The Dallas Tornado of 2 April 1957," *Scientific Report No. 2*, on Contract Cwb-9116, Department of Oceanography and Meteorology, Agricultural and Mechanical College of Texas, College Station, Tex., August 1957.
2. M. G. H. Ligda, S. G. Bigler, R. D. Tarble, and L. E. Truppi, "The Use of Radar in Severe Storm Detection, Hydrology, and Climatology," *Final Report* U.S. Weather Bureau Contract Cwb-8716, Department of Oceanography and Meteorology, Agricultural and Mechanical College of Texas, College Station, Tex., October 1956.
3. U.S. Weather Bureau, Memorandum to all first order stations June 10, 1957.

This
require
ures th
April 2
from a
each ca
maxim
upon r
Althou
tions re
have co
relative
In s
from th
occurre
choosing

¹ Present
Meteorolo
American
Civil Engi

ESTIMATES OF MINIMUM WIND FORCES CAUSING STRUCTURAL DAMAGE^{1,2}

E. P. SEGNER, JR.

Assistant Professor of Civil Engineering,
Agricultural and Mechanical College of Texas, College Station, Tex.

[Manuscript received September 7, 1958]

ABSTRACT

The results of computations of the minimum wind speeds required to produce the damage observed to various kinds of structures during the Dallas tornado are presented. The highest speed computed is 302 miles per hour. Because of the limitations, these computations are of most value as indicators of relative magnitudes of the wind speed.

1. INTRODUCTION

This paper will show the minimum wind speeds required to produce some of the structural failures that occurred during the Dallas tornado of April 2, 1957. The wind speeds were determined from an analysis of many types of structures. In each case the minimum or, in a few cases, the maximum wind speed computations were based upon reasonable sequences or modes of failure. Although the results are limited by the assumptions required by the analysis, it is felt that they have considerable value as an indication of the relative magnitude of the wind speeds involved.

In selecting items for engineering analysis from the great number of interesting and unique occurrences present, consideration was given to choosing only those for which sufficient and perti-

nent information was available to make the engineering estimate reasonable and reliable. Naturally, some of the sites yielded an estimate much more trustworthy than others, due to the extent of the damage and obvious sequence of events, the helpfulness of the eyewitnesses' reports, the type and quality of construction, and the availability of wind tunnel data. Another factor which had to be considered was whether or not the damage resulted from actual wind forces or from flying objects. This, in some cases, was impossible to determine. It is necessary to keep in mind the factors which have been mentioned and to realize that, in each case, the speeds are probably somewhat in error and represent only a reasonable estimate at best.

¹ Presented before the Second National Conference on Applied Meteorology: Engineering, under the joint sponsorship of the American Meteorological Society and the American Society of Civil Engineers, Ann Arbor, Mich., September 9-11, 1959.

² Contribution from the Department of Oceanography and Meteorology, the Agricultural and Mechanical College of Texas, Oceanography and Meteorology Series No. 158, based on investigations conducted for the Texas A. & M. Research Foundation through the sponsorship of the U.S. Weather Bureau, under contract Cwb-9116.

2. ESTIMATES

ITEM NO. I

Collapse of two walls of a service station located on the corner of Stewart and Edgefield Streets in southeast Dallas

(Fig. 1)

The walls A and B were blown outward at this location. Both walls were constructed of 8-inch concrete blocks and had a clear ceiling height of 12 feet. The minimum computed speed to collapse walls A and B was approximately 92 miles per hour. Of course, this estimate assumes sound original construction, which may or may not have been present, as the general character of masonry construction makes pinpoint analysis impossible. This is especially true where combined bending and axial loading is involved.

ITEM NO. II

Overturning of a small empty storage tank at Davison Oil Co., 1616 Singleton Boulevard

(Fig. 2)

This tank was overturned and was seen by eyewitnesses to roll for over 100 feet along the ground after overturning. This analysis determined only minimum wind speed required to overturn, assuming the legs were not anchored. The minimum wind speed required to produce this overturning action was between 55 and 65 miles per hour; however, it should be kept in mind

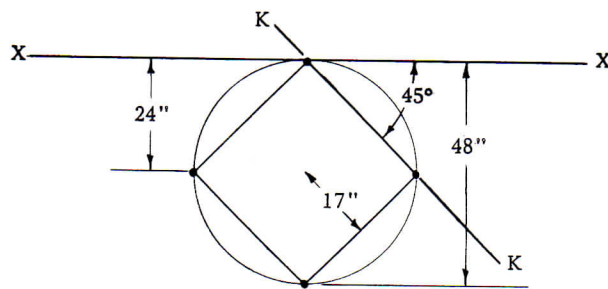

FIGURE 1.—Plan view of building, item no. I.

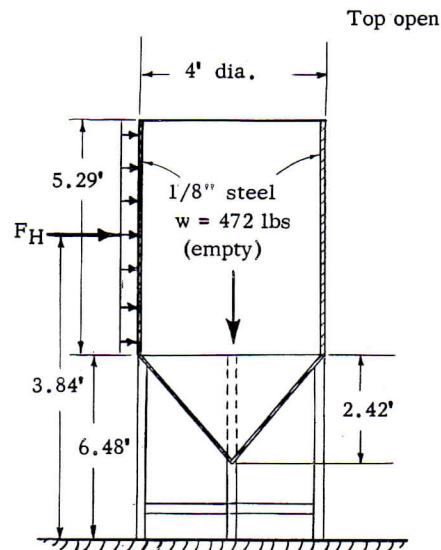

FIGURE 2.—Plan and elevation views of tank, item no. II. Support consists of four legs and four horizontal braces. All are $1\frac{1}{2}$ by $1\frac{1}{2}$ by $\frac{3}{16}$ -inch angles.

that the tank actually was blown along the ground for some distance after overturning, which might indicate that, perhaps, a much higher wind was present. Since the legs were not anchored, the tank may have been subject to gust action.

ITEM NO. III

Removal of the flat roof of a building owned by Mr. A. Ragland, at 3013 Navarro, on the corner of Navarro and Singleton Boulevard

(Fig. 3)

In this item the built-up roof of the two-story building was completely blown off, including the 10-inch shiplap. The roofing material was un-

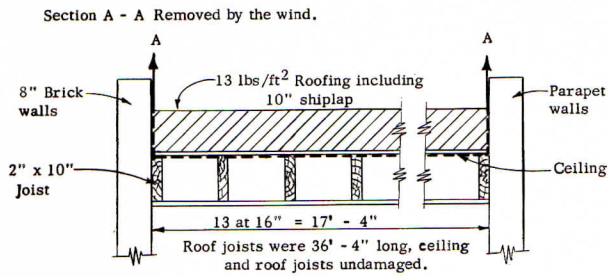

FIGURE 3.—Elevation of roof section, item no. III.

usually heavy for this type of construction, being approximately 13 pounds per square foot. None of the supporting roof joists below, nor the ceiling carried by the roof joists, was damaged. Thus, it appears that only external wind suction was involved. In the analysis, only 50 percent of the attaching 20d common nails were assumed to be effective in resisting this uplift, since the roof joists themselves were not damaged. It should be kept in mind that this is only an approximation at best, but it is considered to be reasonable in view of the information available; therefore, the minimum wind speed required to cause failure, in the manner described, was computed to be at least 179 miles per hour. Of course, the chief error involved in these calculations relates to the type of end connection involved and its particular manner of failure.

ITEM NO. IV

Overturning of railroad freight cars at Record Crossing Switch on the east side of the Trinity River

(Fig. 4)

At this location several railway freight cars were overturned by the force of the tornado.

CAR 1 was overturned sideways to the west and at the time of overturning had gross weight, without the trucks, of approximately 108,600 pounds. Both of its side doors were closed. The minimum speed required was 128 miles per hour.

CAR 2 remained in an upright position and had a loaded gross weight of 119,300 pounds at the time, with both of its doors open. This does not include the weight of its trucks, which weighed a total of 10,000 pounds. The trucks were dropped. The minimum speed required to overturn was 144 miles per hour; therefore, if

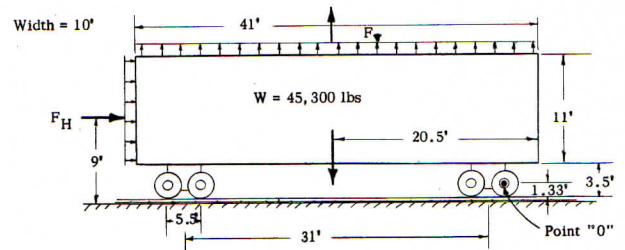
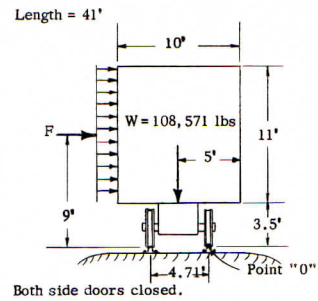

FIGURE 4.—(Above) End view of car I, item no. IV. (Below) Elevation of car IV, item no. IV.

the assumptions made are correct, it can be concluded that the horizontal wind in the vicinity of cars 1 and 2 was between 128 and 144 miles per hour.

CAR 3 was directly south of car 2 and of similar position and weight; therefore, the horizontal wind speed was less than 144 miles per hour.

CAR 4 was reported by an eyewitness to have been located south of car 6 and to have overturned endwise with a center rotation about one end. This car was empty and had a gross weight of approximately 45,300 pounds, excluding the weight of the trucks, which remained on the ground. The doors on each side of the car were open. It should be kept in mind that the values obtained from the analysis of this item were very approximate in nature as the shape factors used in the calculations are only estimated average values and vary greatly with the shape and relative size of each structure. Exact values can be determined only by wind tunnel test for the particular item concerned. The minimum speed required to produce this overturning action was calculated to be 217 miles per hour.

CAR 5 was empty having a gross weight of 45,300 pounds excluding the weight of the trucks which were left on the ground as the car turned

sideways to the east. Only one of its doors was definitely known to have been open; therefore, the other door was assumed to have been closed. The minimum computed wind speed was 83 miles per hour.

CAR 6 was overturned sideways to the east with both of its doors open at the time and had a gross weight of 119,300 pounds. The minimum horizontal speed required to overturn was 144 miles per hour.

CAR 7 had a loaded gross weight, including its trucks, of 72,400 pounds and overturned sideways to the east. Both of its doors were closed. The minimum computed required speed was 105 miles per hour.

CAR 8 had a loaded gross weight, including weight of its trucks, of 135,600 pounds and remained in an upright normal position. The door on the west side was open while the door on the east side was closed. The minimum computed speed to produce overturning was 143 miles per hour; therefore, the actual wind velocity was probably less than 143 miles per hour since it remained upright. Since only one door was closed, it should be remembered that the exactness of any calculations would be very approximate without wind tunnel tests.

ITEM NO. V

Structural collapse of a 45-foot elevated signboard located on the west side of Harry Hines Boulevard in the 7400 block

(Fig. 5)

This structure consisted of 13 poles extending 45 feet above ground. The horizontal bracing was in the elevation between 28 feet and 45 feet only, above the ground level, and was of unknown character. Since the dispensation of the bracing was approximated, the exact sequence of failure was unknown. Therefore, several conceivable sequences of failure were considered with the lowest minimum speed computed being 302 miles per hour. In this case it was assumed that the bracing and face of the billboard itself failed first, and then each pole, stripped of all other components of structure, failed independently, due to the wind pressure of its own vertical surface along its full height.

In view of this high value of the minimum wind speed and considering the other minimum speeds computed for different situations, it would

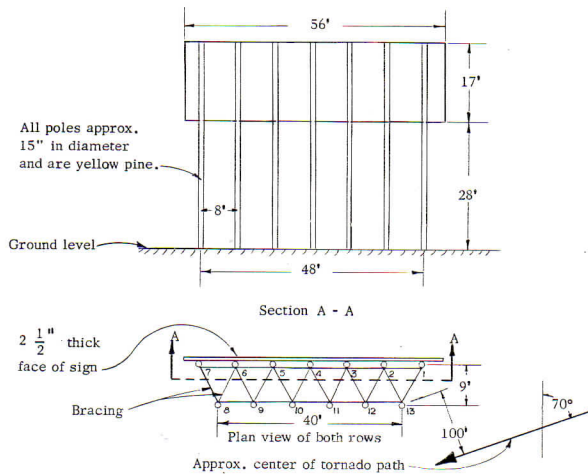
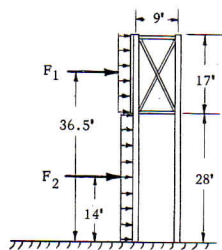

FIGURE 5.—End elevation of sign (above), front view (center), and plan view of sign, item no. V.

seem very doubtful that a single mode of failure occurred. Rather it is more likely that a combination of failures actually took place, thus making possible a reduced speed to account for the damage. The possibility of destruction from flying objects should not be overlooked because of the distance from the damage and proximity of other structures which were not severely damaged. Another consideration to be noted is that, if the calculated speed of 302 miles per hour is regarded as a reasonable value, the speed of the wind at the ground level could have been much less since the large resisting face of the sign was between 28 and 45 feet above the ground.

ITEM NO. VI

Structure failure of 12-inch masonry walls on three sides at Renard Linoleum & Rug Co., 2335 Burbank Street

(Fig. 6)

In this structure, three of the four vertical walls failed as shown, with the wall D remaining

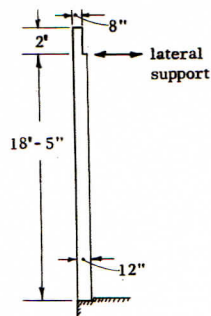

FIGURE 6.—Elevation of wall and plan view of building, item no. VI.

intact. All walls were 12-inch masonry construction consisting of 8-inch lightweight concrete block interlaced by 4-inch brick. The clear height of all walls was 18 feet 5 inches. The computed minimum speed of collapse for walls A and C was 107 miles per hour, while that for wall B was 109 miles per hour. Of course, these values assume no secondary failure of either wall which might occur if failure of all walls was not simultaneous. In addition, it might be noted that, if a so-called "down draft" existed in the vicinity of this building, this downward vertical pressure on the roof would have enabled the walls to withstand a much greater pressure differential before failing than the figures indicate. Of course, the magnitude, or even the existence, of this factor is not known; therefore, it cannot be considered here.

ITEM NO. VII

Overturning of an empty truck bed and attached hoist at corner of Denton Road and Wyman Street

(Fig. 7)

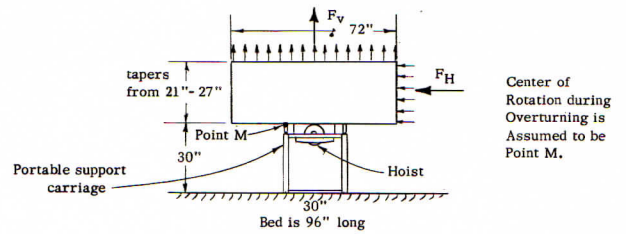

FIGURE 7.—Front elevation of truckbed, item no. VII.

This item consists of a 3-yard truckbed and its attached hydraulic hoist which was overturned by the wind force while resting on a portable support carriage about 30 inches off the ground. The bed and the hoist were overturned about an axis parallel to its longitudinal axis. In the analysis, the wind force was considered to have been composed of vertical uplift as well as horizontal pressure. In interpreting the results obtained by this method, it should be kept in mind that this value is only approximate in nature since estimated shape factors were used. No horizontal slippage was possible. Based on this analysis the minimum wind speed required to overturn the truck and attached hoist was approximately 123 miles per hour.

ITEM NO. VIII

The yielding of a flagpole in front of the Johnson & Johnson Co., 9000 Denton Drive

(Fig. 8)

This flagpole, located in front of the Johnson & Johnson Administrative Building on the east side of Denton Drive, was composed of three telescoped sections of pipe having a total height of 42 feet. The pole was embedded in concrete for a length of 6 feet which was undisturbed by the tornado. This coupled with the fact that the stresses in the portion of the pole above the ground remained in the elastic range, as evidenced by its straightness when measured afterward, would seem to indicate that all of the permanent deformation occurred at its base; that is, at the top of the concrete base. The final angle of deviation off the vertical was $1^{\circ} 30'$. Assuming a yield point stress of 35,000 p.s.i., the minimum wind speed required to produce this stress

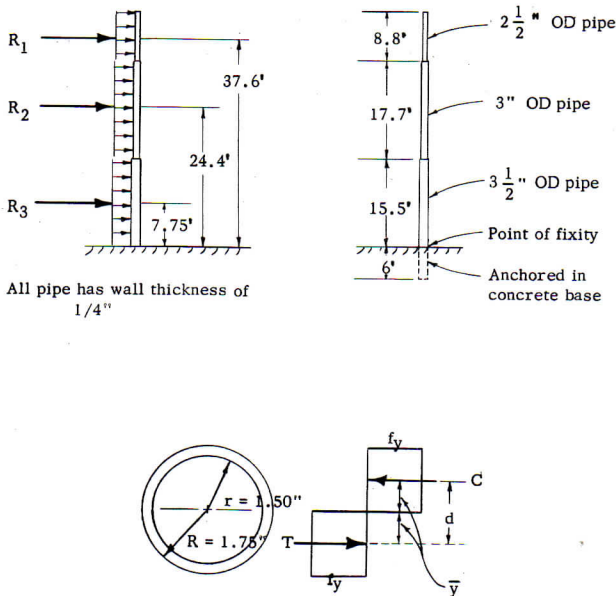

FIGURE 8.—Dimensions of flagpole (above), and stress distribution in pole, item no. VIII.

would be between 115 and 133 miles per hour. It might be added that the writer feels that these values are quite accurate and can be taken as being a very reliable indication of minimum wind speeds encountered.

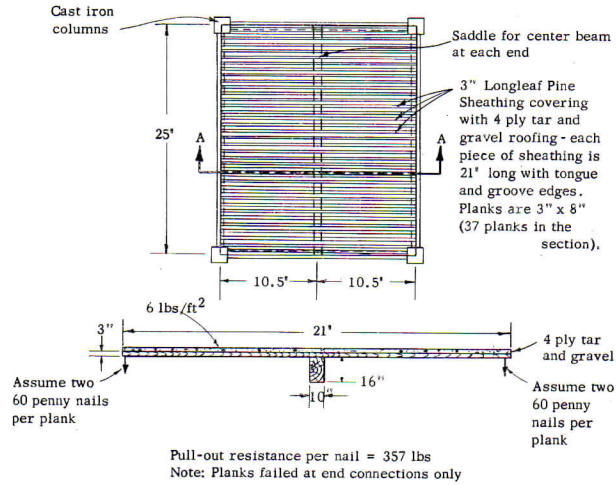

FIGURE 9.—Plan and elevation views of roof, item no. IX.

ITEM NO. IX

Roof damage to Johnson & Johnson Co. warehouse at 900 Denton Drive

(Fig. 9)

This item consists of a hole in the roof of the Johnson & Johnson Co. warehouse which was the result of either external suction or internal pressure. The roof section considered was approximately 21×25 feet. The roof portion consisted

TABLE I.—Summary of estimated wind speeds in Dallas tornado

Item No.	Location	Item description	Estimated speed (miles per hour)
1	Corner of Stewart and Edgefield Sts.	Service station wall collapse (12 feet high):	
		(a) Collapse outward of south 8-inch concrete block wall.....	91.6 (minimum).
		(b) Collapse outward of west 8-inch concrete block wall.....	92.2 (minimum).
2	1616 Singleton Blvd.....	Overturning of 48-foot diameter empty tank on 3-foot 10-inch legs:	
		(a) With single leg as center of rotation.....	65.5 (minimum).
		(b) With pair of adjacent legs as center of rotation.....	55.2 (minimum).
3	Corner of Navarro and Singleton Blvd.	Uplift of roof section from flat-roofed 2-story structure.....	179 (minimum).
4	Record Crossing on east side of Trinity River.	Overturning, or near overturning, of 8 railway freight cars:	
		Car I.....	128 (minimum).
		Car II.....	144 (maximum).
		Car III.....	144 (maximum).
		Car IV.....	217 (minimum).
		Car V.....	83 (minimum).
		Car VI.....	144 (minimum).
		Car VII.....	105 (minimum).
		Car VIII.....	143 (maximum).
5	7400 Block of Harry Hines Blvd.....	Failure of 13-pole, 45-foot elevated signboard. Independent failure of each pole assumed critical.	302 (minimum) (very doubtful).
6	2335 Burbank.....	Structural failure of 12-inch concrete block walls of 18-foot height:	
		(a) Southwest wall outward.....	107.4 (minimum).
		(b) Northwest wall outward.....	109.3 (minimum).
		(c) Northeast wall inward.....	107.4 (minimum).
7	Corner of Denton Rd. and Wyman St.	Overturning of empty truck bed and hoist.....	123 (minimum).
8	9000 Denton Rd.....	Yielding of flag pole in front of Johnson & Johnson Co.:	
		(a) Assuming elastic action.....	115 (minimum).
		(b) Assuming plastic action.....	133 (minimum).
9	9000 Denton Rd.....	Removal of roof section from Johnson & Johnson warehouse.....	189 (minimum).

of 3-inch longleaf pine sheathing covered with a four-ply tar and gravel roofing. In the analysis, only 50 percent of the nails at each end of each sheathing plank were assumed to be effective in pull-out. The minimum pressure differential to cause failure of the roof section above was approximately equivalent to a windspeed of 189

miles per hour; however, this value would be subject to great change with any change in the type of connection failure assumed. Since the exact type of connection failure is unknown, this value must be considered, at best, only a rough estimate; however, it is probably correct within 25 percent.

ACKNOWLEDGMENTS

The author would like to acknowledge the support and assistance given him by the Department of Oceanography and Meteorology at Agricultural and Mechanical College of Texas. Particularly is he indebted to Professor Stuart G. Bigler. If the reader would like a more detailed report including calculations, he may secure the full formal report that was prepared jointly by

Professor Bigler and the writer for the Department of Oceanography and Meteorology at A. & M. College of Texas entitled "The Dallas Tornado of 2 April 1957", *Scientific Report No. 2*. This research was conducted through the Texas A. & M. Research Foundation and sponsored by the U.S. Weather Bureau under Contract No. Cwb-9116.